

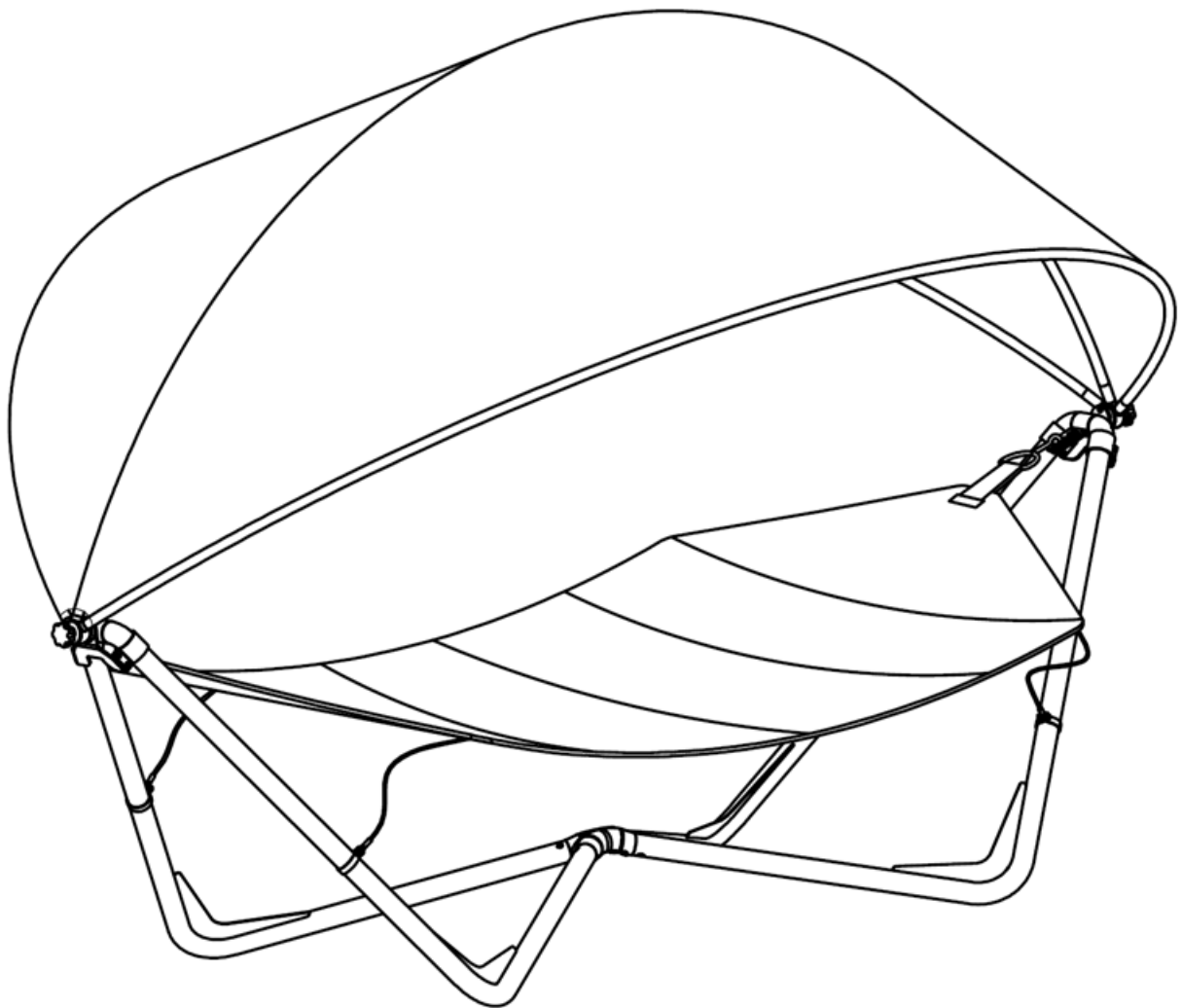















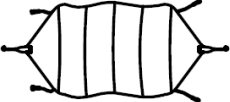







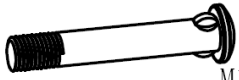

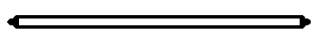

AUFBAUANLEITUNG HÄNGEMATTE



REF	BILD		REF	BILD	
1		2	17	 M8	8
2		2	18	 M8*20	8
3		1	19		4
4		2	20		4
5		1	21		1
6		4	22		2
7	 M6*20	4	23		2
8	 M6	4	24		4
9	 M10*65	4	25	 M5*10	6
10	 M10	4	26		1
11	 $\phi 10 \times 1.0$	4	27		2
12		4	28		1
13		2	29		1
14		2			
15		2			
16		2			

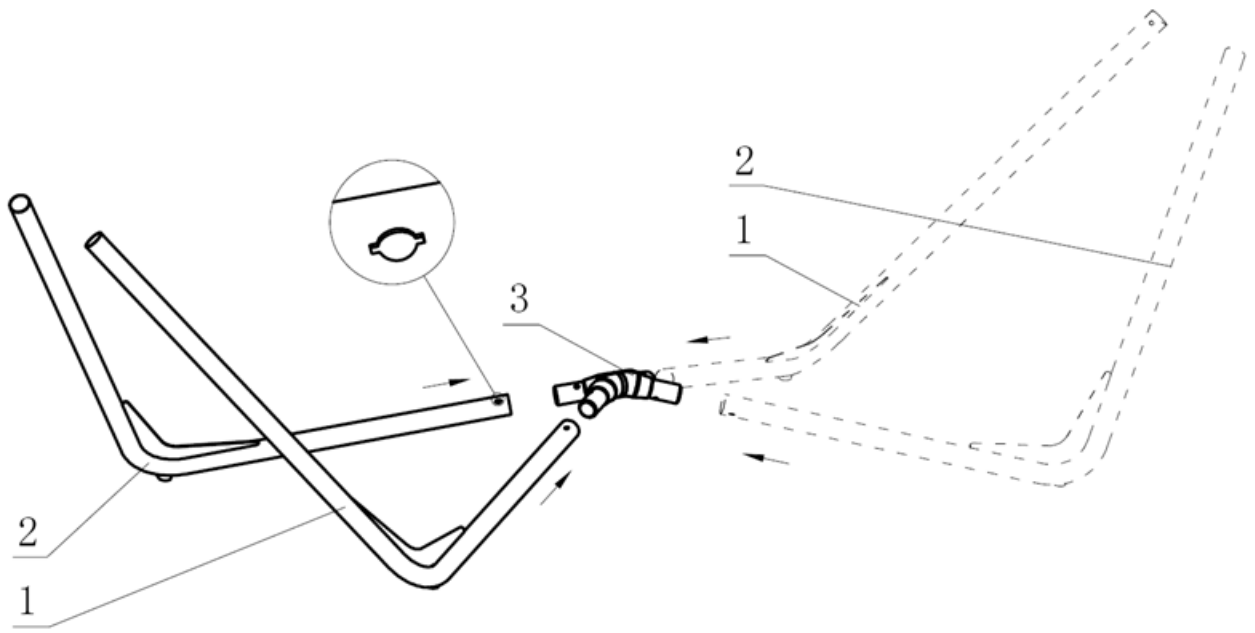

①

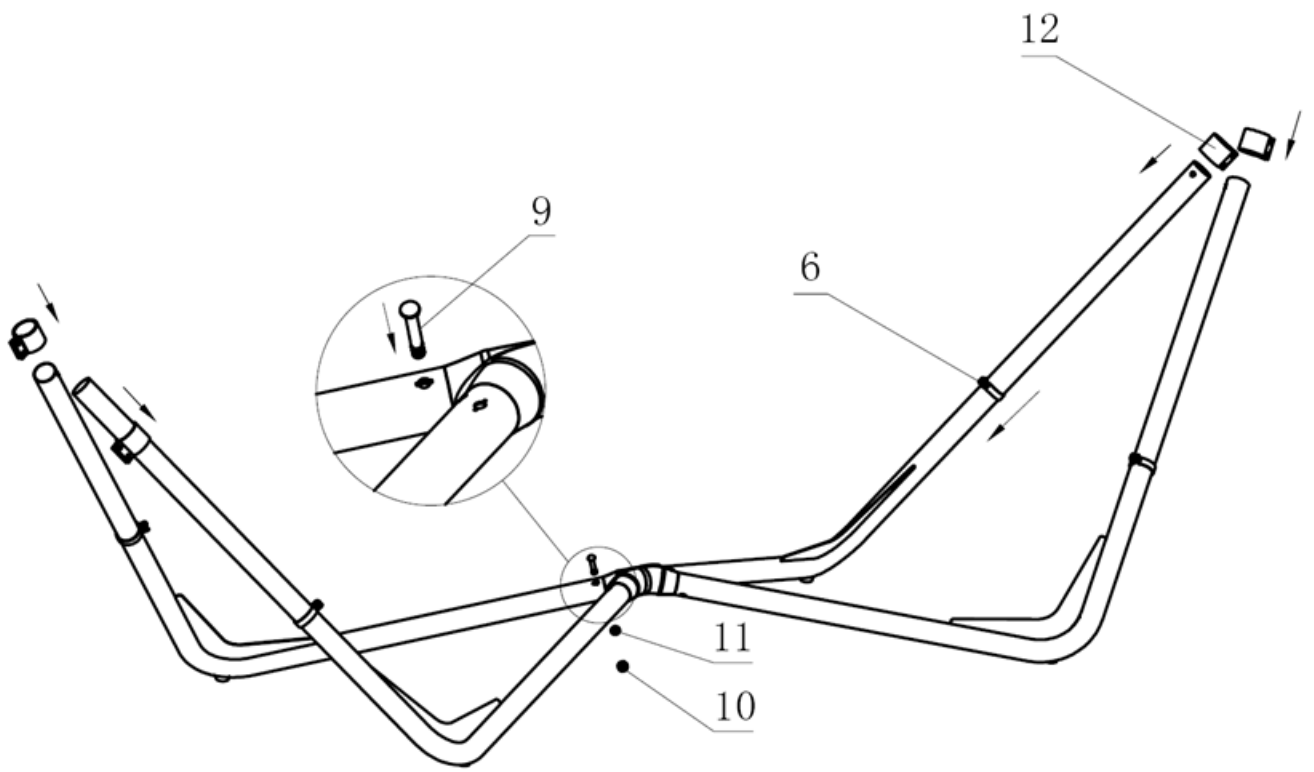

②

Um den Sonnenschutz zu installieren, benutzen Sie bitte Schraube Nr. 20. Möchten Sie die Hängematte ohne Sonnenschutz installieren, verwenden Sie bitte Schraube Nr.19

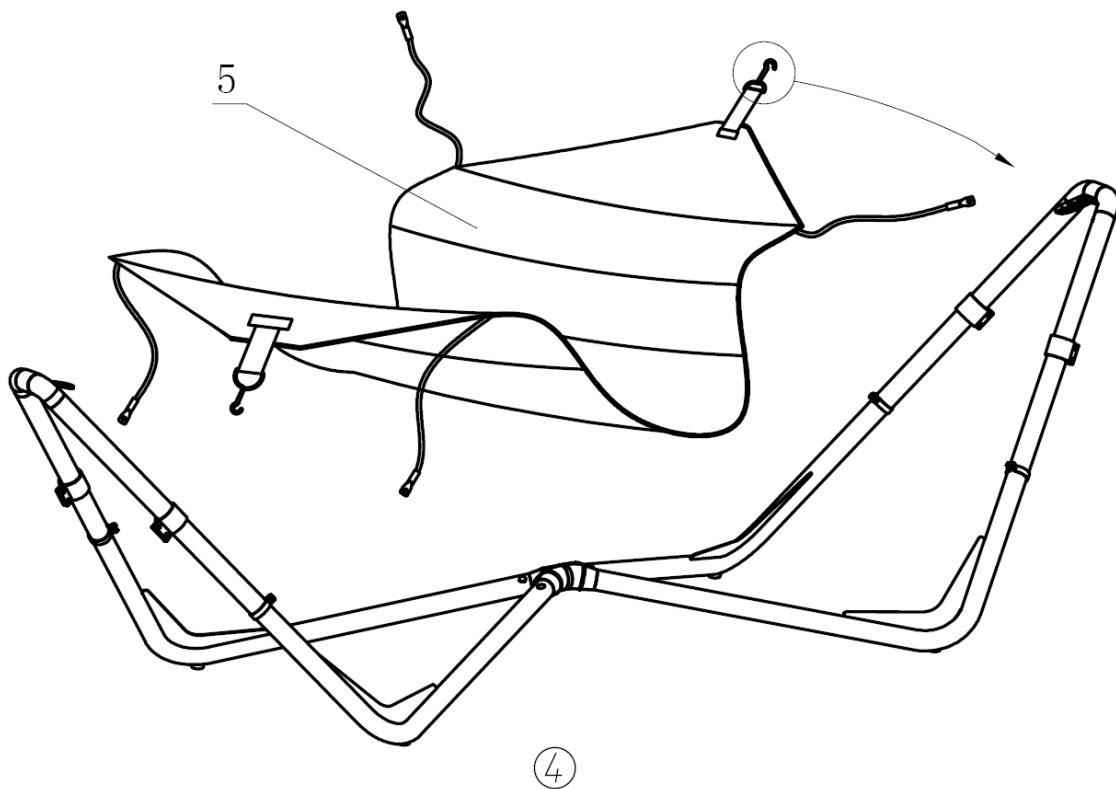
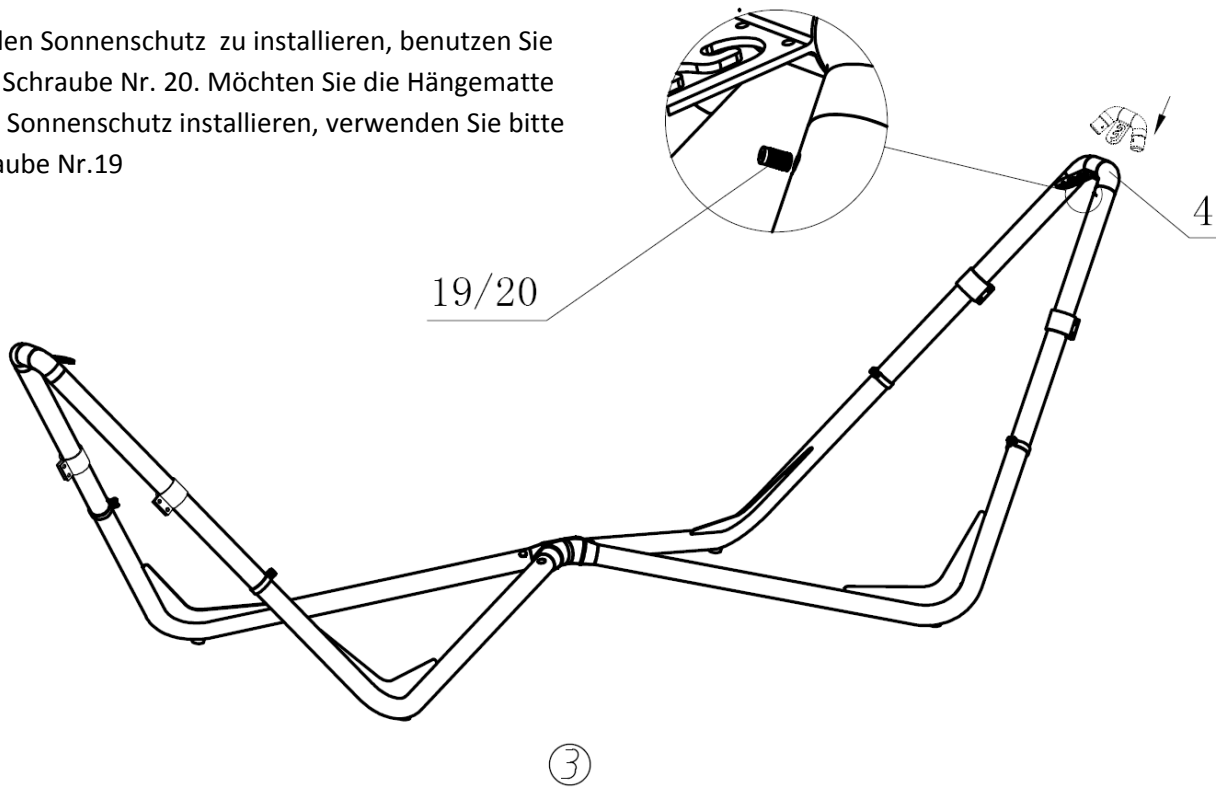

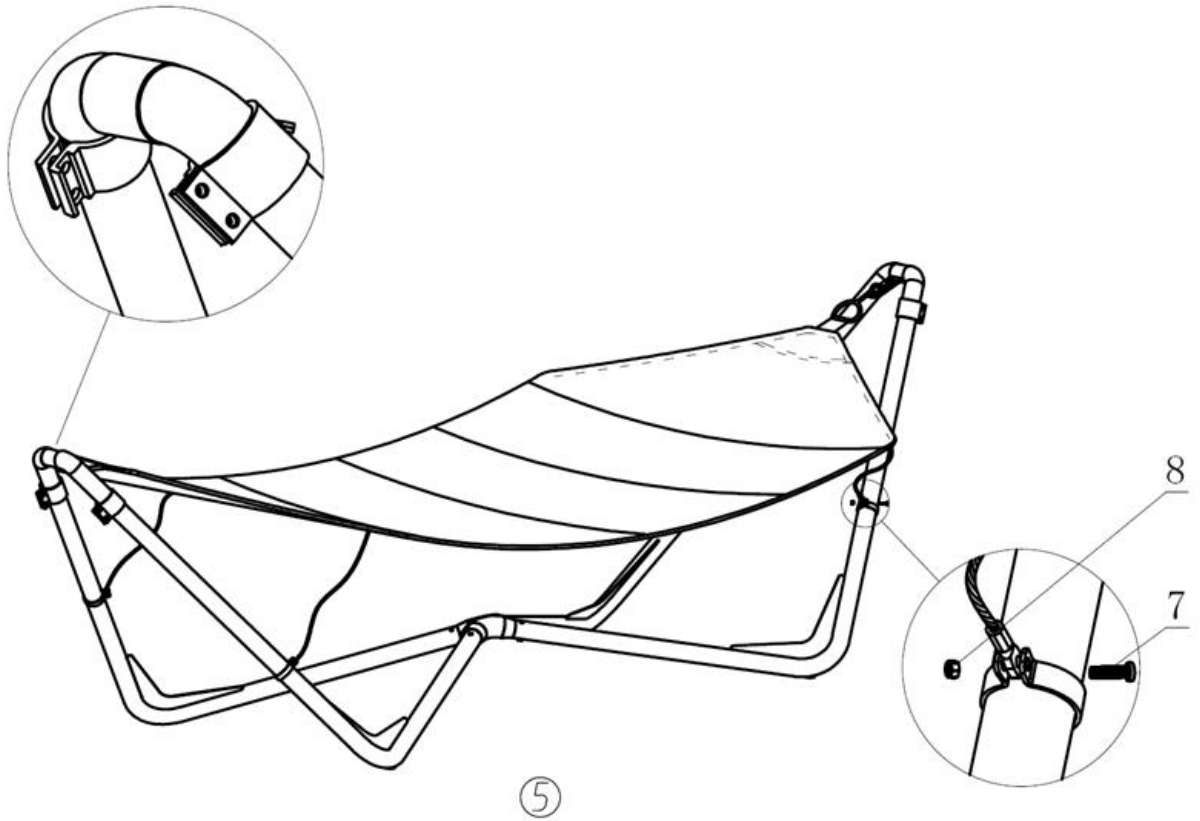

⑤

Ziehen Sie die vier Schrauben zunächst nicht fest an. Ziehen Sie sie erst fest an nachdem Sie das Doppelstirnrad in die höchste Position gebracht haben.

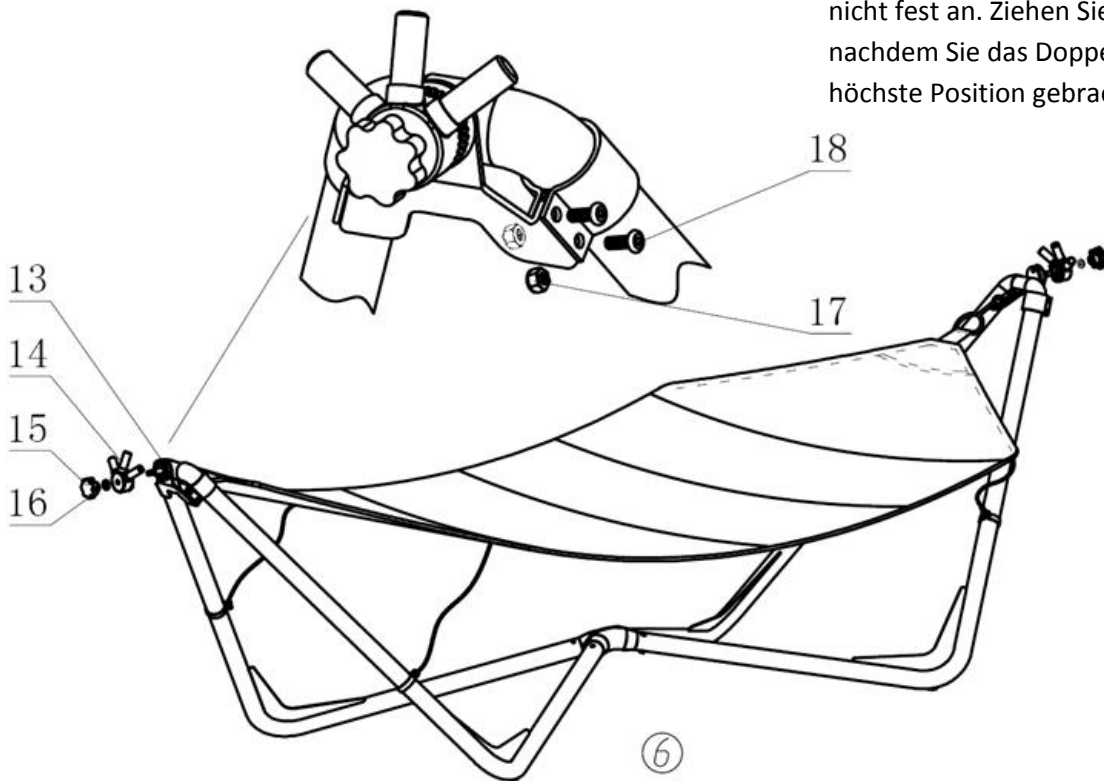

⑥

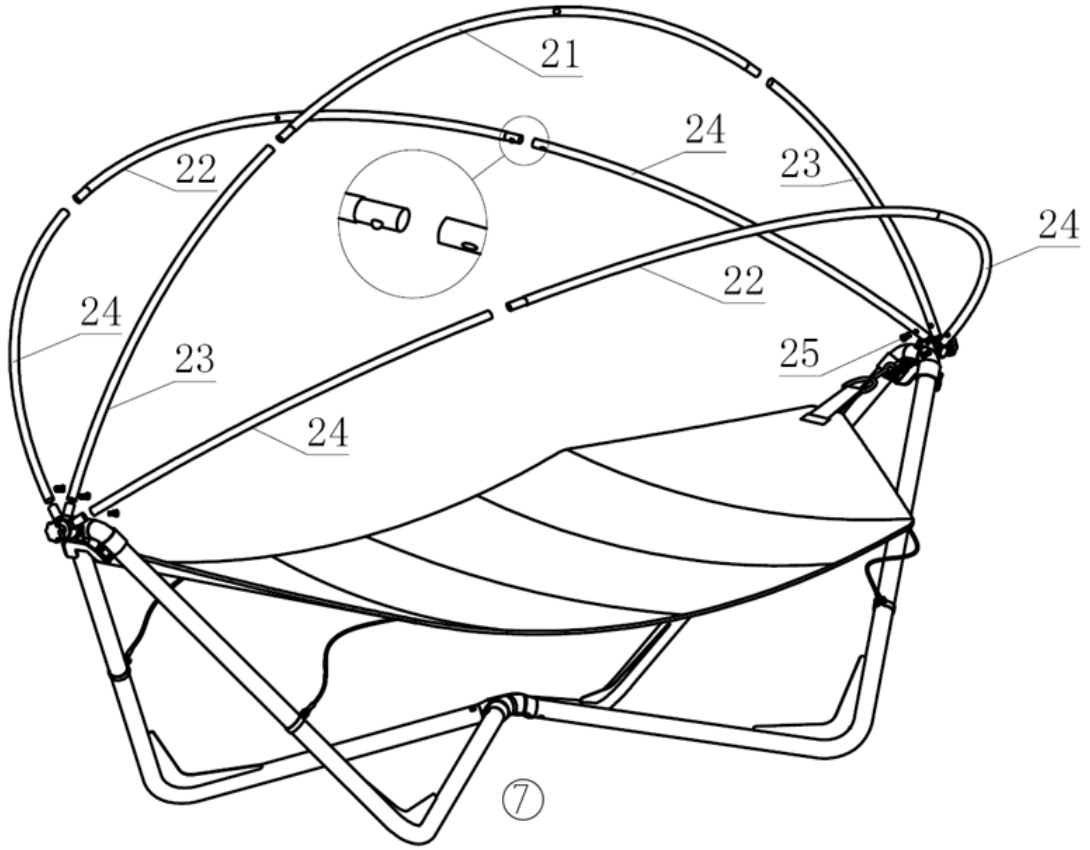

⑦

Befestigen Sie zur gleichen Zeit den Sonnenschutz während Sie die Verbindung Nr. 27 installieren.

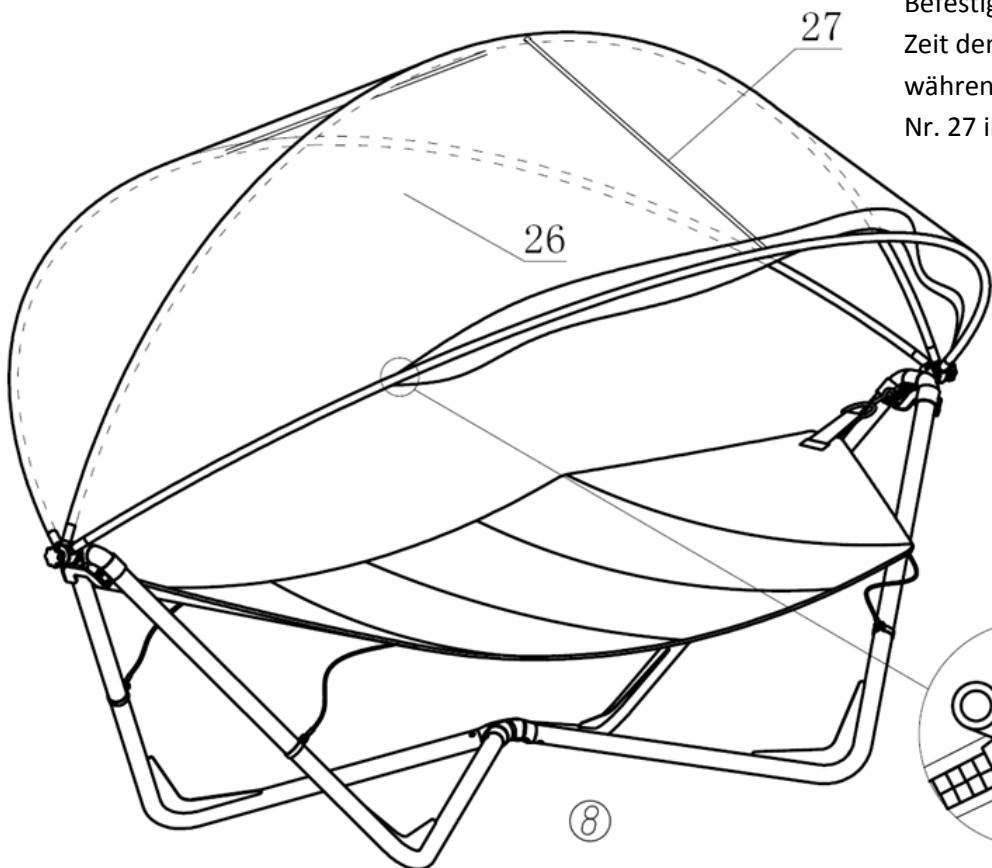

⑧

Schließen Sie bitte den Reißverschluss auf beiden Seiten

