







Montageanleitung

AMSTYLE®

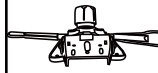
A brand of lifestyle products

SPM1.800

(1) Rollen  X5	(2) Fußkreuz 	(3) Gaslift 	(4) Mechanik 
(5) Armlehne 	(6) Sitzfläche 	(7) Rückenlehne 	

A

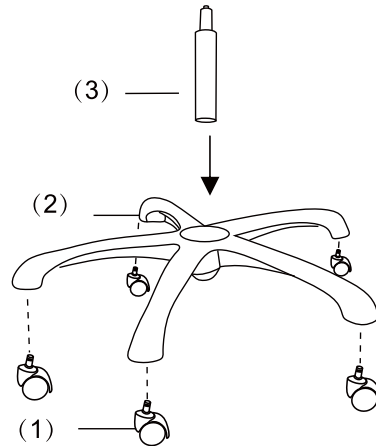



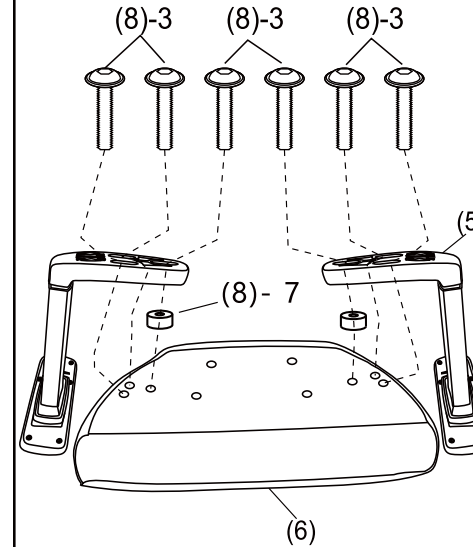



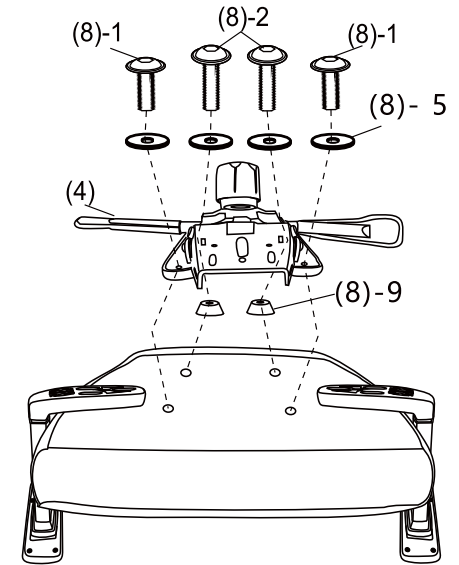



B



C



- (8)
1.  X2(M6*20mm)
 2.  X2(M6*25mm)
 3.  X6(6*40mm)
 4.  X3(M8*20mm)
 5.  X4(6*16mm)
 6.  X3(8*17mm)
 7.  X2(5mm)
 8.  X2(8mm)
 9.  M8
 10.  X1(5*25*65mm)

D

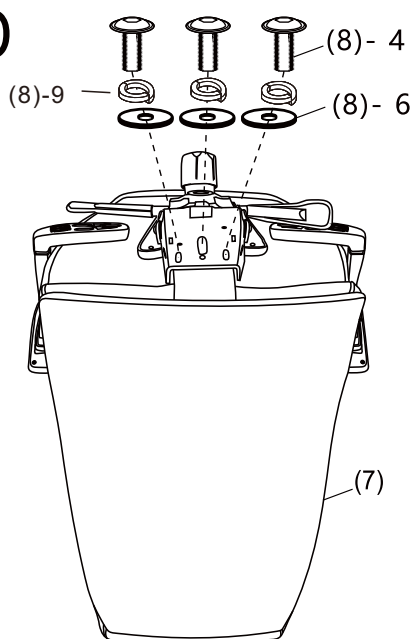

E

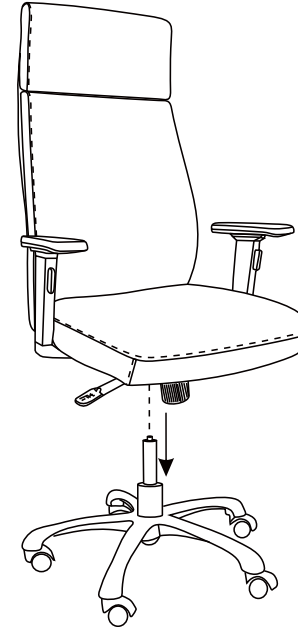

F

