

WL5.286

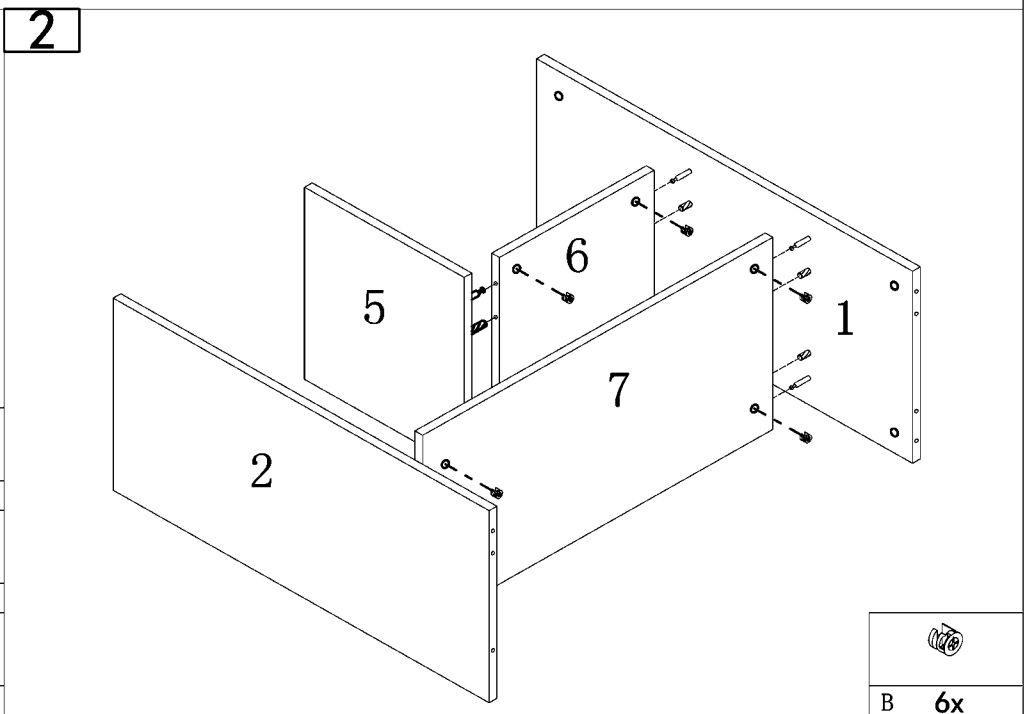

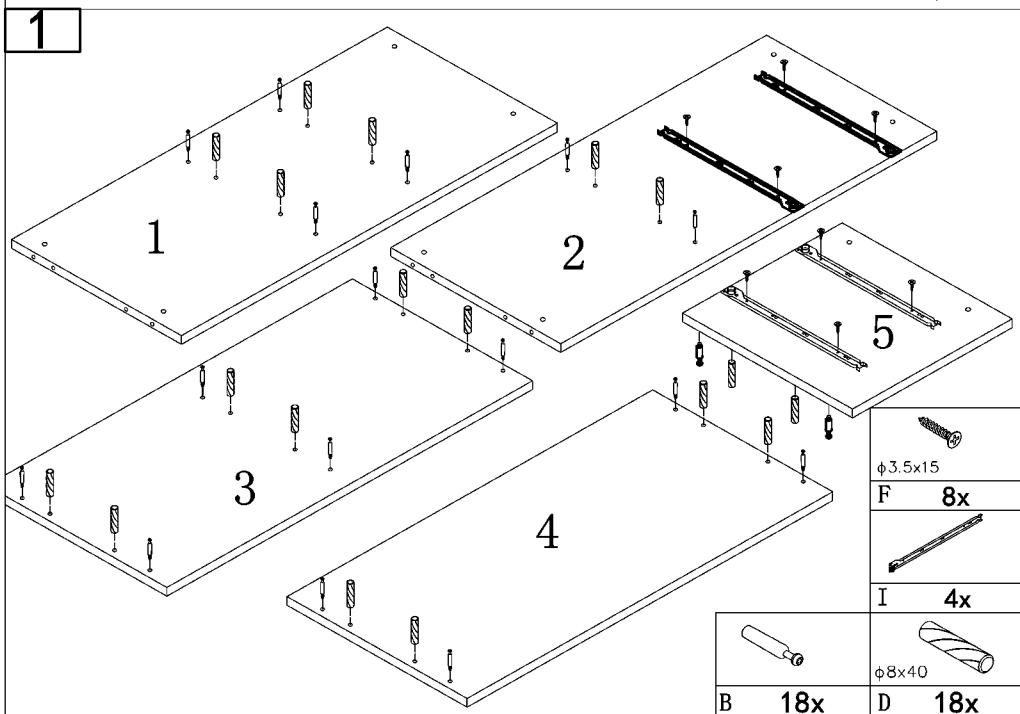

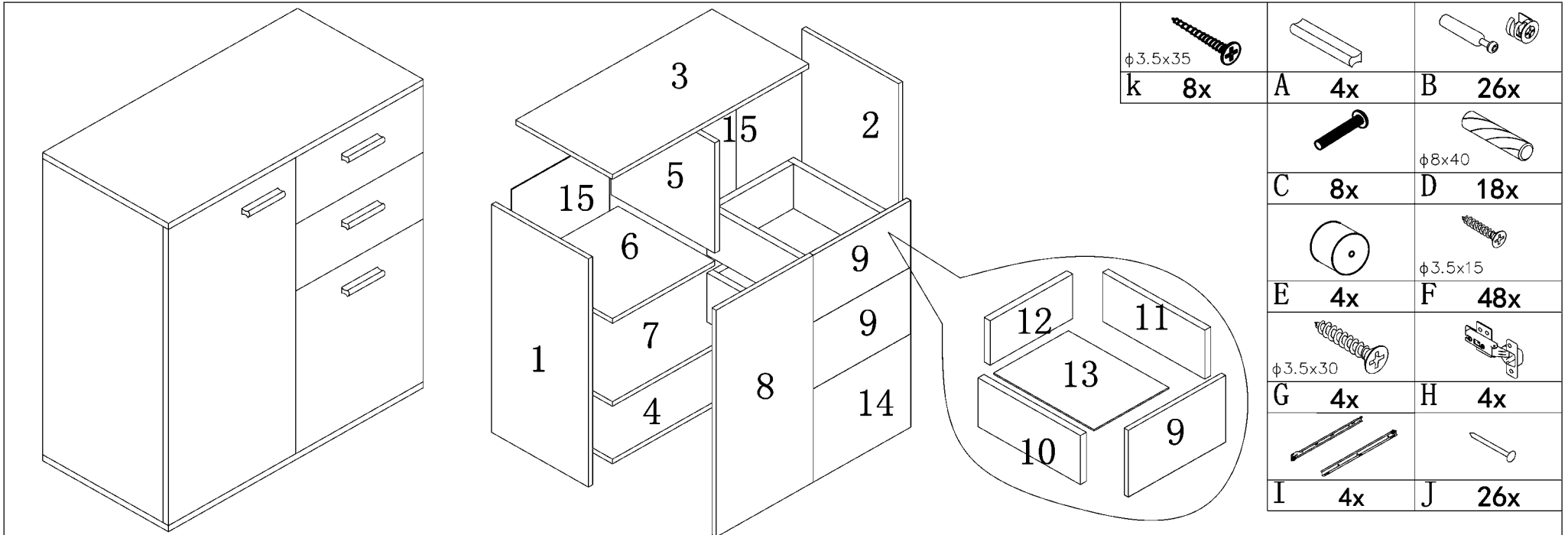
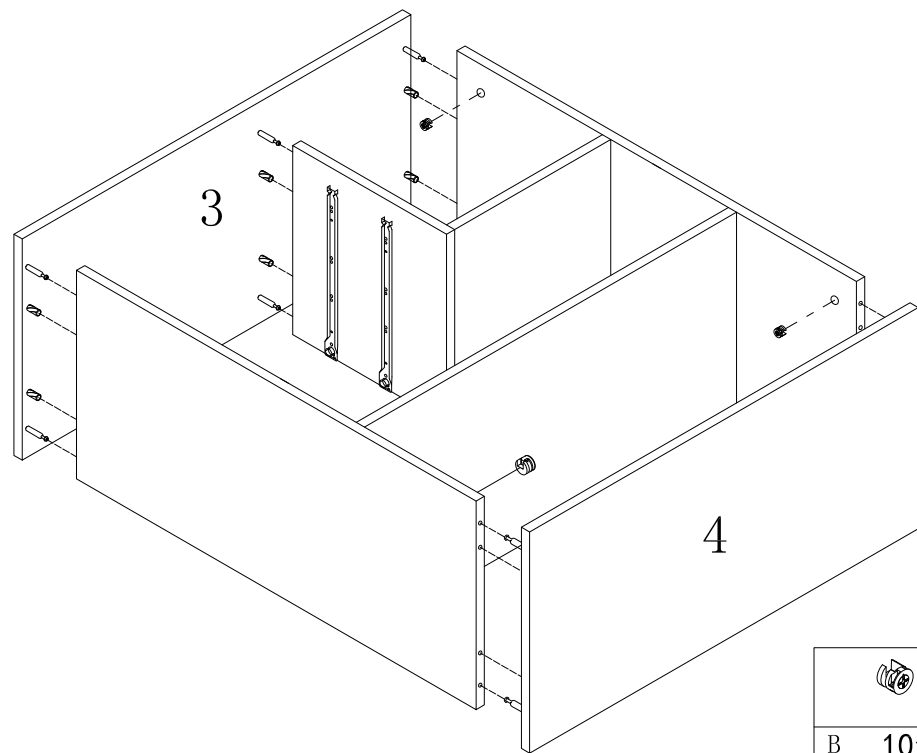

3

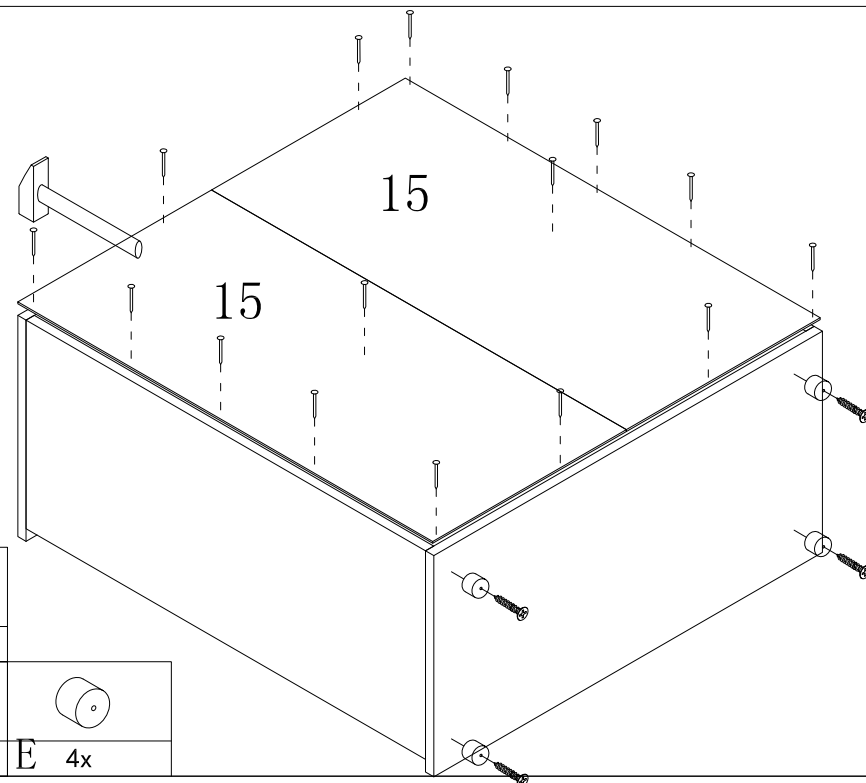



4



	$\phi 3.5 \times 30$		
G	4x		
	B	10x	
	J	26x	
	E	4x	

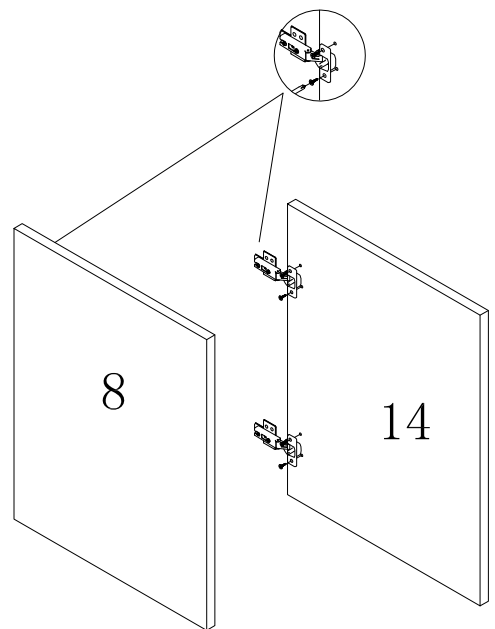





5

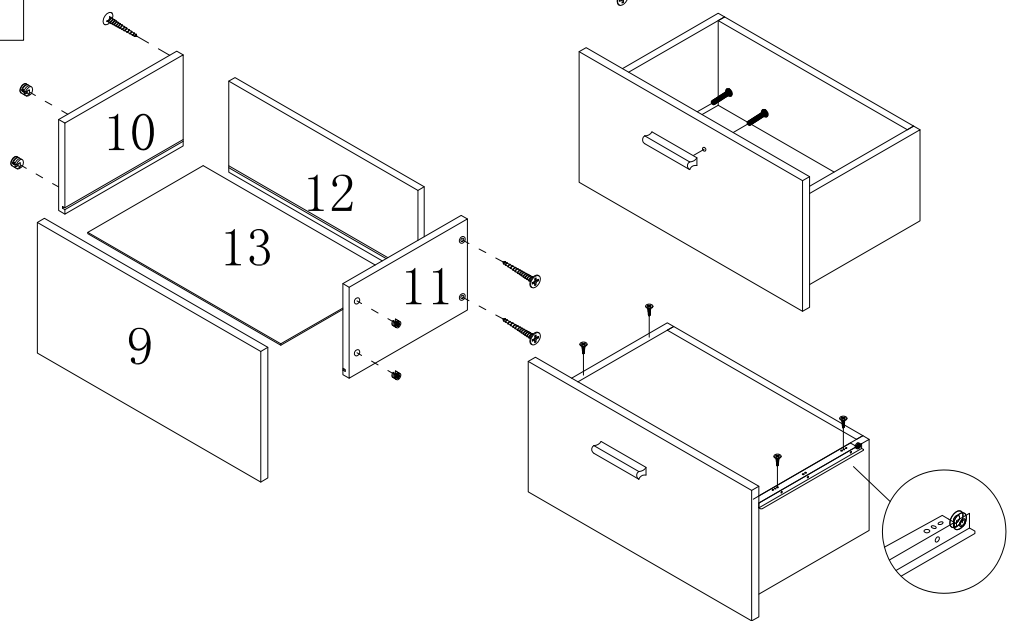

	$\phi 3.5 \times 15$	
F	8x	
	H 4x	





6

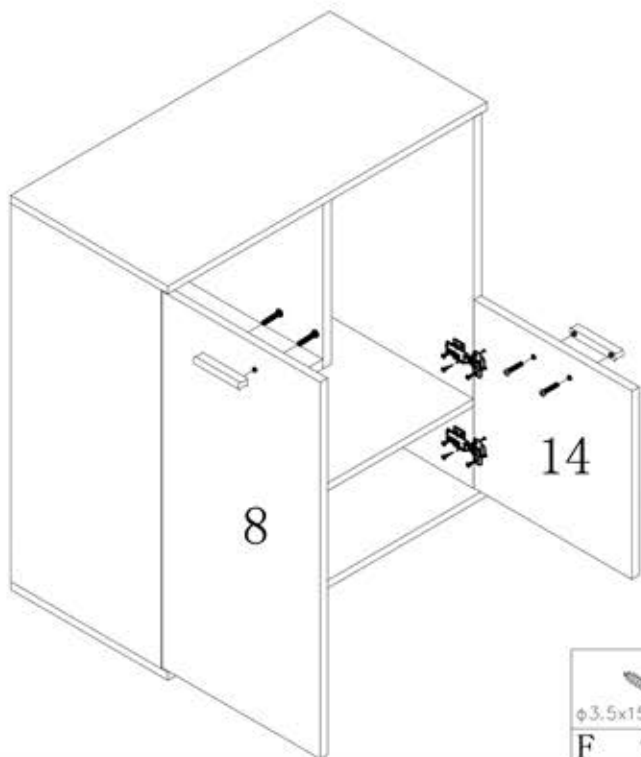

	A	2x		C	4x		I	2x		$\phi 3.5 \times 15$	F	8x		$\phi 3.5 \times 35$	K	8x		B	8x
---	----------	----	---	----------	----	---	----------	----	---	----------------------	----------	----	---	----------------------	----------	----	---	----------	----

7



- | | |
|--|--|
|  |  |
| F 16x | A 2x |
|  |  |
| C 4x | C 4x |
- $\phi 3.5 \times 15$

8

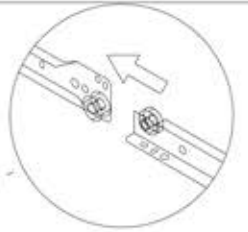
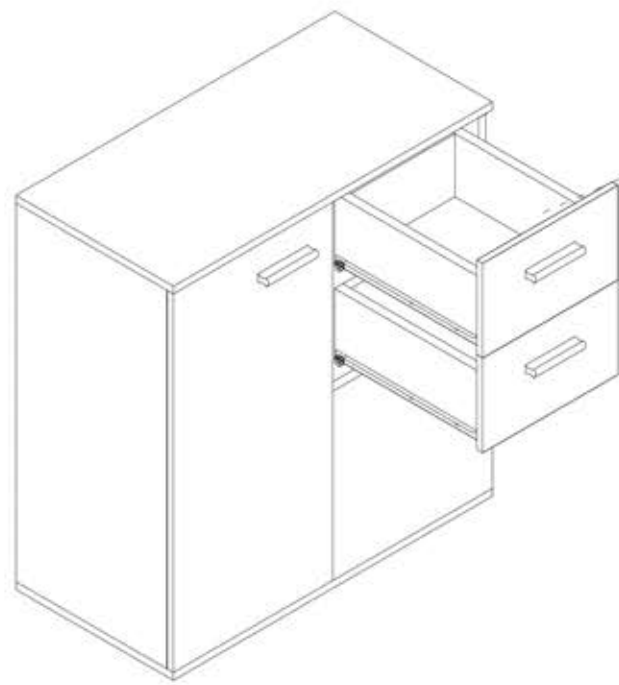

max.
40 kg