



Nanjing 100G Smart Tech Co.,Ltd



Manual

S900 Ebike Intelligent Display

Address: A27-130, NO.199 Mufu East Road, Gulou Dist. Nanjing, China

Tel: +86-13022528815

Website: www.100g.tech

1. Material&Dimension

1) Material

Caser and Cover and Press button: ABS,

LCD window: PMMA

2)Outside and mounting dimension(mm)

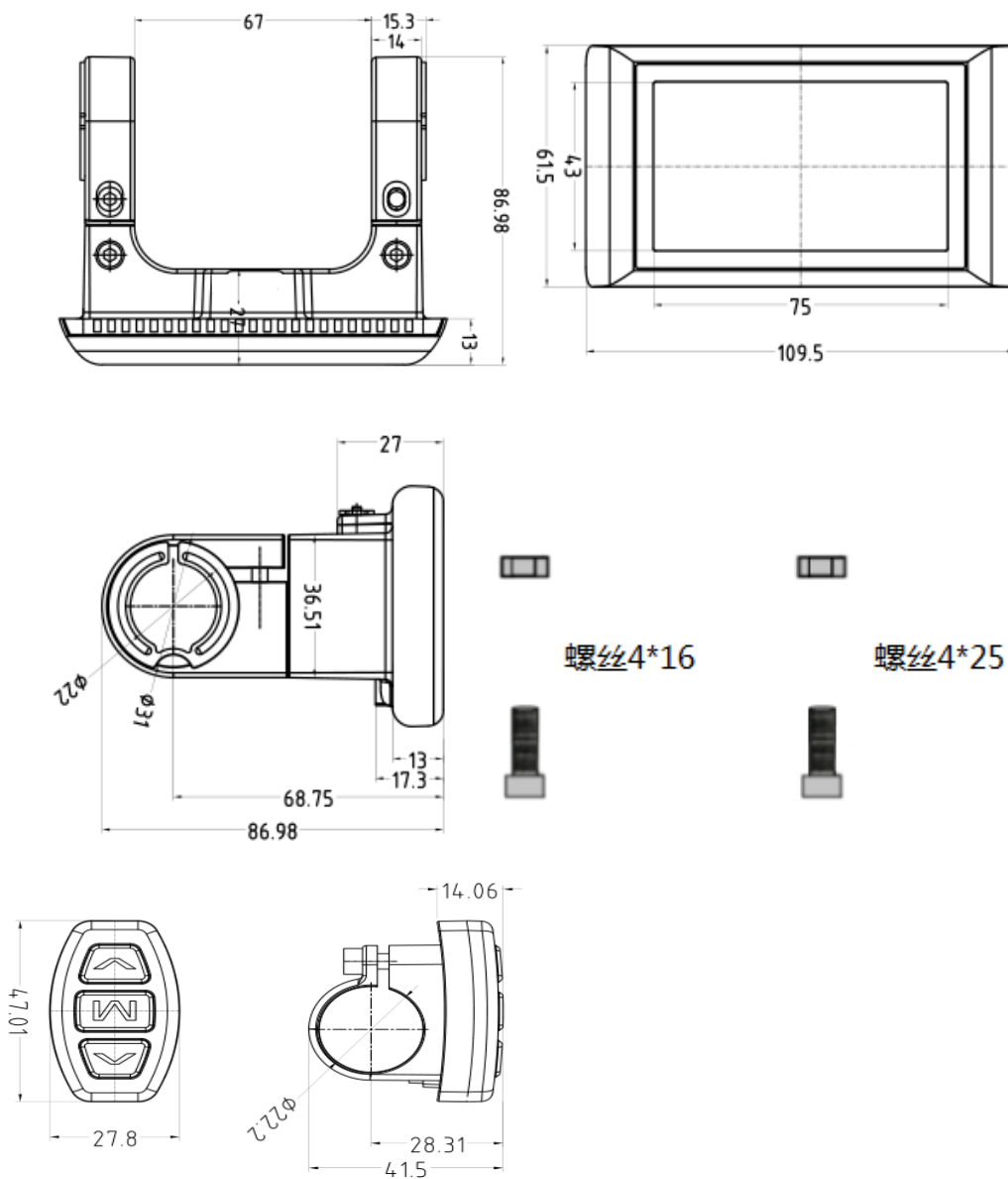

3) Connection diagram:

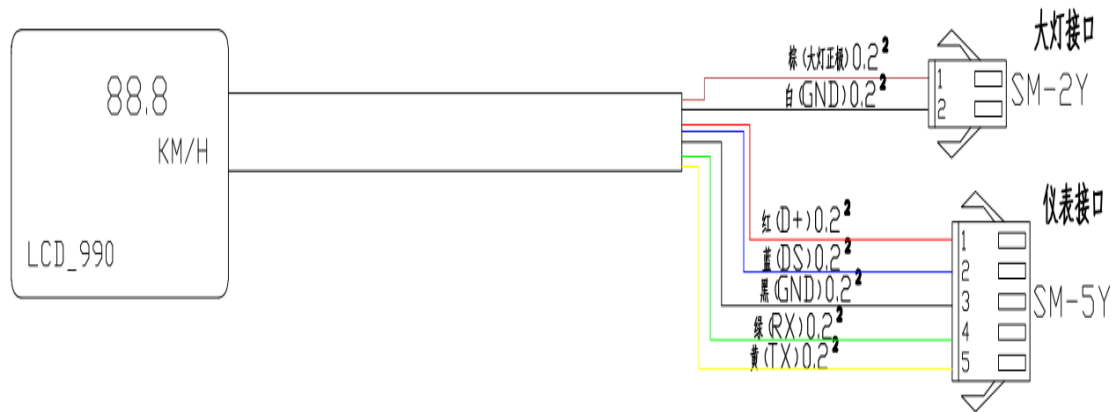

Wire definition:

Red: Power supply-VCC

Blue: Electronic lock-DS

Black: GND

Green: Data RXD

Yellow: Data TXD

BROWN: Head light(+) -DD

White: Head light(-)-GND

Remark: Connectors and Wire colors could be customized

5) Installation

- Install the display in the middle of handlebar, then adjust to suitable angle, install the press button to left side of handlebar.

- Power off the device, connect the device to controller.

- Power on

2. Overview of S900

1) UART protocol:

Equipped with independent press buttons

2) Speed:

Real-time SPEED, MAX SPEED, Average SPEED

3) kmh/mile:

Kmh/MPH according to habit

4) Battery level:

Indicates the battery level in real time

5) Back light control:

Press  button for 3 seconds to power on/off

6) Back light adjustment:

3-level adjustment

7) Assist level:

From 1 to 3, press button to change assist level.

8) Distance:

ODO/Trip/Driving duration

9) Error code:

Please refer to appendix table 1 for definition

10) 6km mode:

In this mode, it will display  on the screen.

11) Parameter setting:

Set parameters, such as: wheel size, speed limit etc

3. Presentation of screen

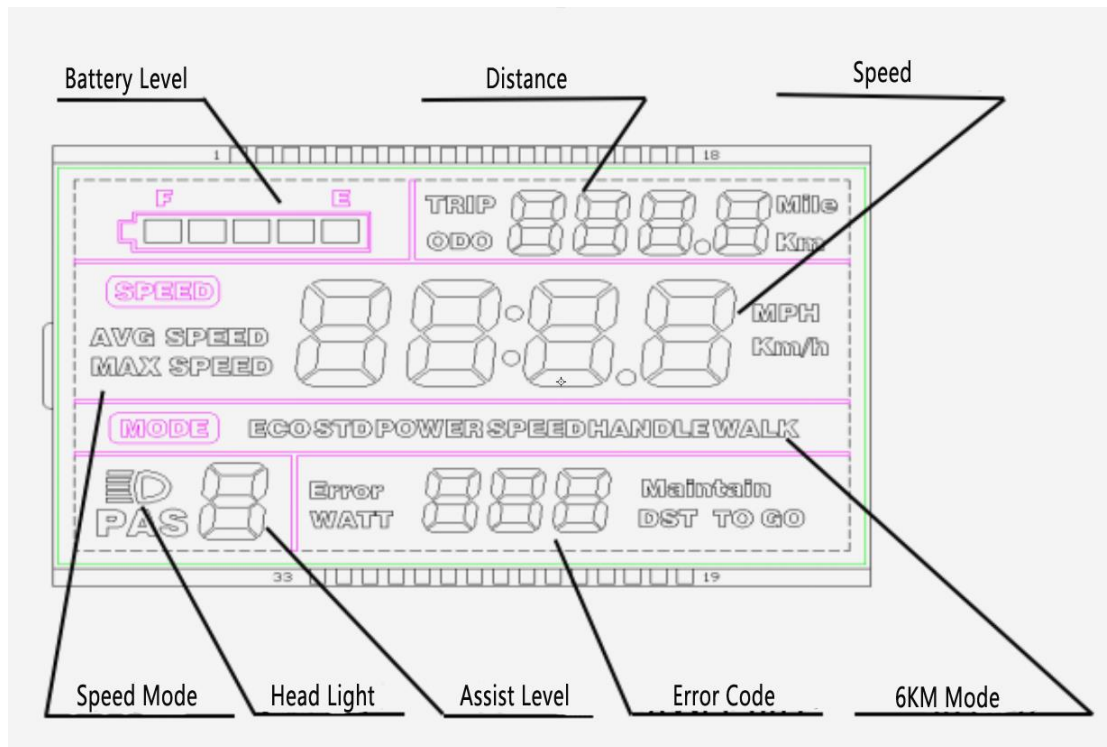

- 1) Battery level: 5 levels, voltage interval could be customized
- 2) Speed: Average SPEED/MAX SPEED/Real-time SPEED
- 3) Speed unit: Km/h/MPH
- 4) 6km mode: 6km mode Display .
- 5) Assist level: actual assist level 1~3.
- 6) Back light icon: indicates when back light are on.
- 7) Distance: Trip/ODO.
- 8) Error code: "ERR" and code when there is error



4. Press button definition

S900 uses independent press button, in total three buttons:



5. Operation instructions

1) Power ON/OFF

When the power is off, Long press  (Power) during 3 seconds , screen will display all contents and start to normal working mode, and controller will be turned on When the power is on, Long press  (Power) during 3 seconds, screen will be powered off, and controller will be turned off . If no any operation both on bike and display during 10 minutes (time could be set), the display will turn off automatically , in this case, no power consumption for both display and controller.

2) Different Speed display:



Long press  and  to switch different speed information, Real time speed (SPEED) → Max speed (MAX SPEED) → Average speed (AVGSPEED)

Figure 2

3)ODO/TRIP/ Driving T Real time speed

Short press  to switch ODO/TRIP/ Driving Time/Error Code Trip(Single trip distance)→ODO(Accumulated distance)→ TM(Driving Time) →ERR(Error Code) 。

4)Assist level

Short press  or  to change assist level, default value is



level 1

5) Back light control





Long press  for 3 seconds turn on/off the back light.



6) 6km mode

When the bike is stopped, long press , will enter 6km/h mode, the speed will be 4.5~7.5km/h according to different road



conditions, “” will show up on screen, long press  again or short press , will quit 6km/h mode. Long press or short press could be customized by clients.

6. Parameter setting

When the display is powered on, long press  and , will enter parameter setting mode, in this mode, can change parameter values, long press again  and  will quit parameter setting mode or no operation during 10s will also quit this mode.

In parameter setting mode, short press  /  will change parameter value, short press  will save current value and switch to next parameter.

1) P01-back light lightness:



short press  /  will switch from 1 to 3, Level 3 is

lightest. Level 2 is default value.



2) P02-kmh/MPH:

Short press  /  to Switch kmh/MPH.

3) P03-Working voltage:

short press  /  to switch 36V,48V, Default value is 36V.

4) P04-Auto shutdown time:

short press  /  to switch from 0 to 60, it is the time(in minutes) to shut down the screen automatically if no operation 0 means never shut down, Default value is 10 minutes

5) P05-Number of Assist levels:



Short press  /  to change level 0->1->2.

0: 3 assist levels

1: 5 assist levels

2: 9 assist levels



6) P06-Wheel size selection:

short press  /  to switch wheel size, in inch, step: 0.1 inch



7) P07-Number of magnets for speed sensor:

short press  /  to switch from 1 to 100.

8) P08-speed limit:

short press  /  to set the speed limit from 0 to 100Km/h,
100 means no limit.

9) P09-Non-zero speed start:

short press  /  to switch from 0 to 1. 0: zero speed
start,1:non-zero speed start.

10) P10-Driving mode selection:

short press  /  to switch from 0->1->2.

0: Assist mode (throttle does not work, only assist);

1: Electrical driving mode(only throttle works, assist does not work) ;

2: Both assist and Electrical driving mode(Not available if in zero speed
start and electrical driving mode);



11) P11-assist sensitivity setting:

short press  /  to switch from 2 to 20.

12) P12-assist starting power setting:

short press  /  to switch from 0 to 5.

13) P13-Assist magnetic disc types

short press  /  to switch from 5->8->12 , different numbers of magnets. 100G system Default is 0, PAS sensor is 12.

14) P14-Current limit for the controller:

short press  /  to switch from 1 to 20A

15) P15-low voltage protection for controller



16) P16-Reset ODO distance:

long press  during 5 seconds

17) P17-Reset all parameters:

long press  5 seconds , when it displays “SSSS” , all parameters reset to default values(except for the ODO distance)

18) P18-Max RPM of the motor:

short press  /  to switch from 120 to 1000 RPM

19) P19-PAS Magnet calibration for the controller:

short press  /  to switch from 0 to 1

20) P20-Number of magnets for freewheel speed sensor:

short press  /  to switch from 0 to 20

7. Specifications

1) Power supply: 24V,36V,48V

2) Rated current: 10mA

3) Max current: 3

4) Leakage current after power off: $<1\mu\text{A}$

5) Current supply to controller: 50mA

6) Working Temperature: $-18\sim 65^{\circ}\text{C}$

7) Storage temperature: $-30\sim 80^{\circ}\text{C}$

8. Error code definition

When an error appears, S900 will notice users by different codes, please refer to table 1 for different codes:

100G Controller Error Manual					
Type 1 Error			Type 2 Error		
Error Code	LED Flashing	Description	Error Code	LED Flashing	Description
0121	1-2-1	Hall A Error	0211	2-1-1	Overvoltage
0122	1-2-2	Hall B Error	0212	2-1-2	Undervoltage
0123	1-2-3	Hall C Error	0221	2-2-1	Throttle Protected
0124	1-2-4	Motor Connection Fault	0222	2-2-2	Brake
0131	1-3-1	Phase A Disconnected	0223	2-2-3	Leave Seat Protect
0132	1-3-2	Phase B Disconnected	0224	2-2-4	Stall
0133	1-3-3	Phase C Disconnected	0231	2-3-1	Controller Temperature Orange Alert
0141	1-4-1	Phase A Sampling Error	0232	2-3-2	Controller Temperature Red Alert
0142	1-4-2	Phase B Sampling Error	0241	2-4-1	Overspeed
0143	1-4-3	Phase C Sampling Error	0242	2-4-2	Locked
0151	1-5-1	Phase A Overcurrent			
0152	1-5-2	Phase B Overcurrent			
0153	1-5-3	Phase C Overcurrent			

Table 1

9. Notices

Power on and power off must keep an interval of at least 3 seconds,

please don't press "" button frequently when it is powered off.

When the temperature is under -10°C , the screen will be a little darker than normal, when the temperature increases, the screen can go back to normal

10. FAQ

1) Q: Why I can not power off?

A: Please check connection between display and controller.

2) Q: What can I do if an error code displays?

A: Find a nearest shop to get repair

11. Warranty

1 year of warranty for quality issue except frame is broken.

12. Version

This is a universal manual for S900. It could be customized by each client. Please confirm all details before purchasing.