

INTERACTIVE DARTS

What's in the box?

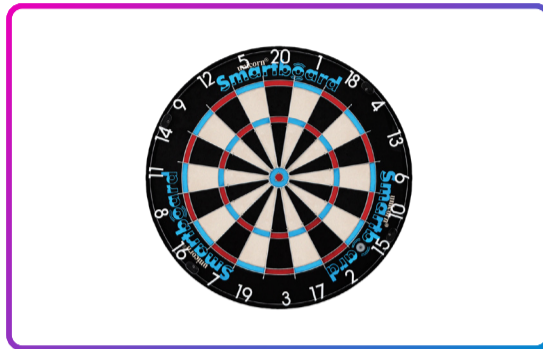

SMARTS Console



Unicorn Smartboard
(commercial - white)



All Cabling



Unicorn Darts

INTERACTIVE DARTS

Venue requirements - SPACE



This is only one example,
other configurations are
possible.

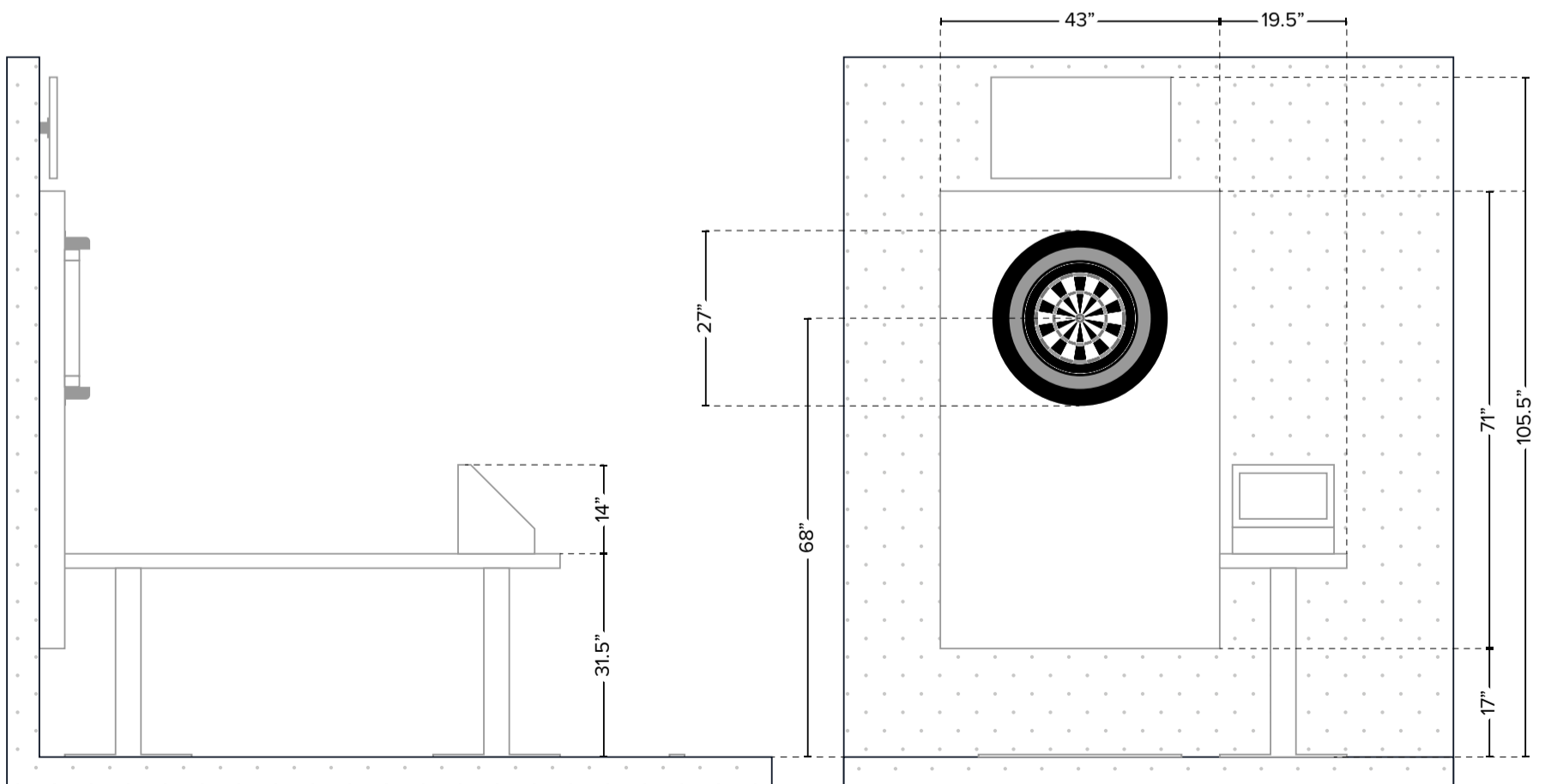
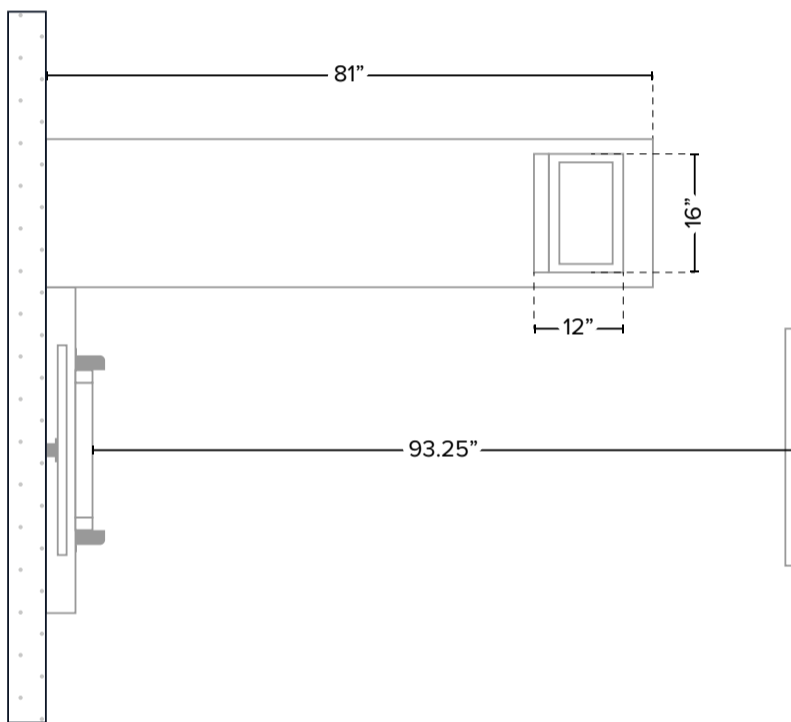

INTERACTIVE DARTS

Venue requirements - POWER & DATA



4 x Power
1 x Data (RJ45) - open access

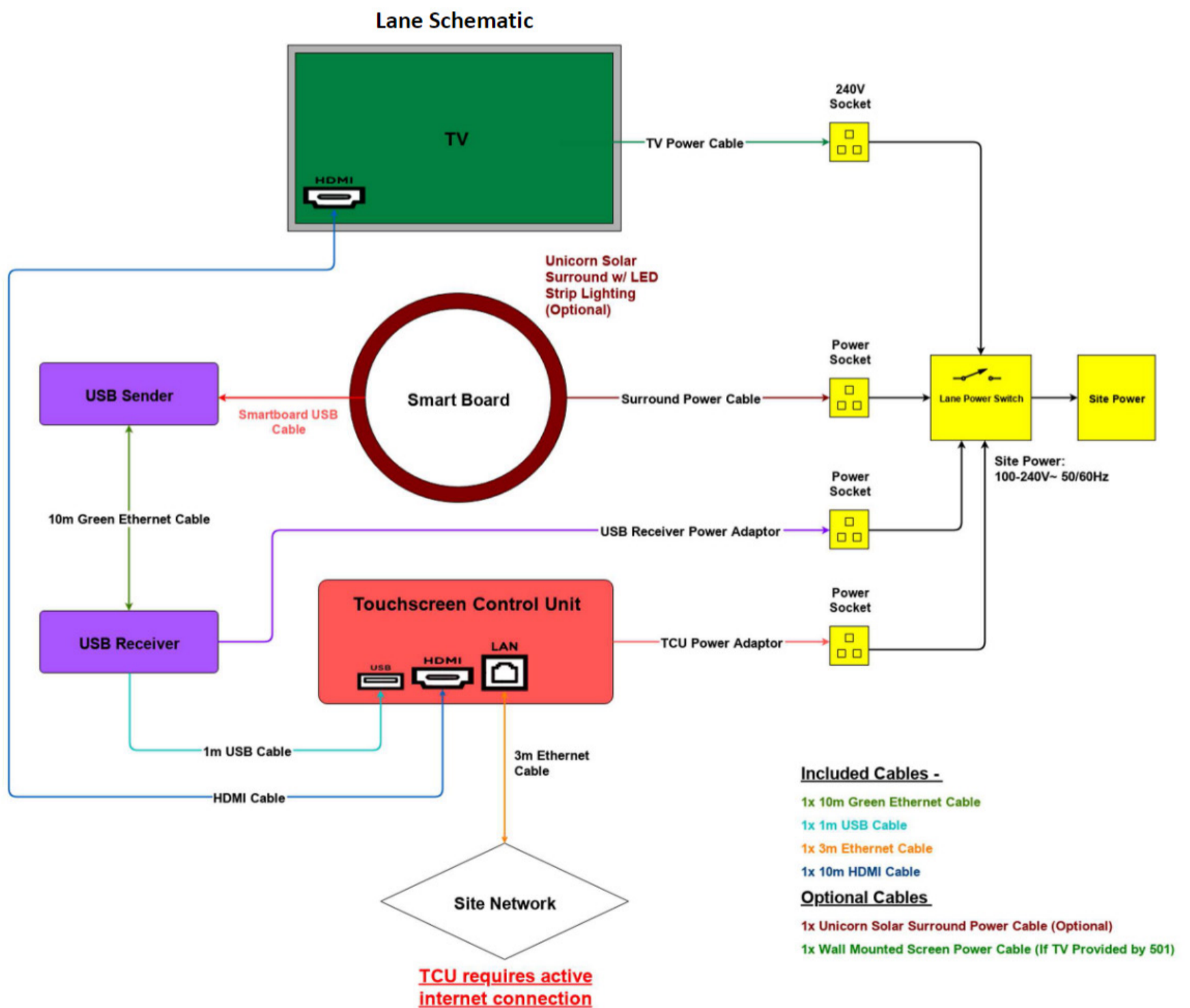

INTERACTIVE DARTS

Venue requirements - OTHER EQUIPMENT

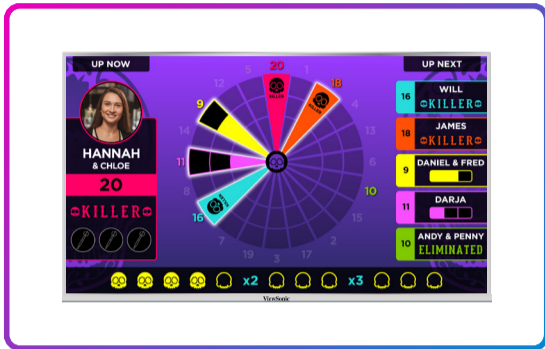

TV Screen 32"-50"



TV Bracket



Screen Protector



Dartboard Lighting

INTERACTIVE DARTS

Venue requirements - FIT OUT



SMARTS Console housing

Examples:



INTERACTIVE DARTS

Venue requirements - FIT OUT

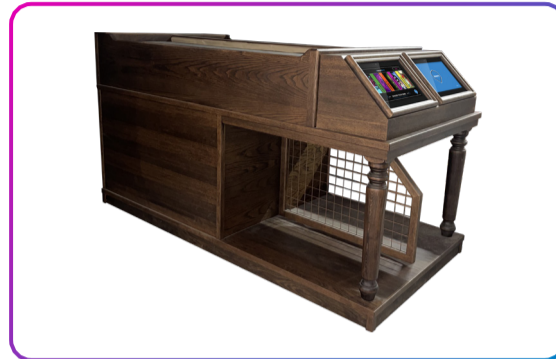

Lane divider

Examples:

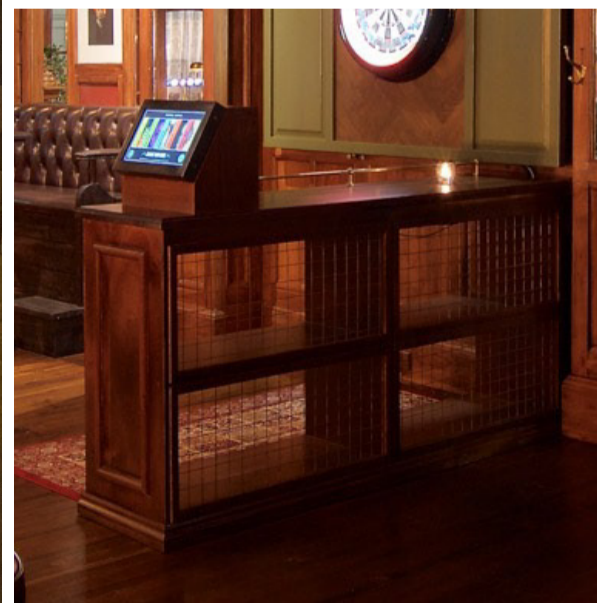
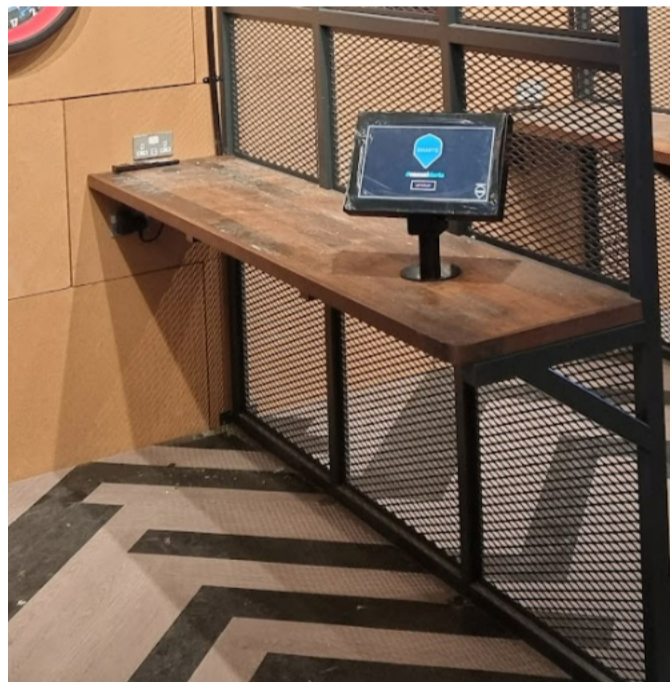

INTERACTIVE DARTS

Venue requirements - FIT OUT

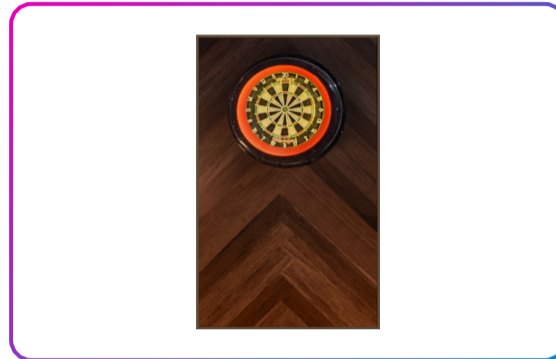

Wall Panel

Examples:

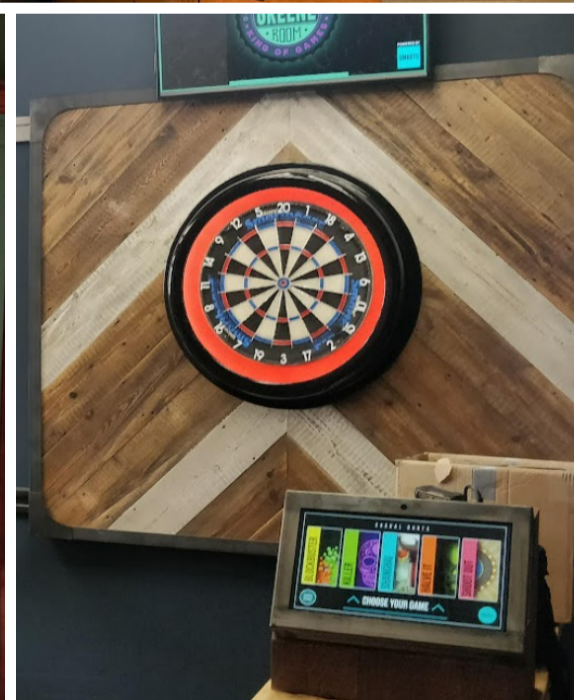
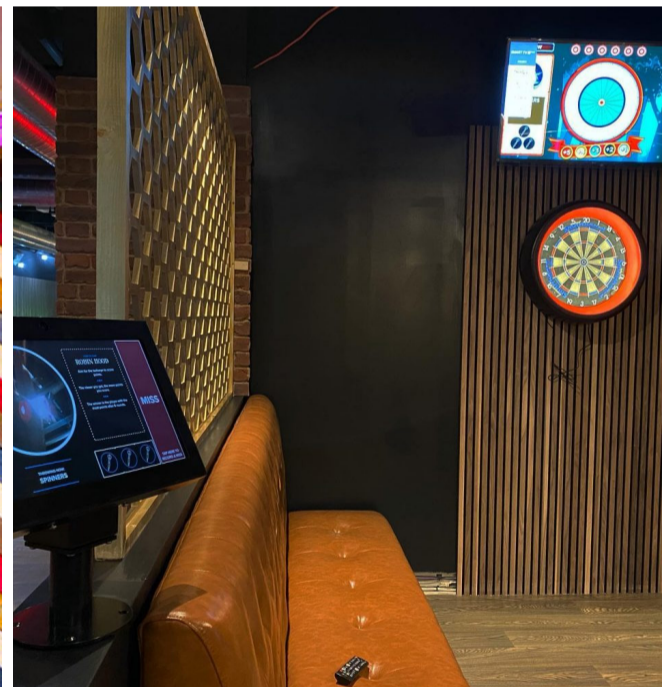
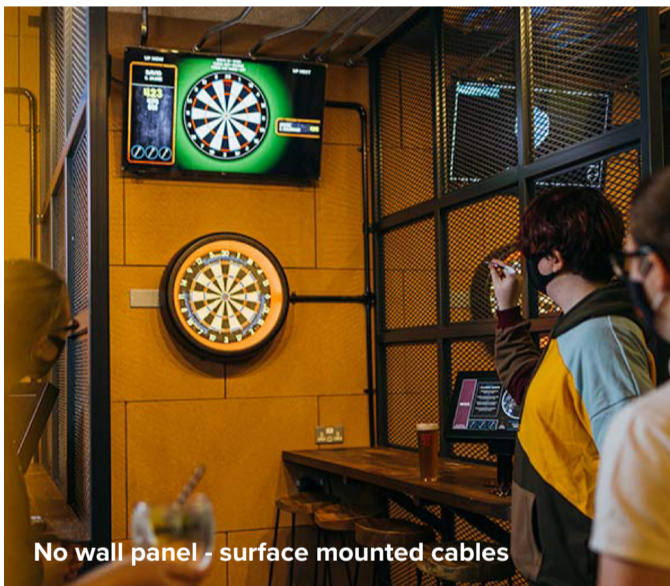

INTERACTIVE DARTS

Installations

