

1

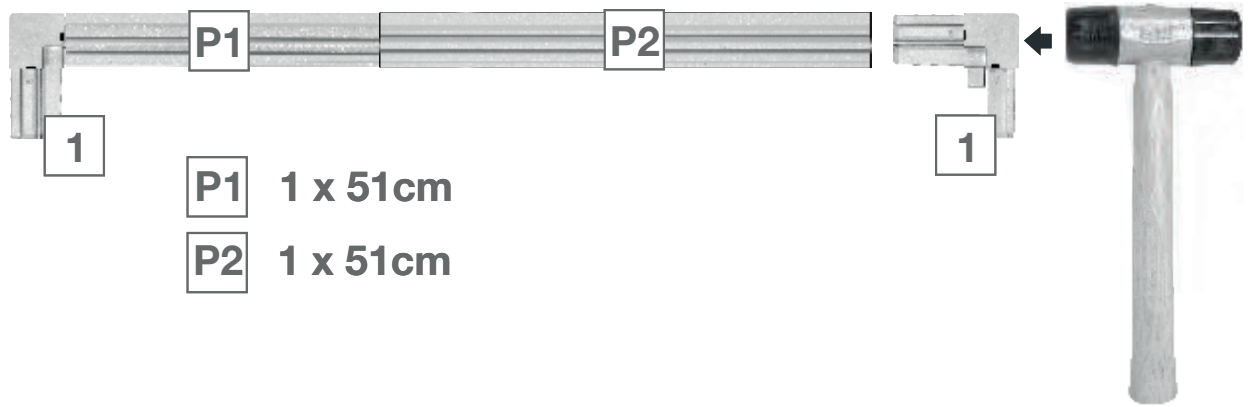

2

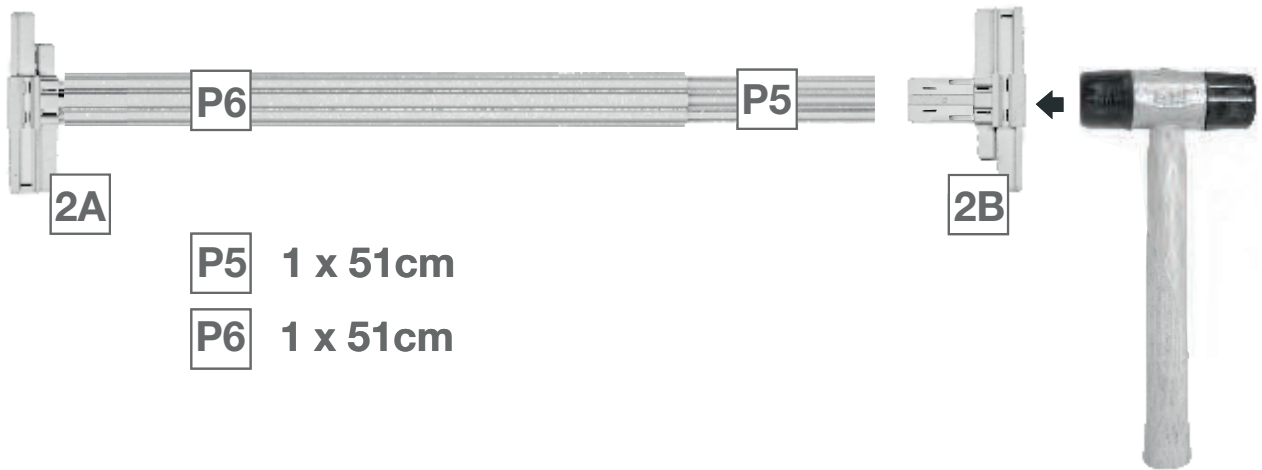

3

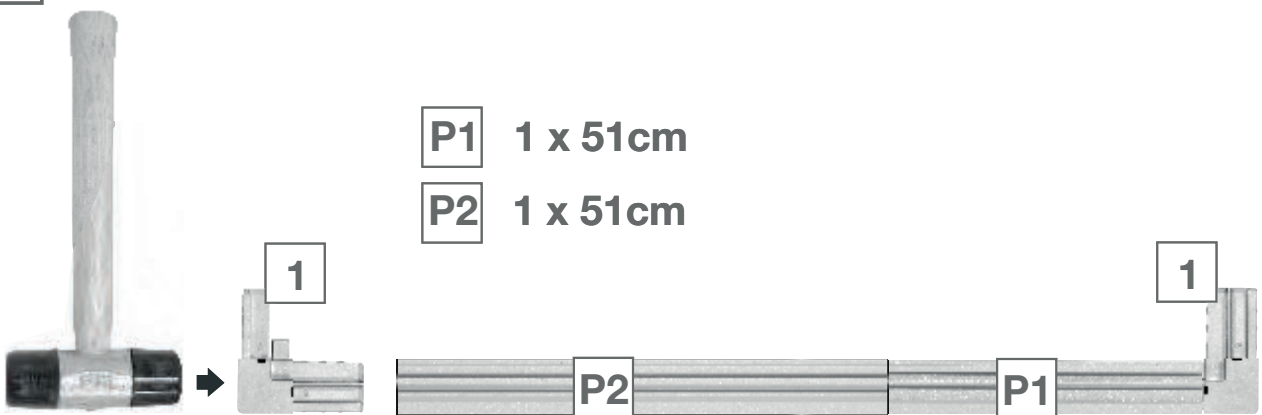

4

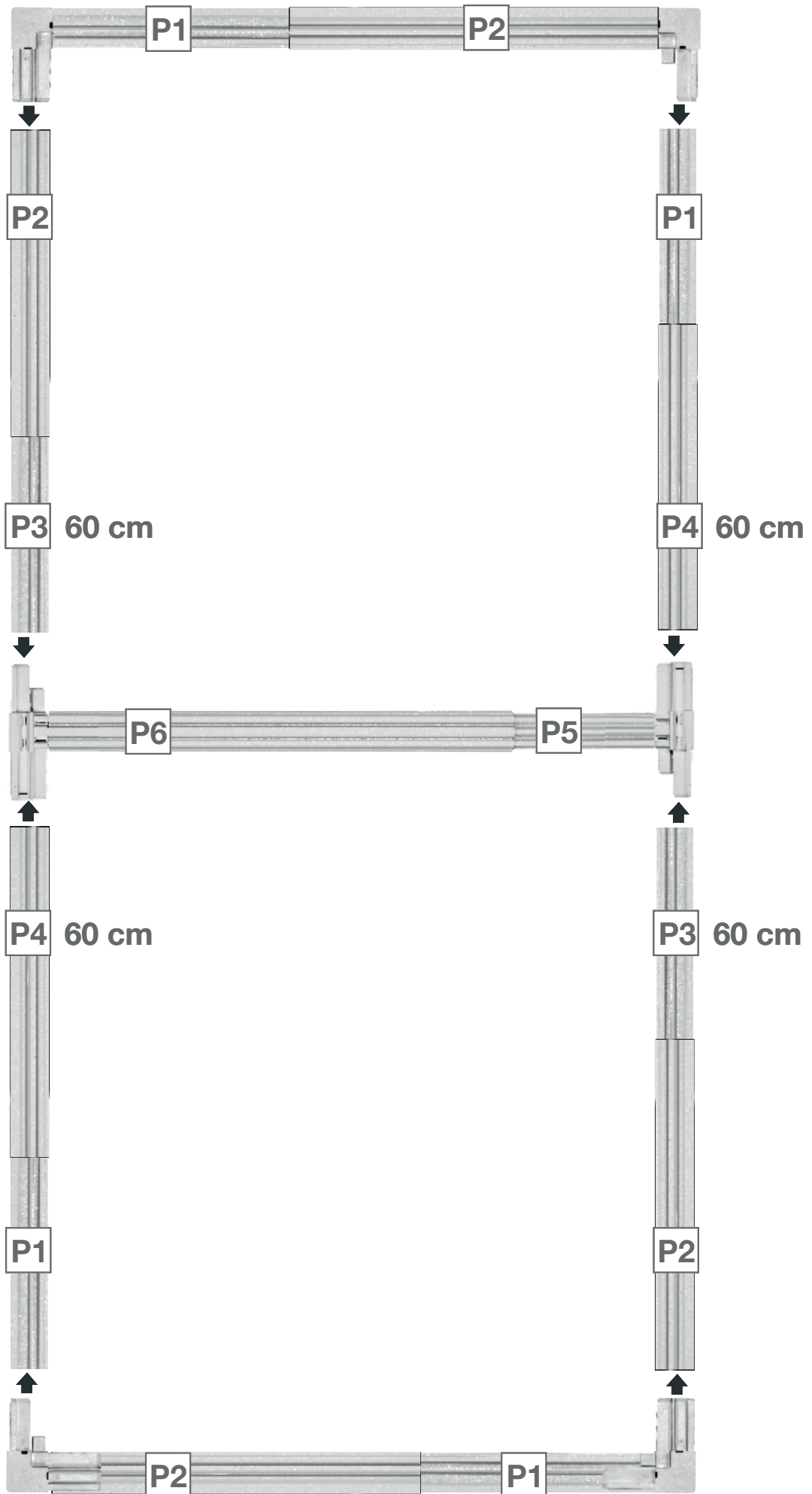

5

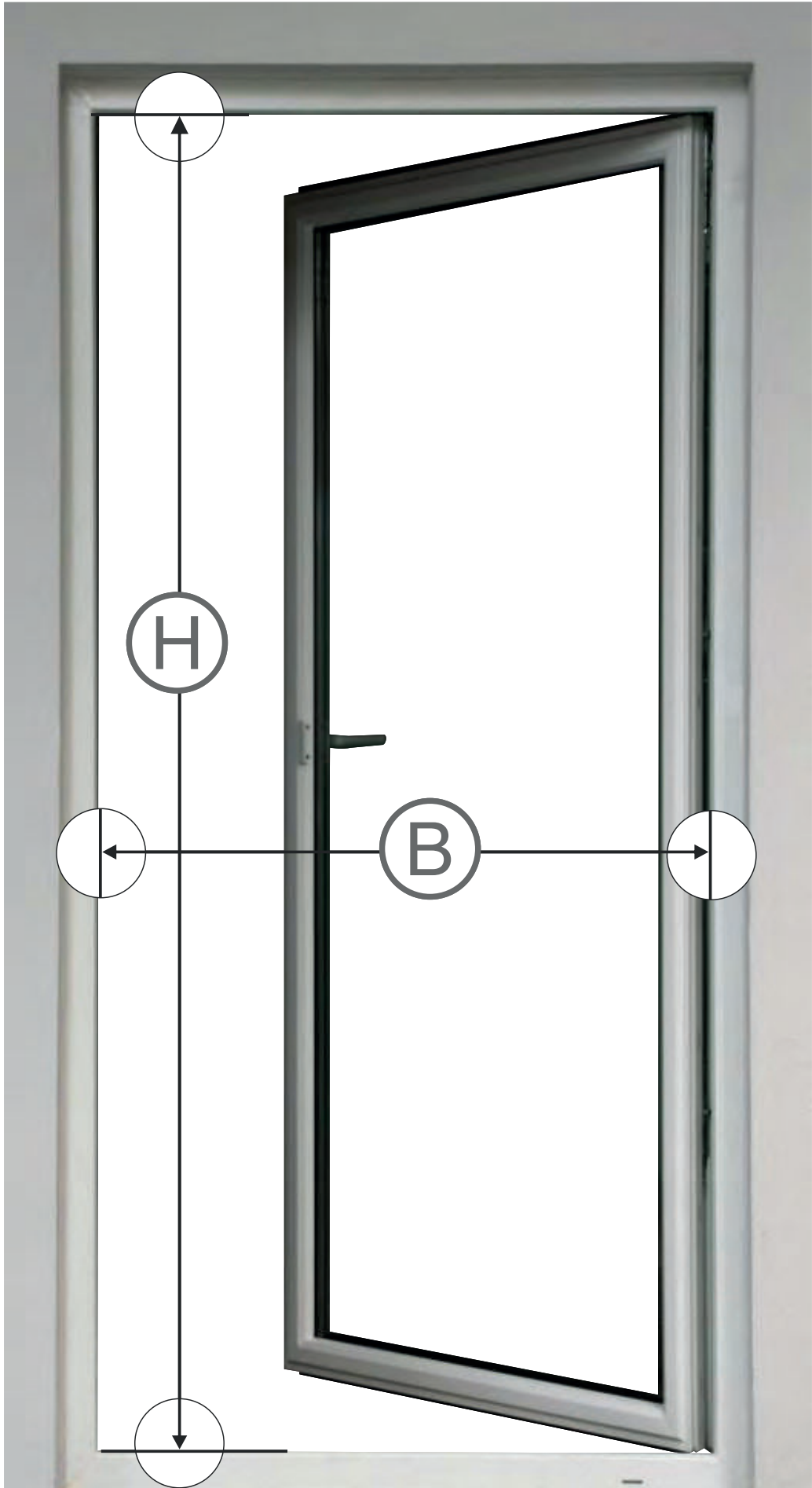

6

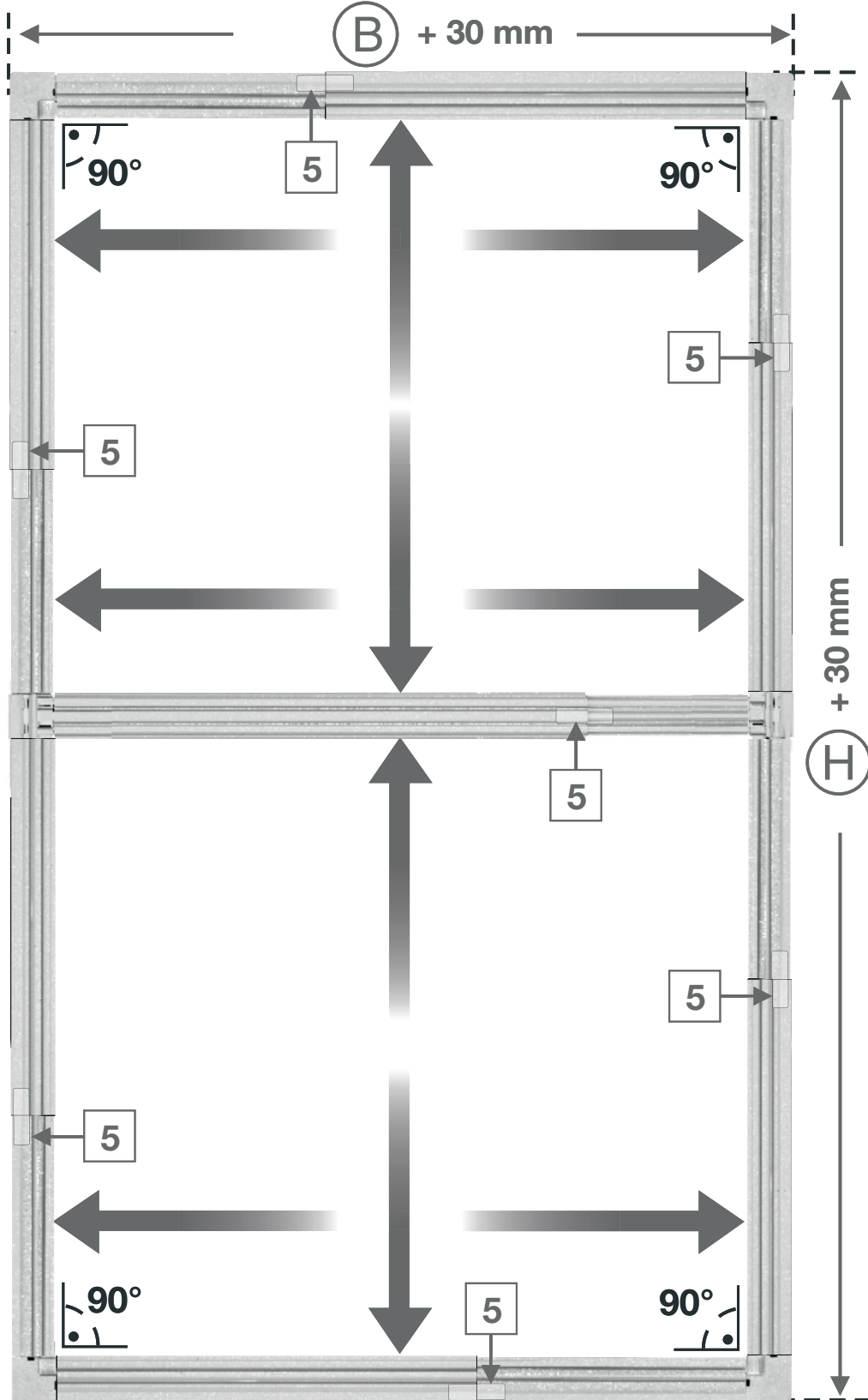
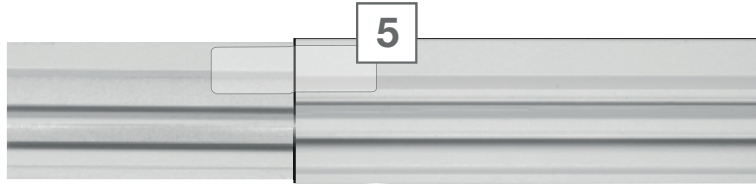

7

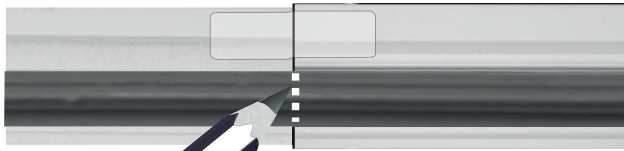

3 x 8

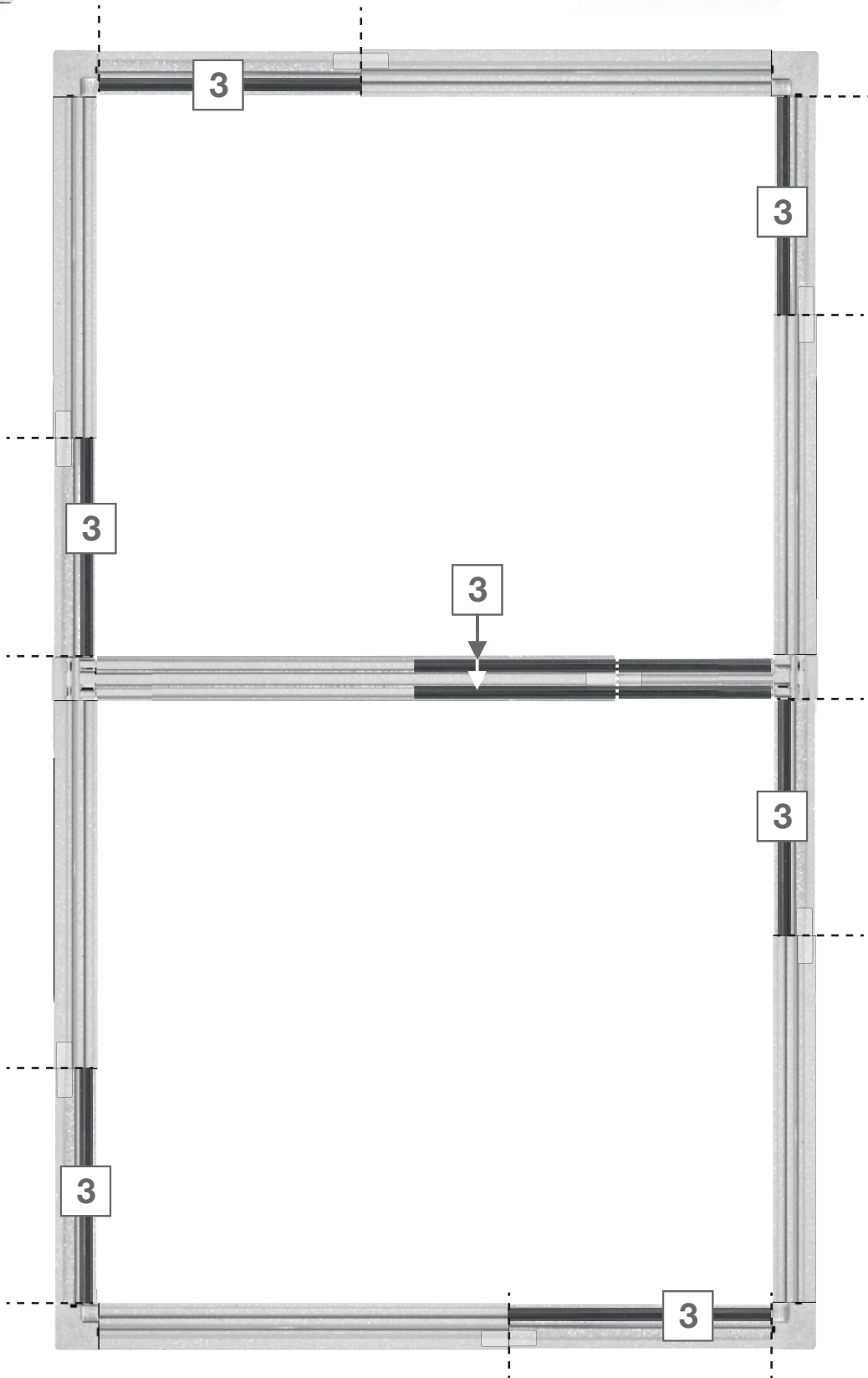

8

3

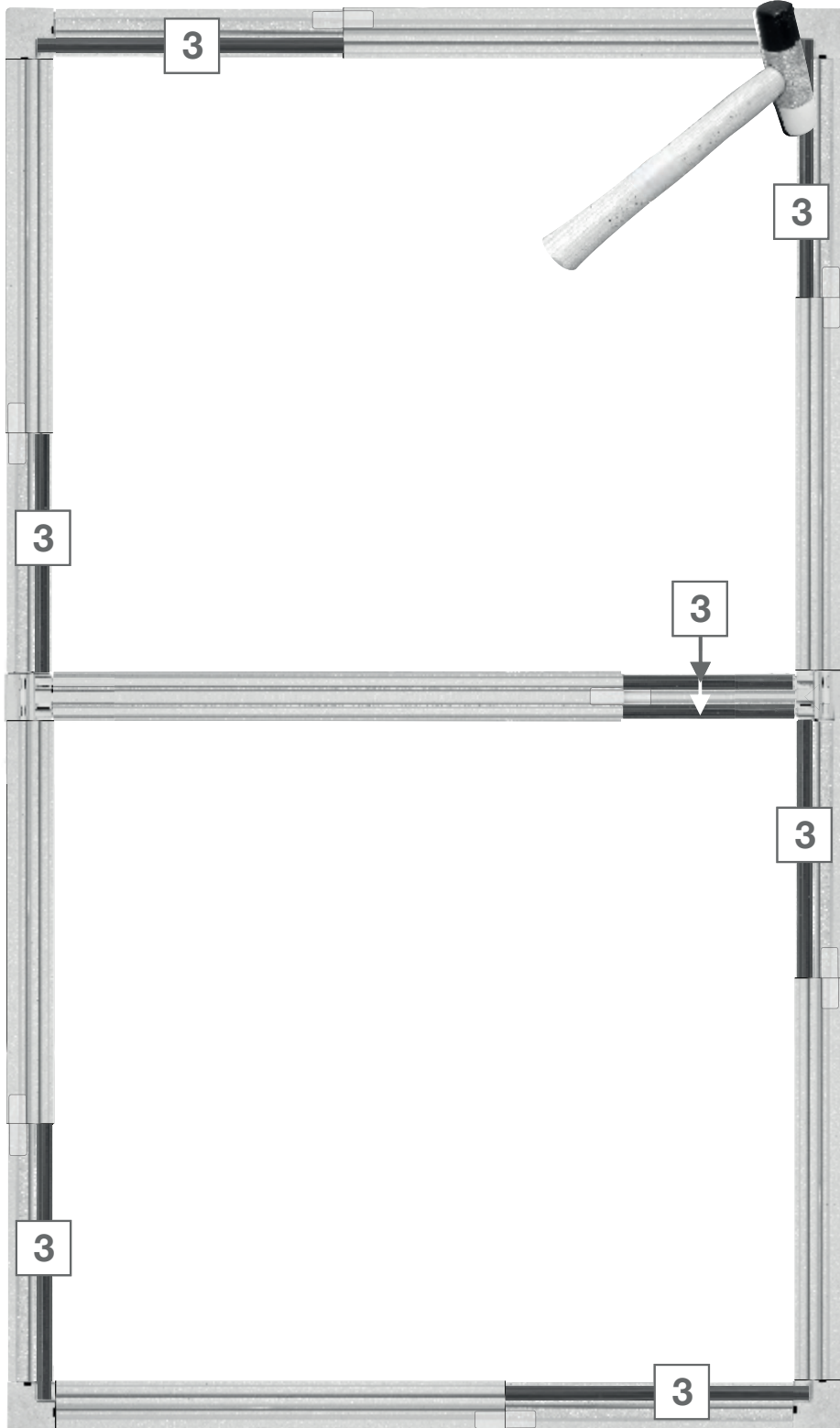
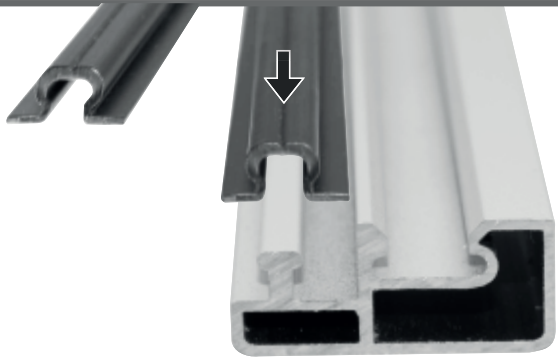
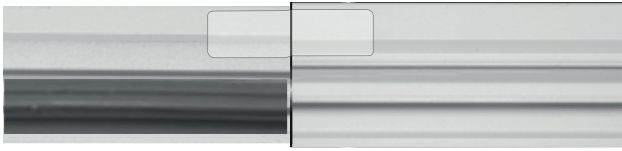

9

4 x 8

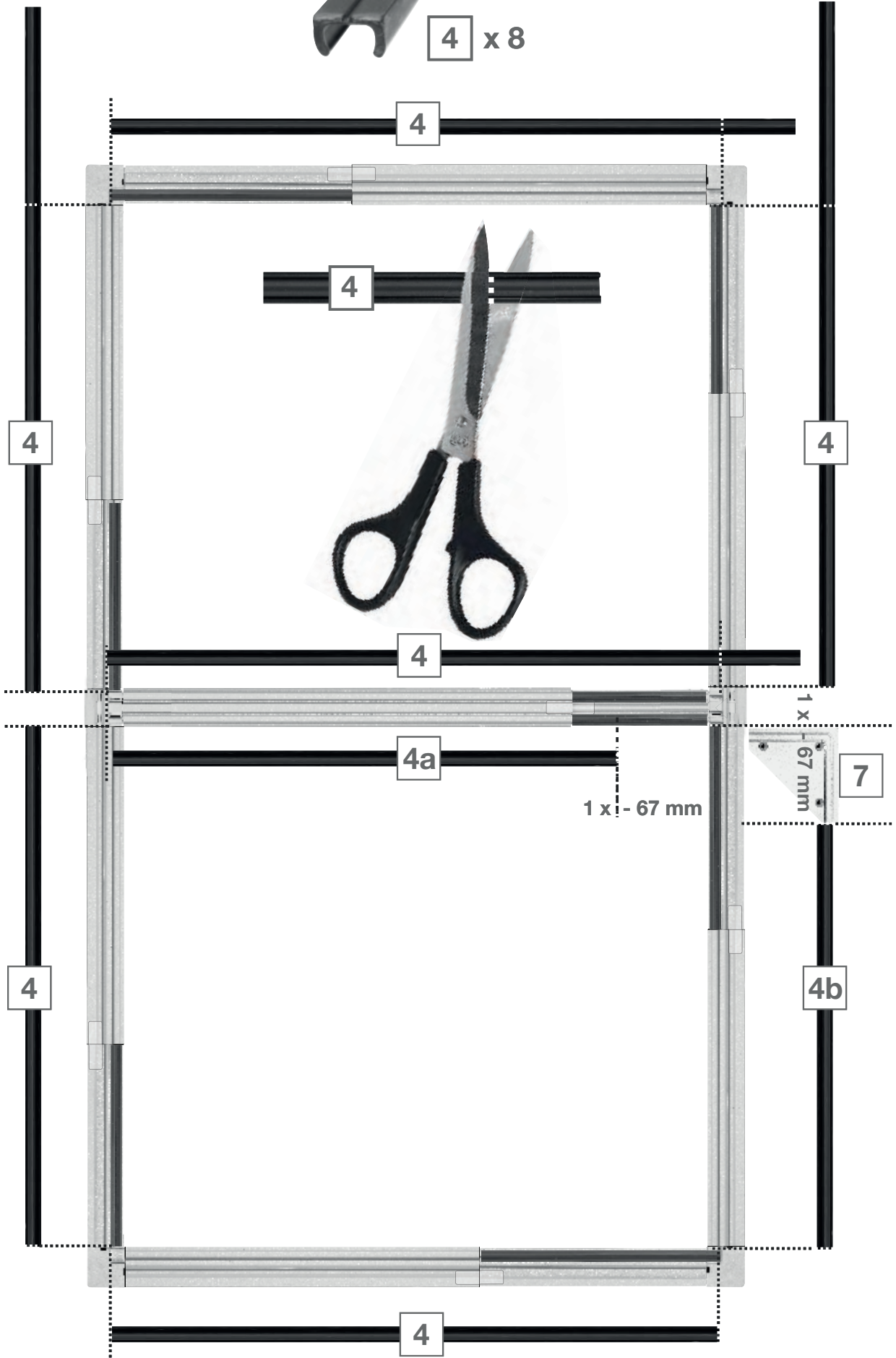

10

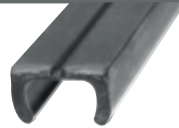

4 x 4

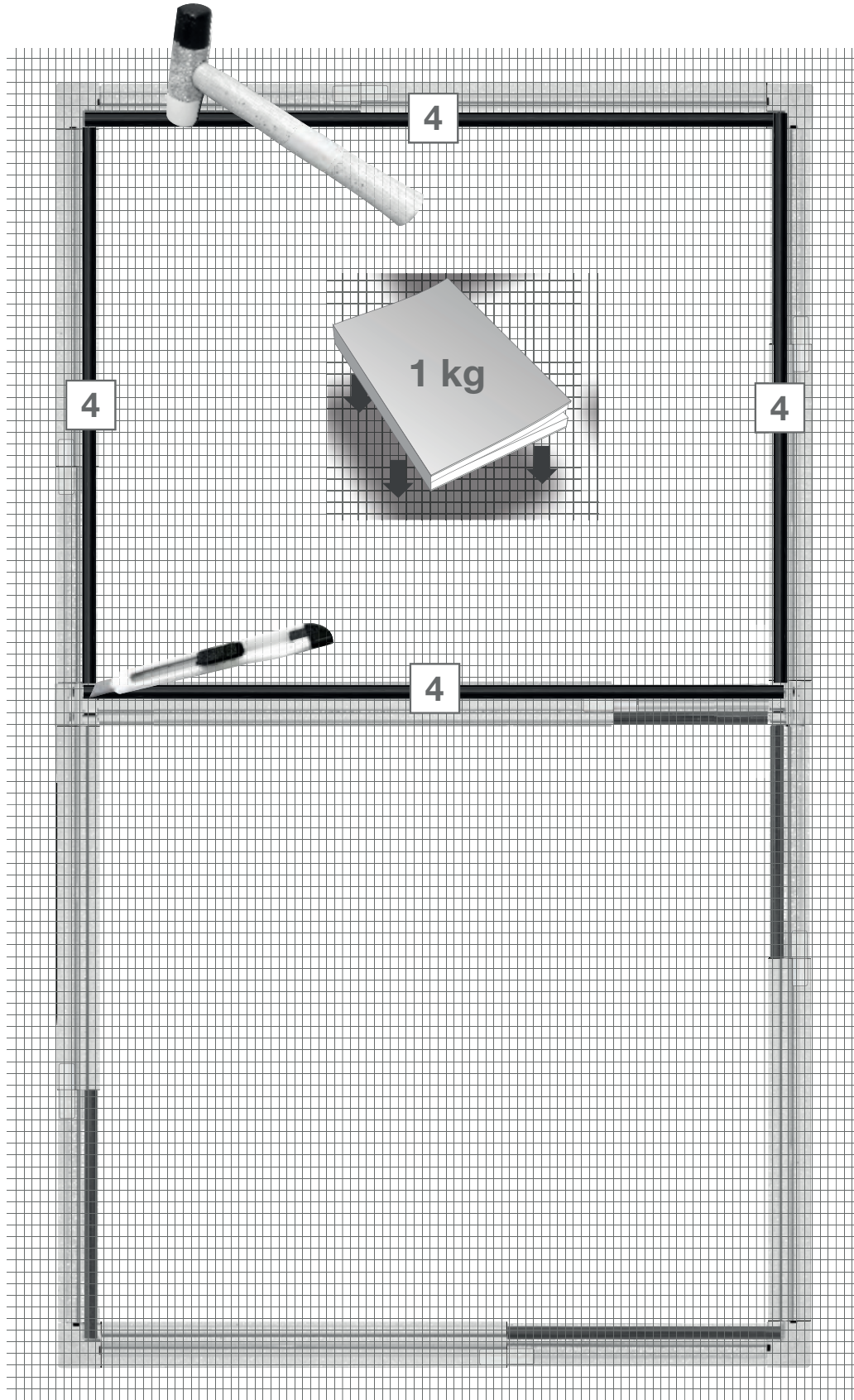
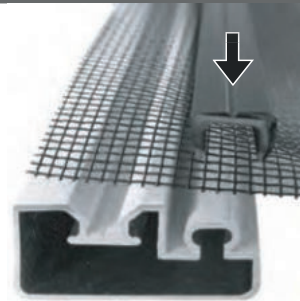

11

4 x 4

6

OPT A

7 1 x

8 1 x

7 3x 2,9x9,5

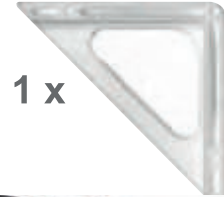
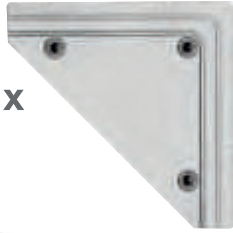

7

3x 2,9x9,5

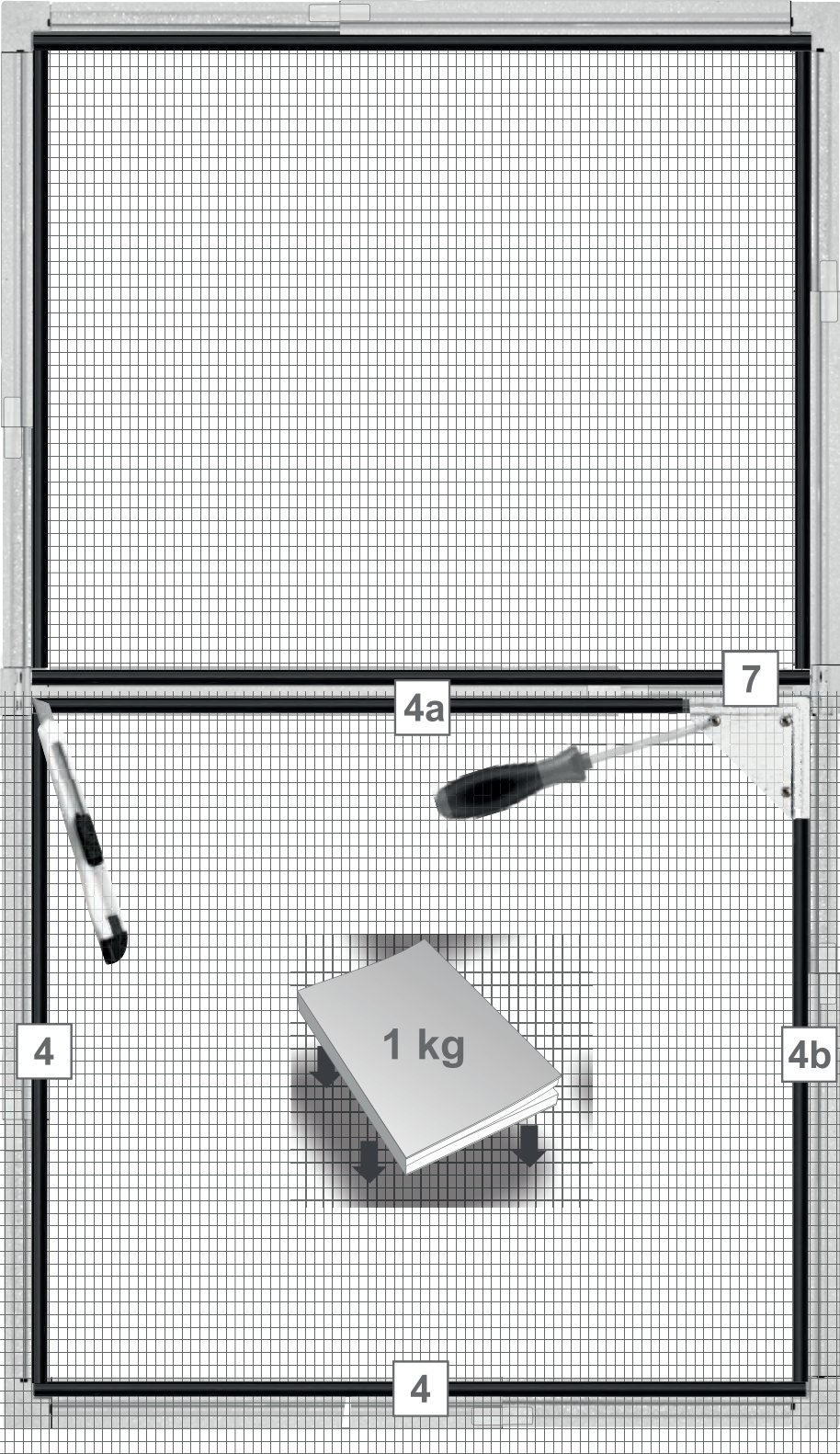

8 1 x

7 3 x 2,9 x 9,5

4

1 kg

4b

4

12

OPT A

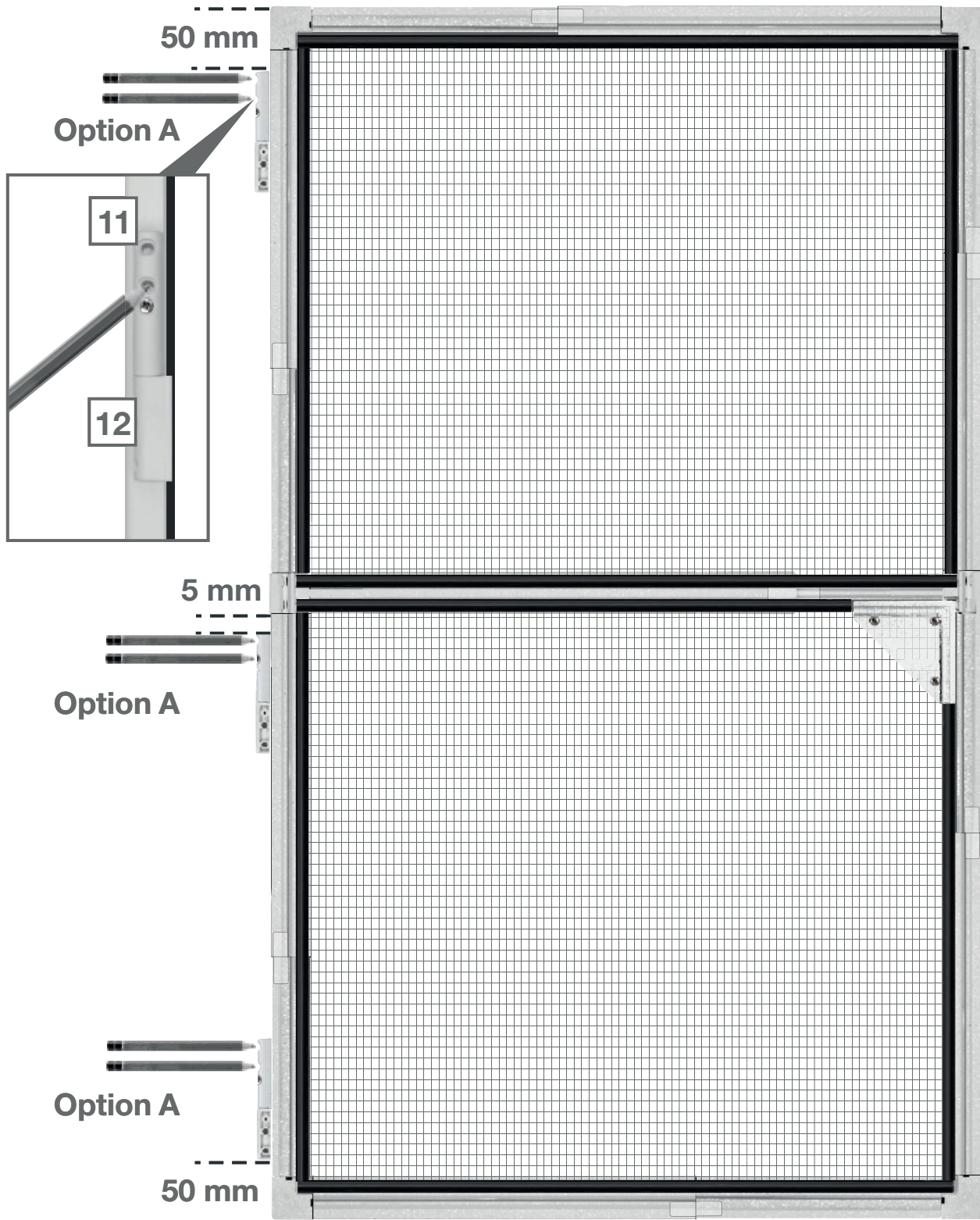
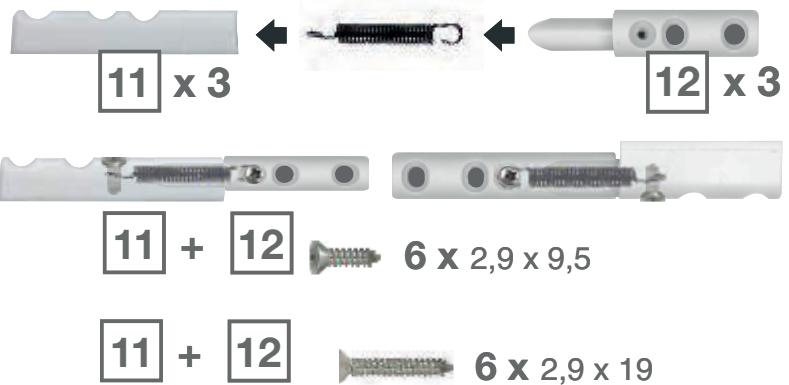

13

OPT A



2 x 2,9 x 19

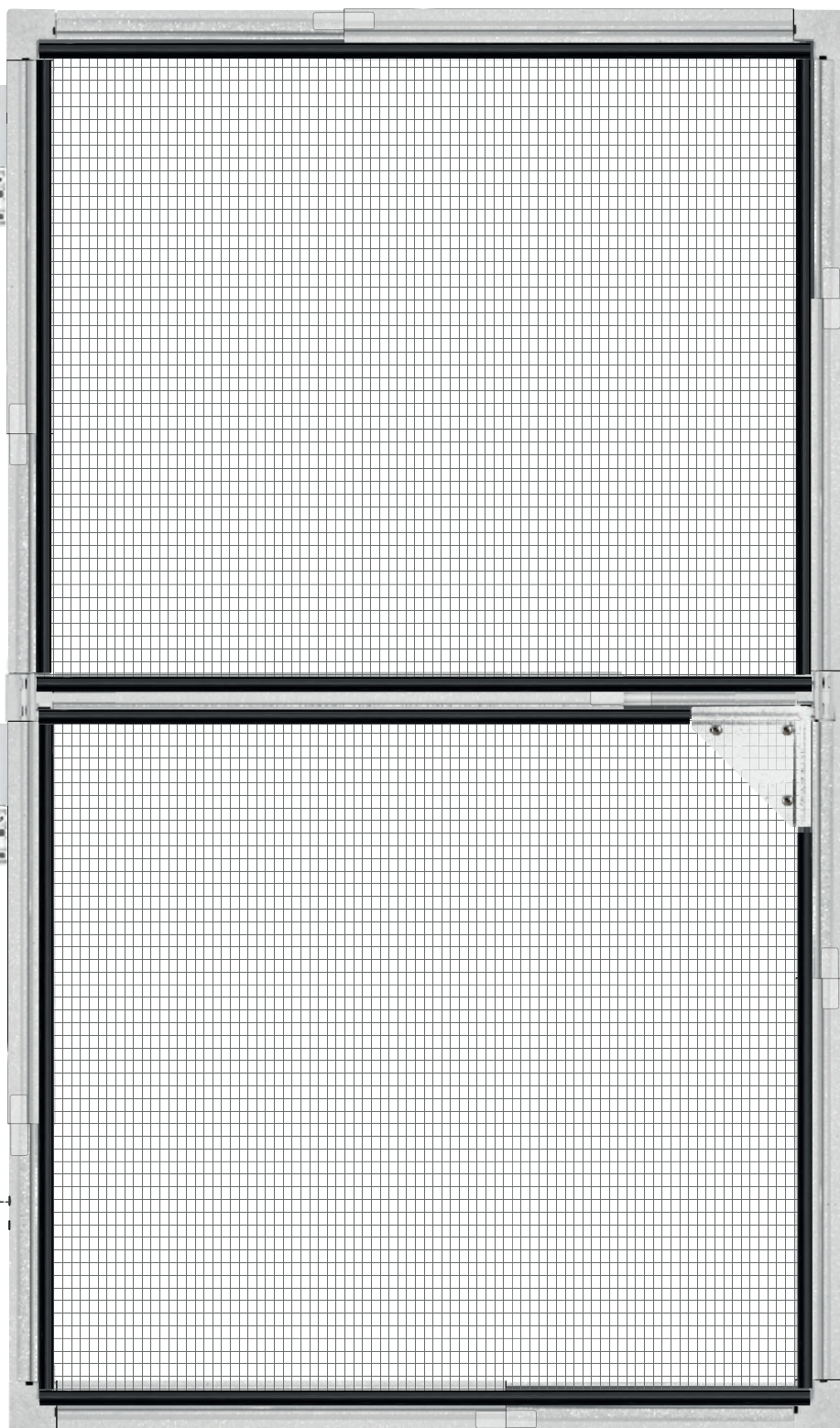

14

OPT A

13



2 x

13



4 x 2,9 x 9,5

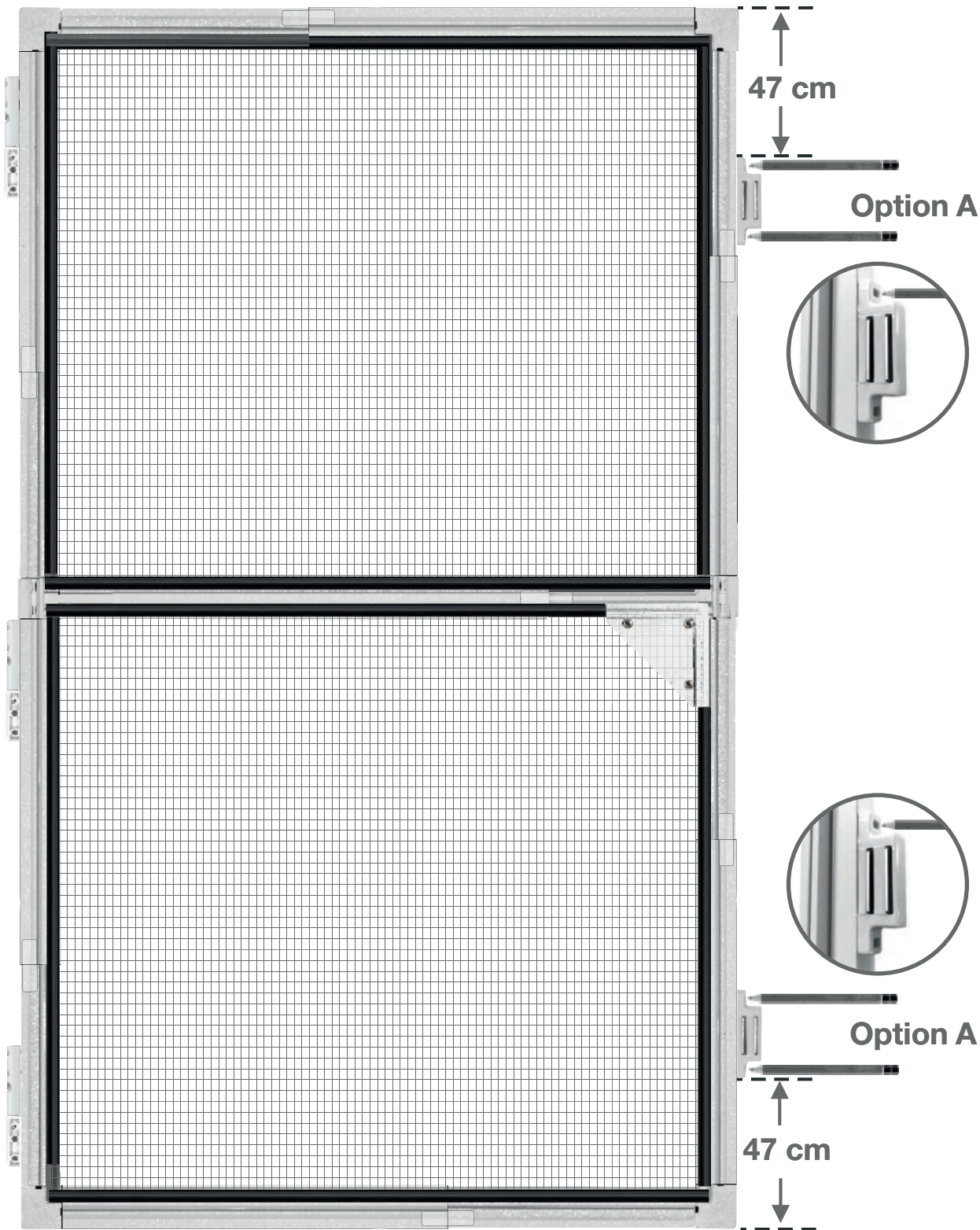

47 cm

Option A

Option A

47 cm

15

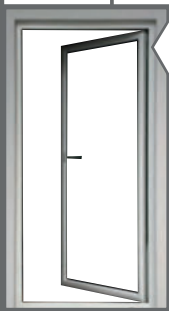

OPT A

13



2 x



4 x 2,9 x 9,5



2,5 mm

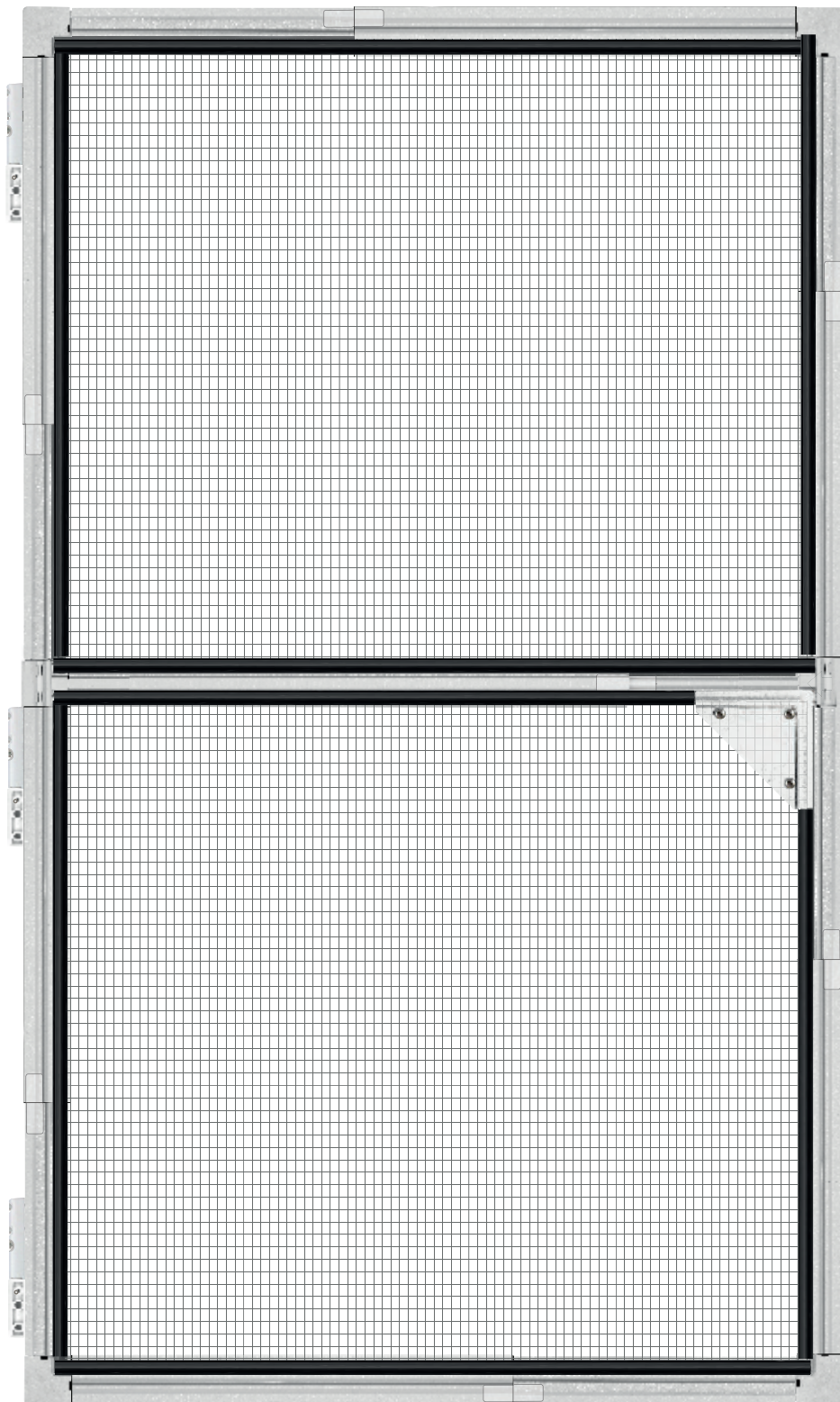

2 x 2,9 x 9,5



16

OPT B

7 1 x

8 1 x

7 3 x 2,9 x 9,5

4 x 4

6

8

1 x

7

3 x 2,9 x 9,5

4b

1 kg

4

4

7

4a

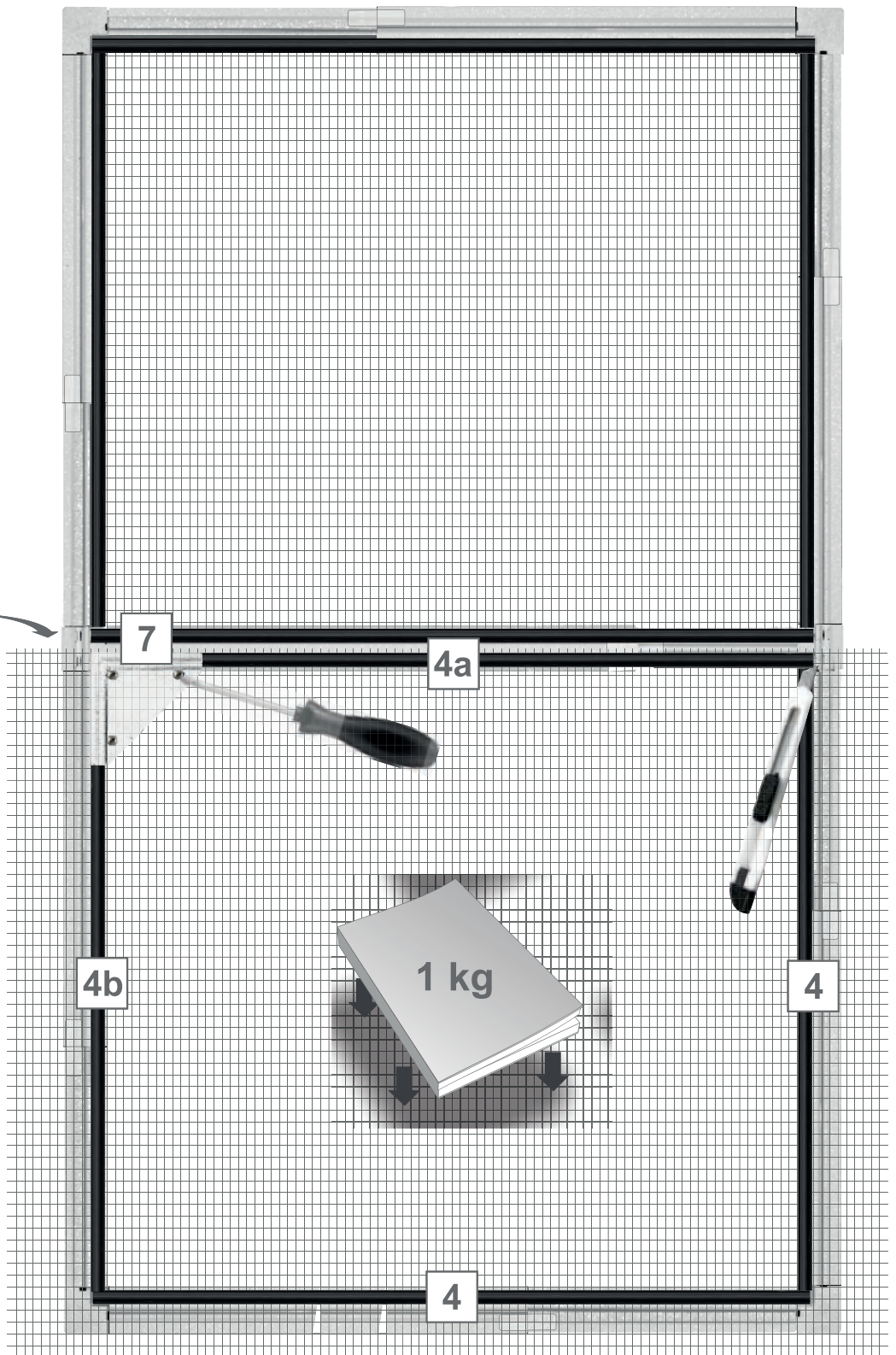
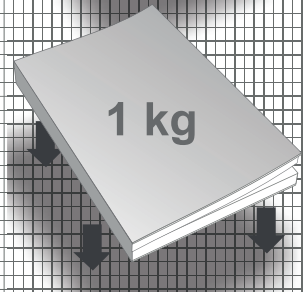
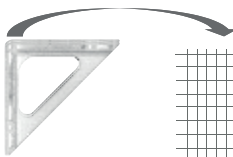

17

OPT B



11 x 3

12 x 3



11 + 12  6 x 2,9 x 9,5

11 + 12  6 x 2,9 x 19

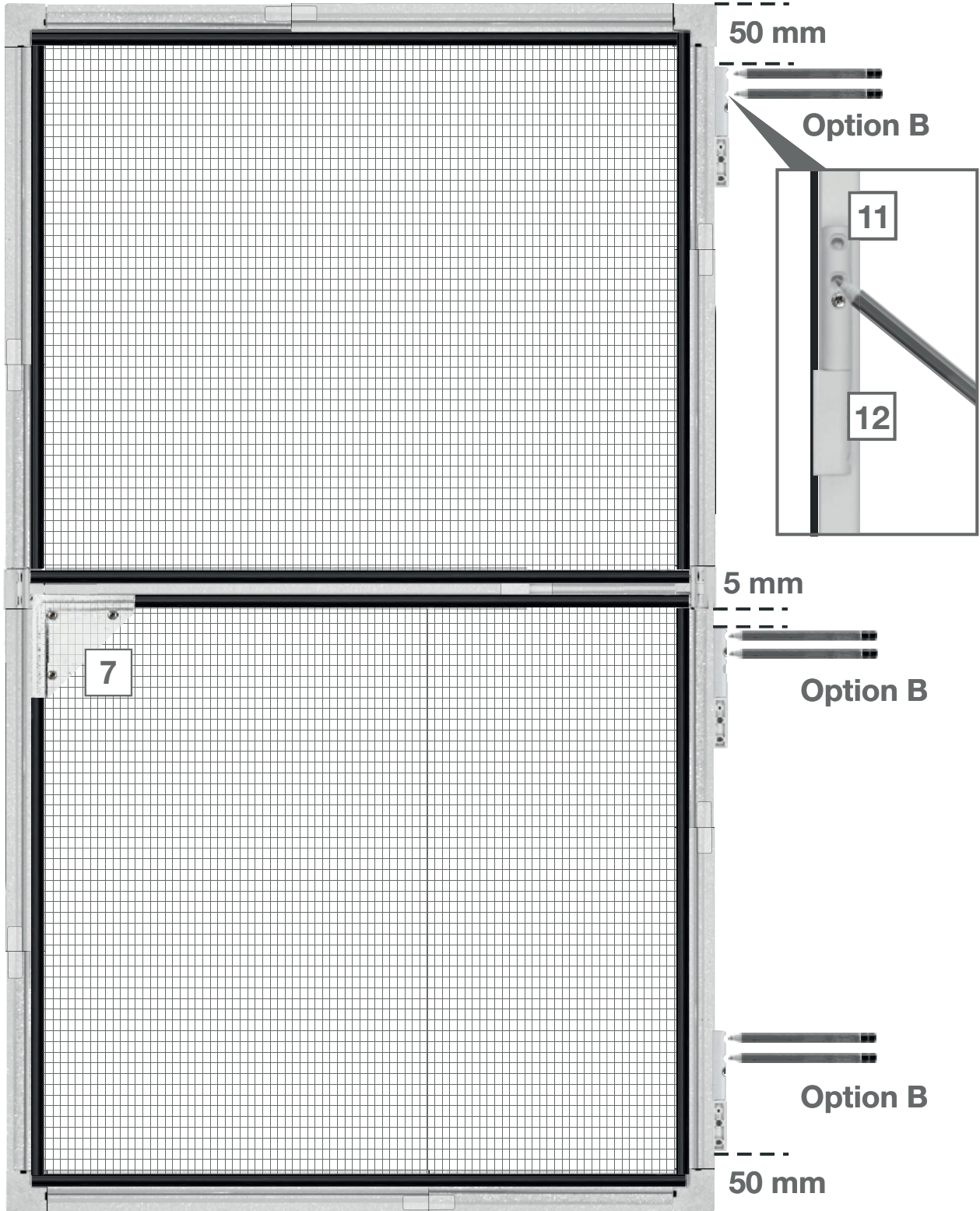

18



OPT B

∅ 2,5 mm



11 6 x 2,9 x 19

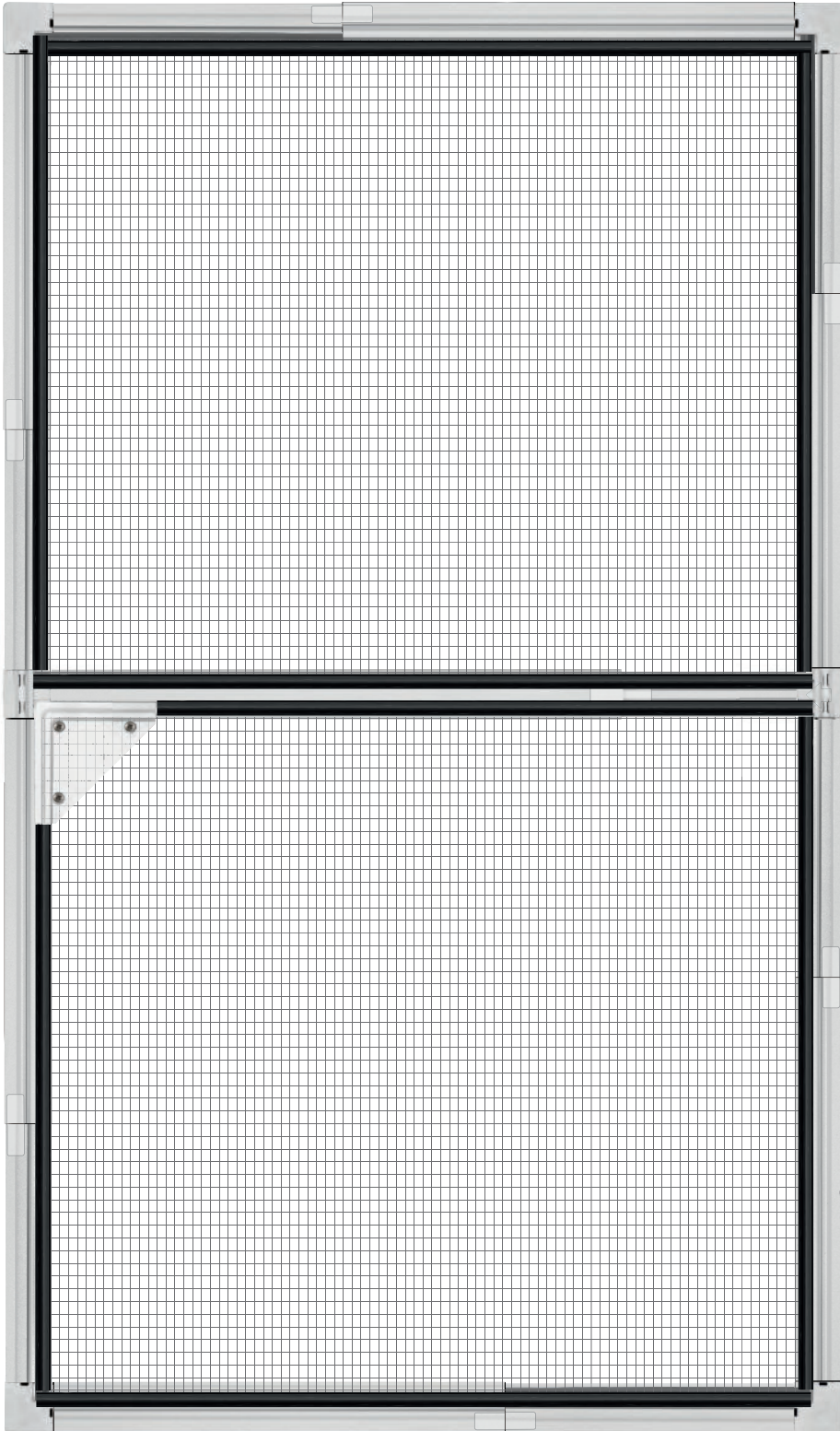

2 x 2,9 x 19

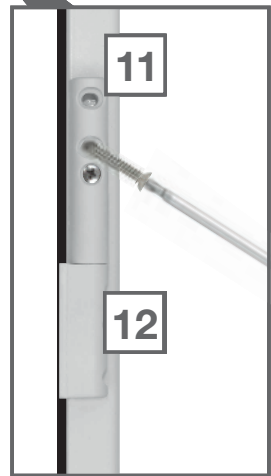

11

12



19

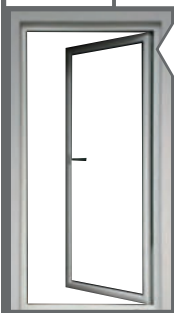

OPT B

13



2 x

13



4 x 2,9 x 9,5

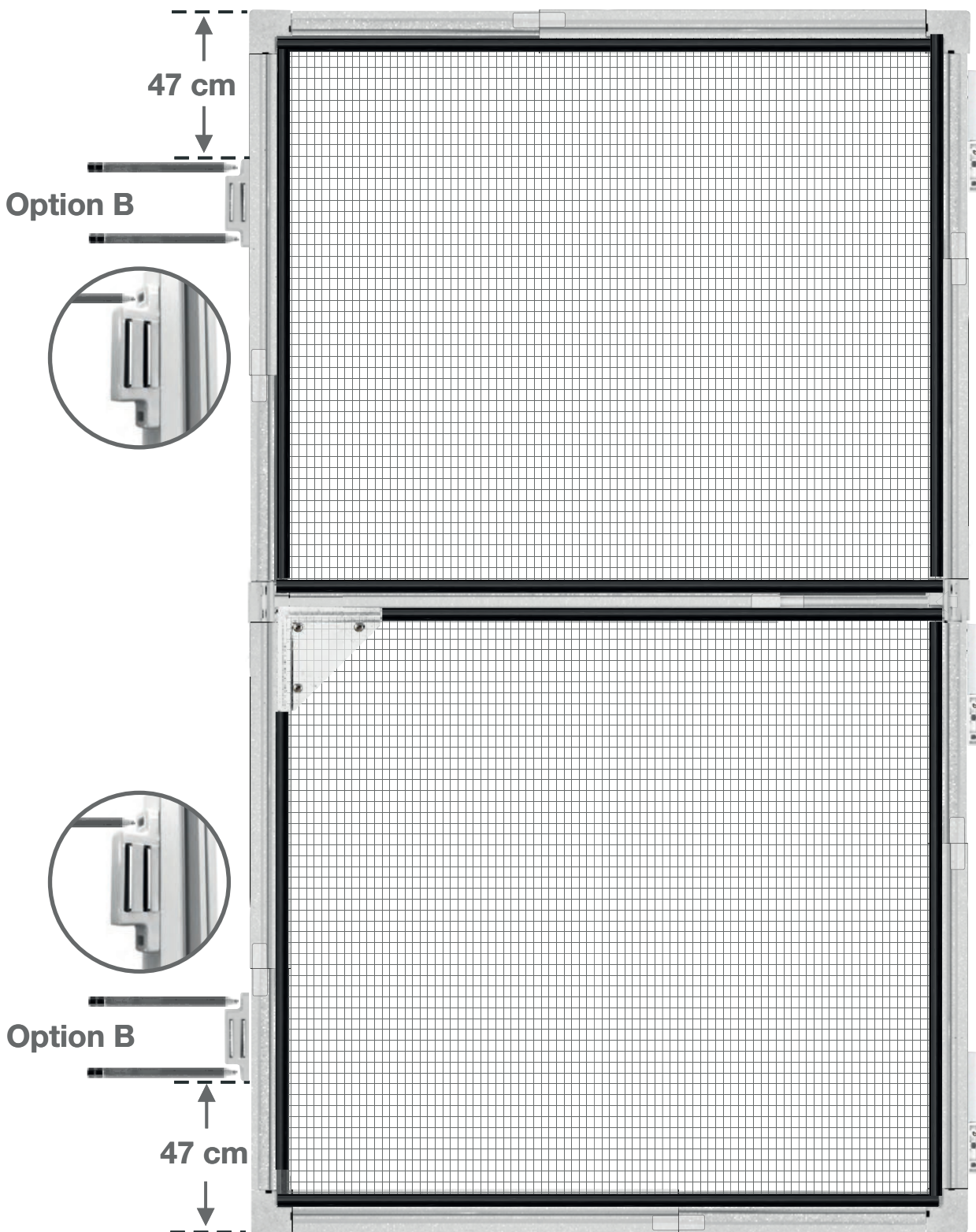

20

OPT B

13

2 x

Ø2,5 mm

4 x 2,9 x 9,5

2 x 2,9 x 9,5

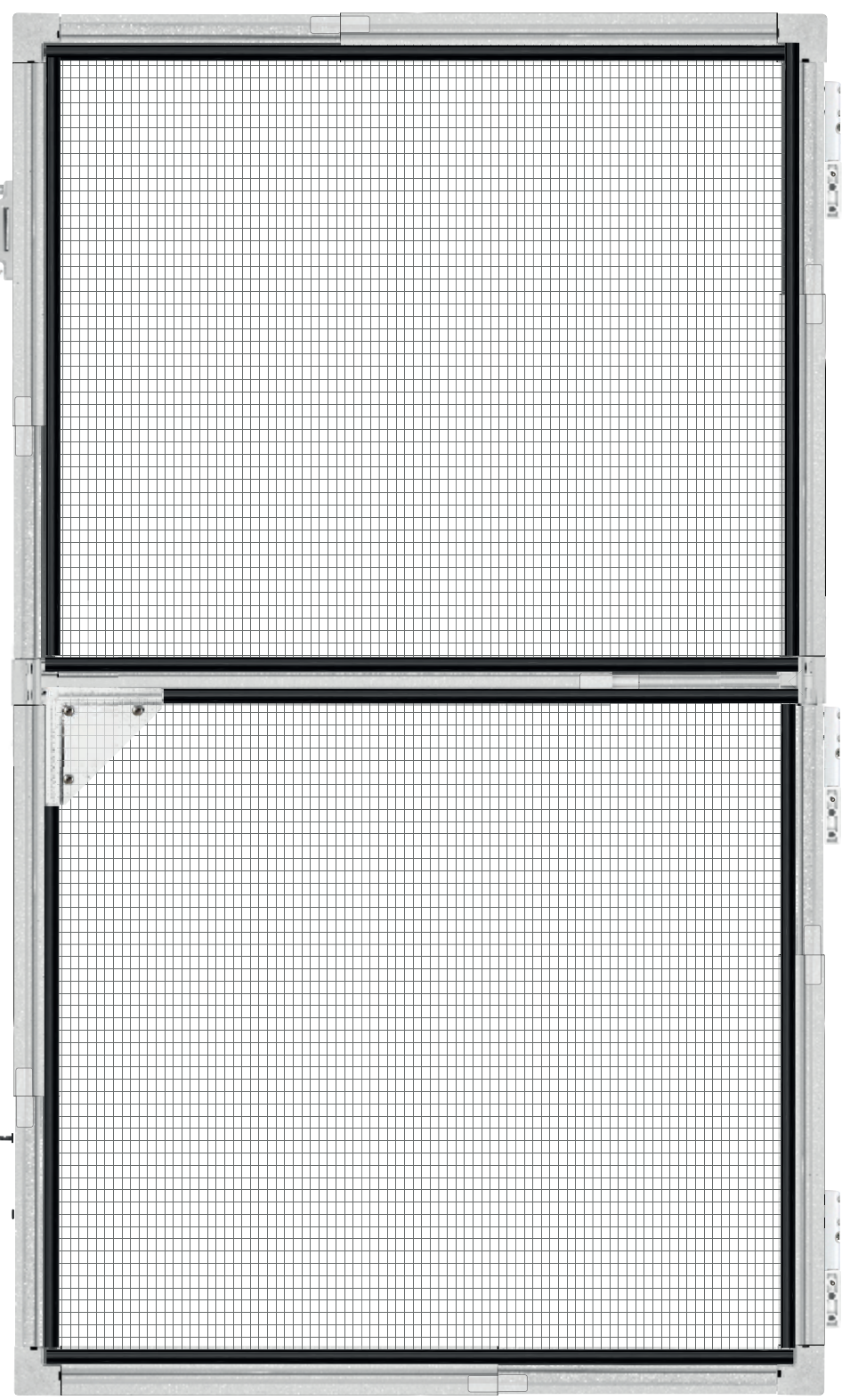
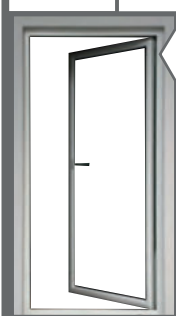

21

13 2 x

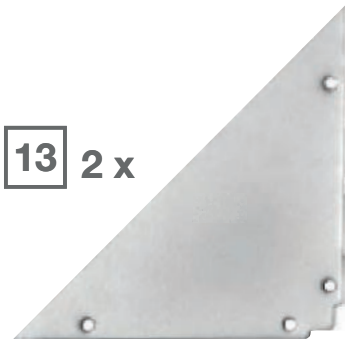

8 x 2,9 x 9,5

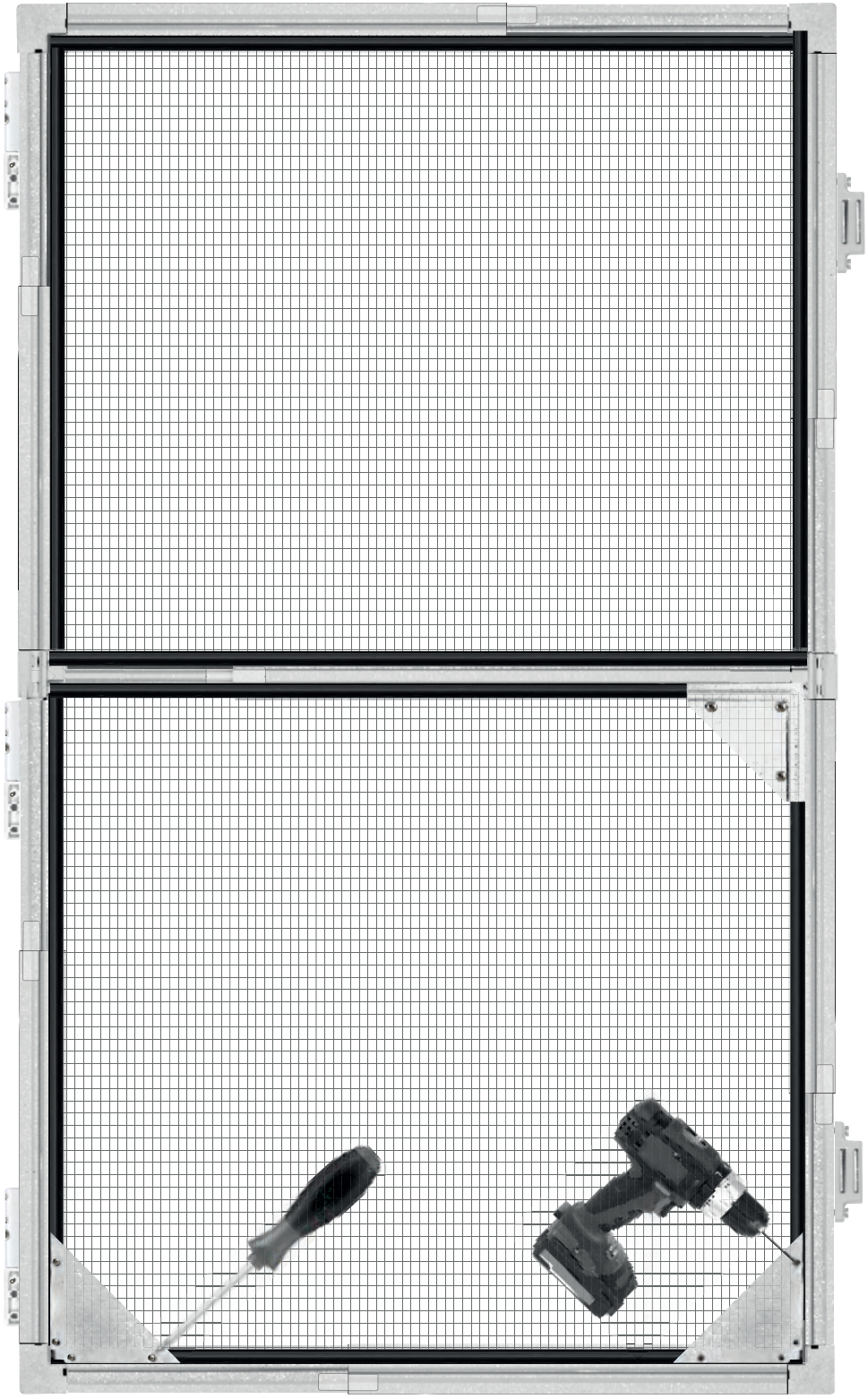

22

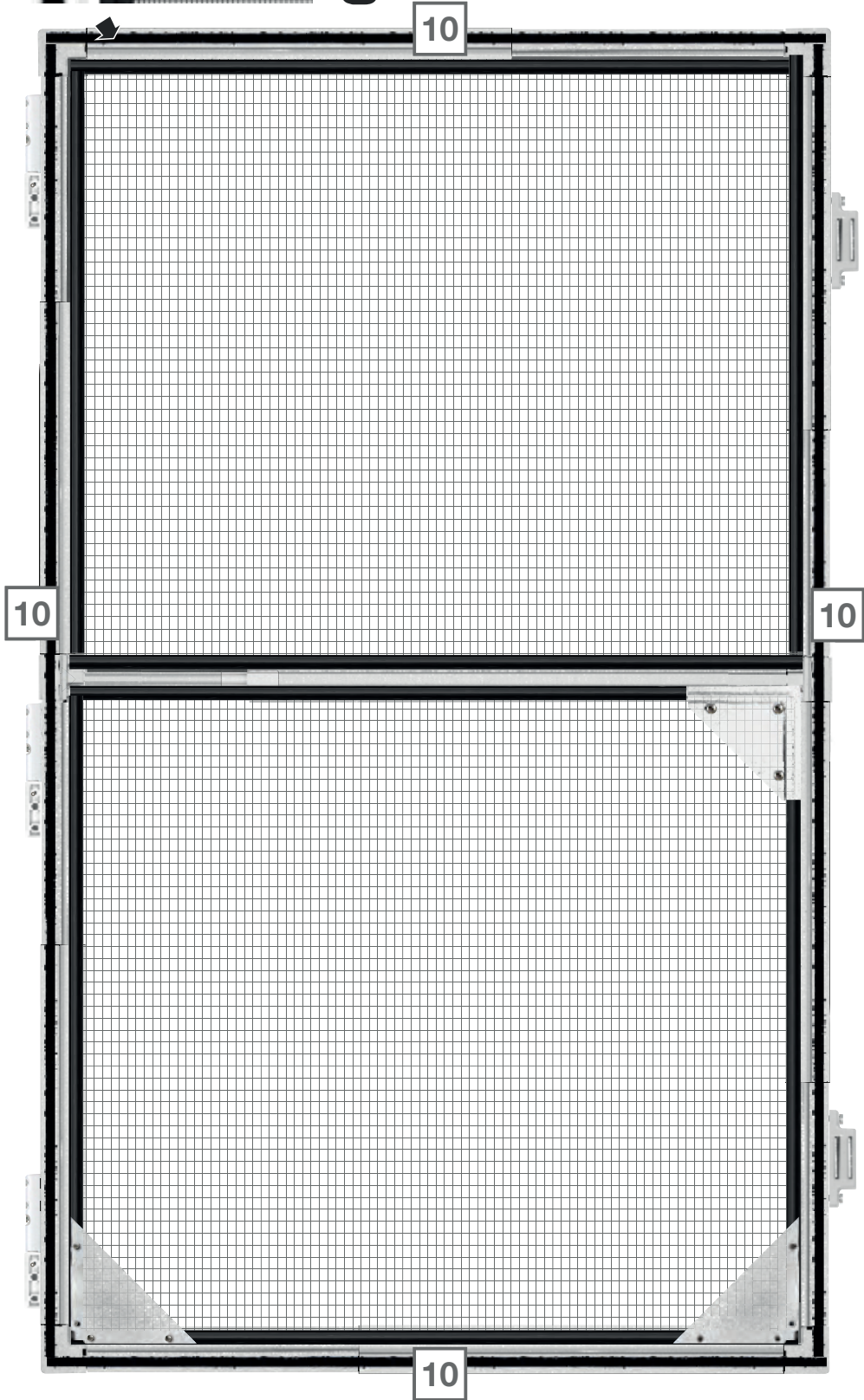

180°

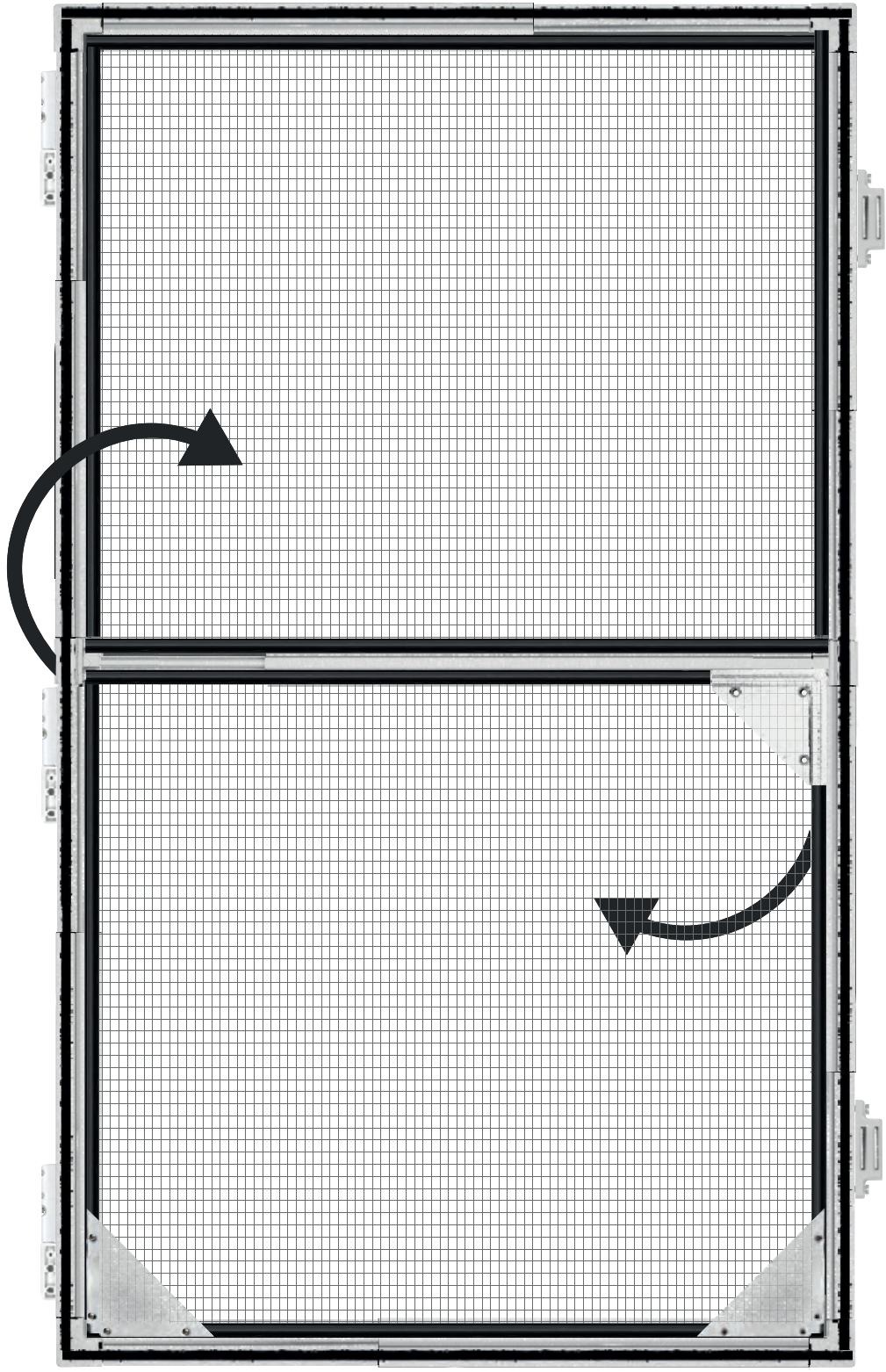

24

1
4 x



2A
1 x



2B
1 x

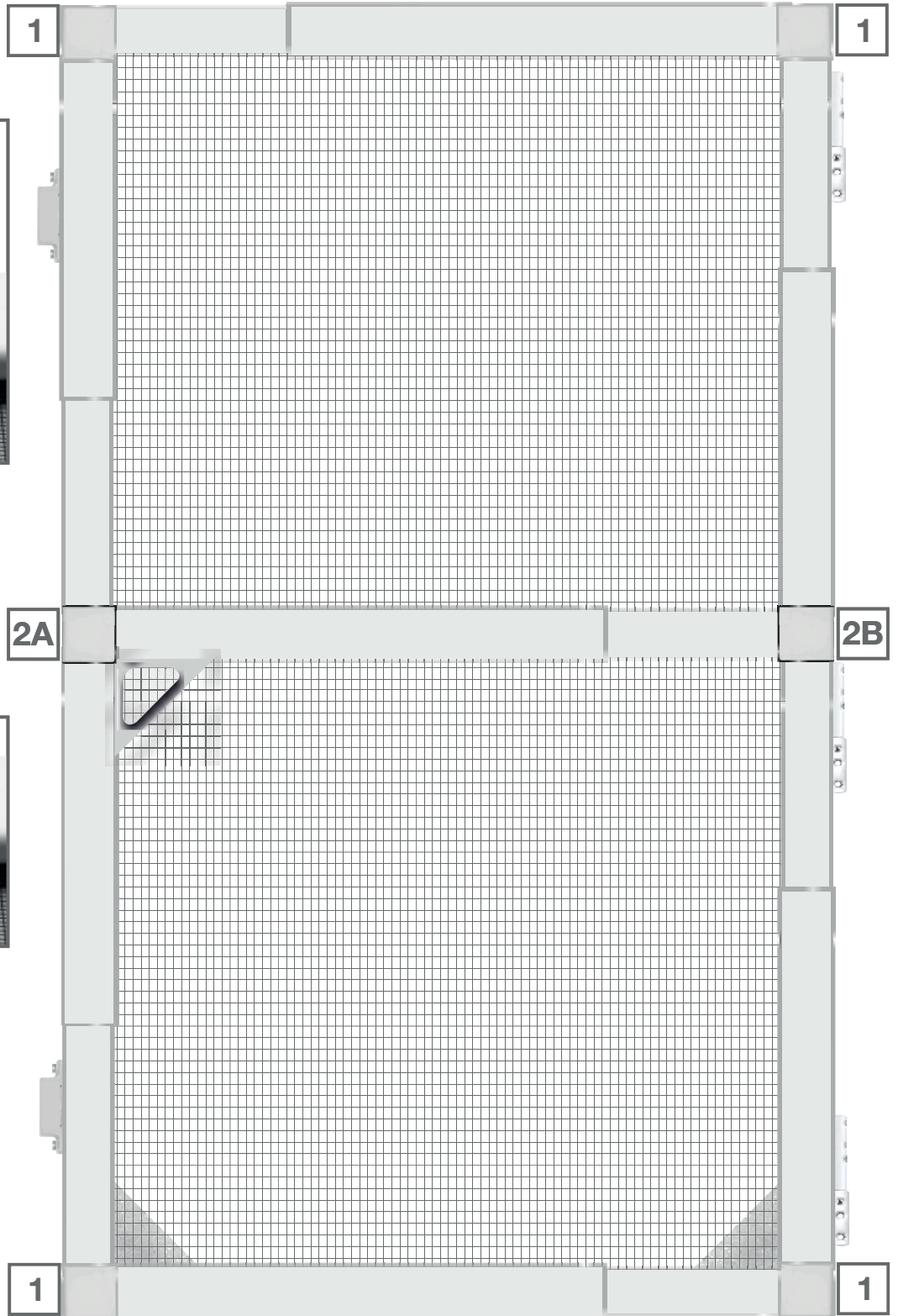
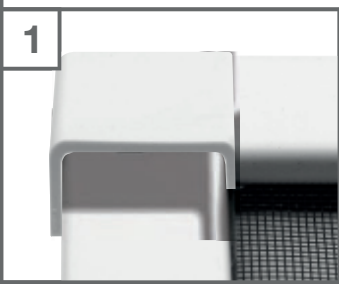
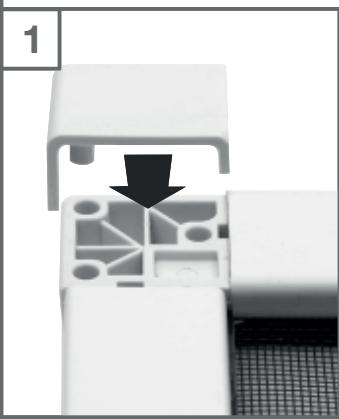

25



OPT A

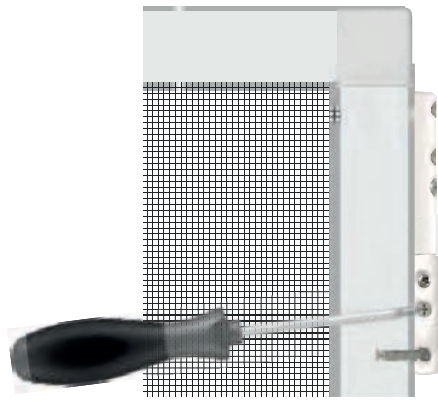



12

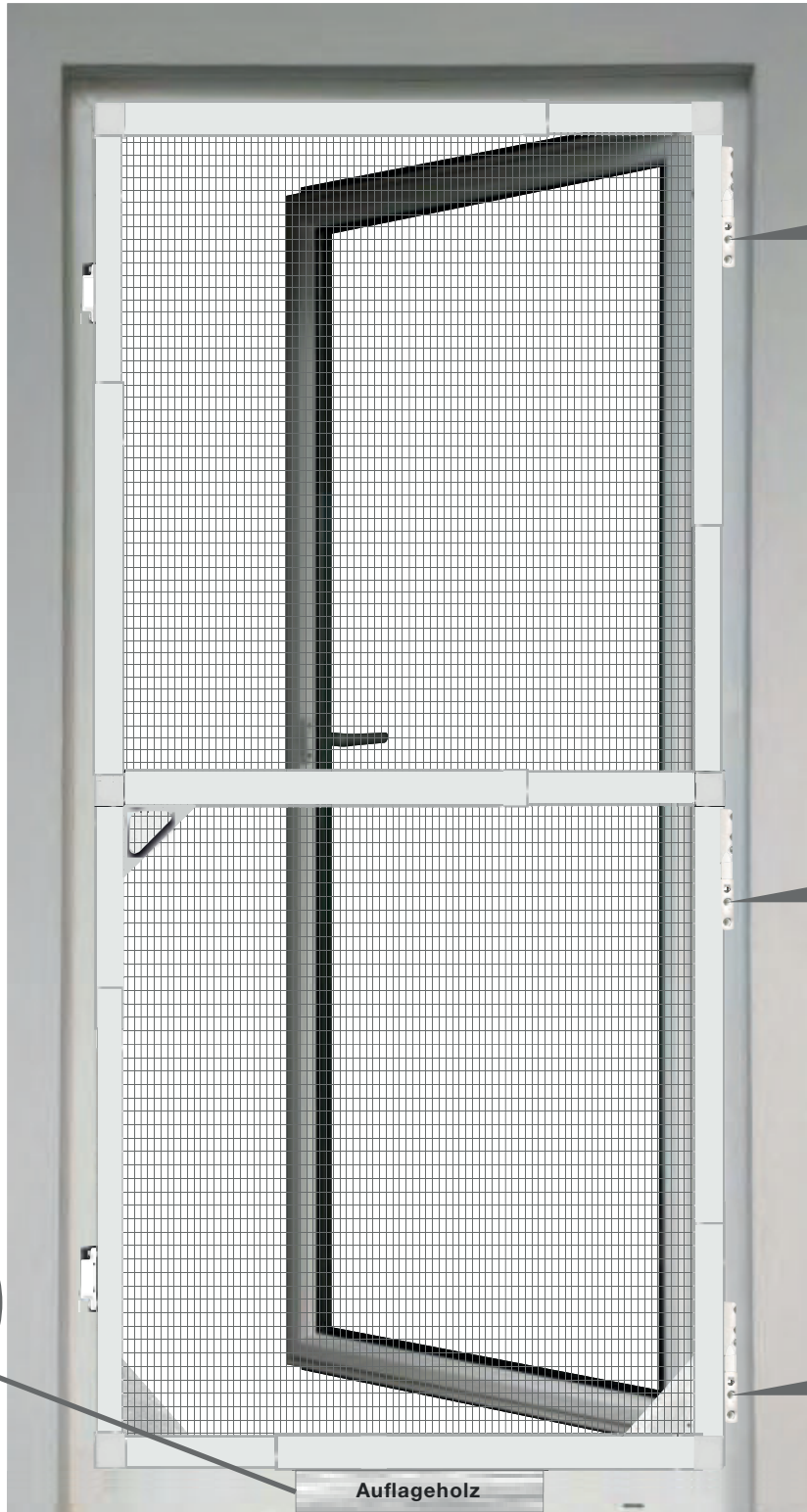

6 x 2,9 x 19



2 x 2,9 x 19

2 x 2,9 x 19

2 x 2,9 x 19

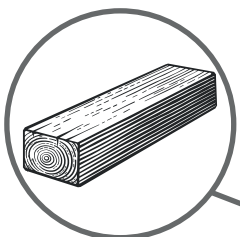

Auflageholz

26

OPT B



12  6 x 2,9 x 19

2 x 2,9 x 19

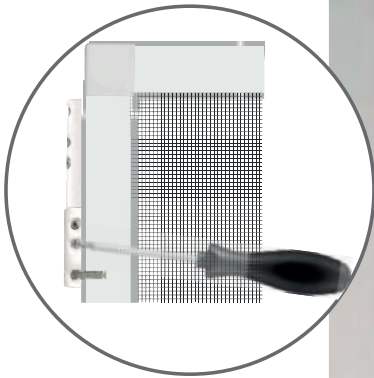

2 x 2,9 x 19

2 x 2,9 x 19

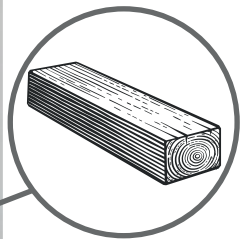

Auflageholz

27

14

2 x

4 x 2,9 x 9,5



OPT A

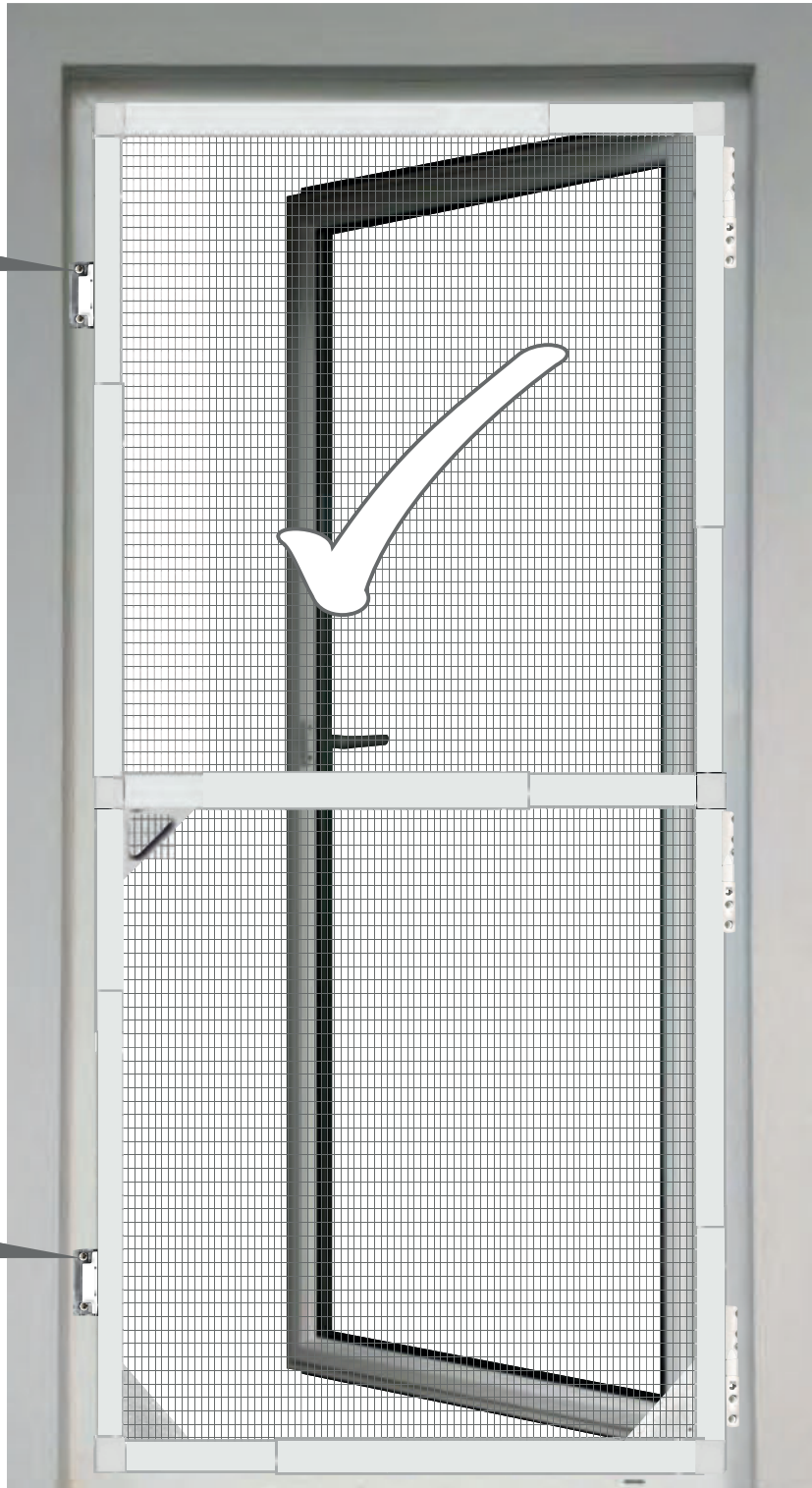
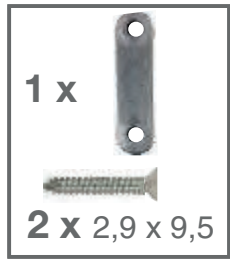
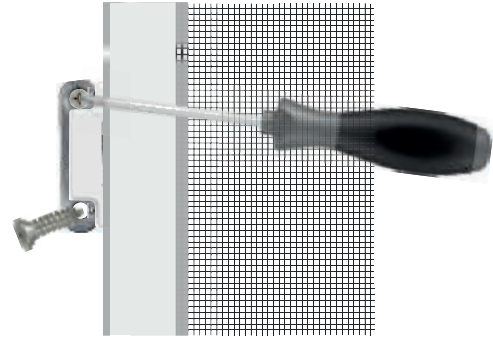
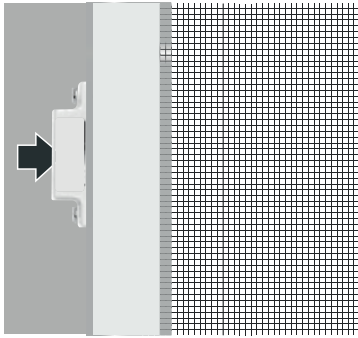

28

OPT B

14

2 x

4 x 2,9 x 9,5

