

# Matic

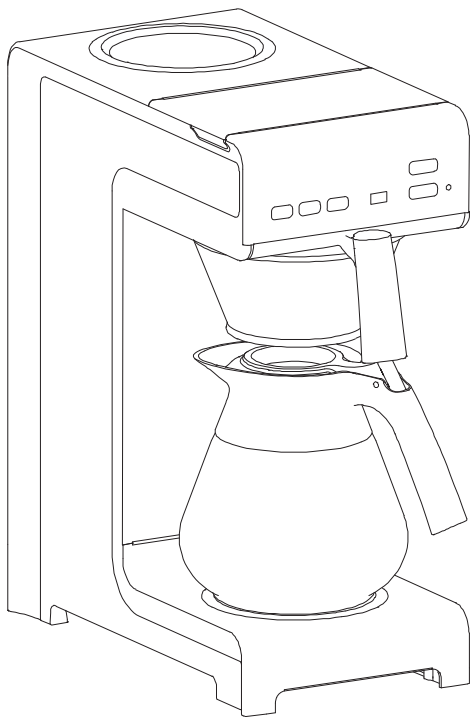

**Matic**

Model nr.: • MTCx-0xx  
• MTCTW-0xx

User manual  
Mode d'emploi Utilisateur  
Gebraucher Handbuch  
Gebruiksaanwijzing  
Användarmanualen  
Brukerhåndbok  
Brugsanvisningen  
Käyttäjän käsikirja  
Manual del usuario  
Manual do utilizador  
Manuale per l'utente  
Εγχειρίδιο χρήσης  
Prostudujte uživatelskou  
Podręcznik użytkownika  
Manualul utilizatorului  
Руководство пользователя  
Kullanıcı kilavuzu  
使用者手冊  
ユーザーマニュアル  
사용자 설명서

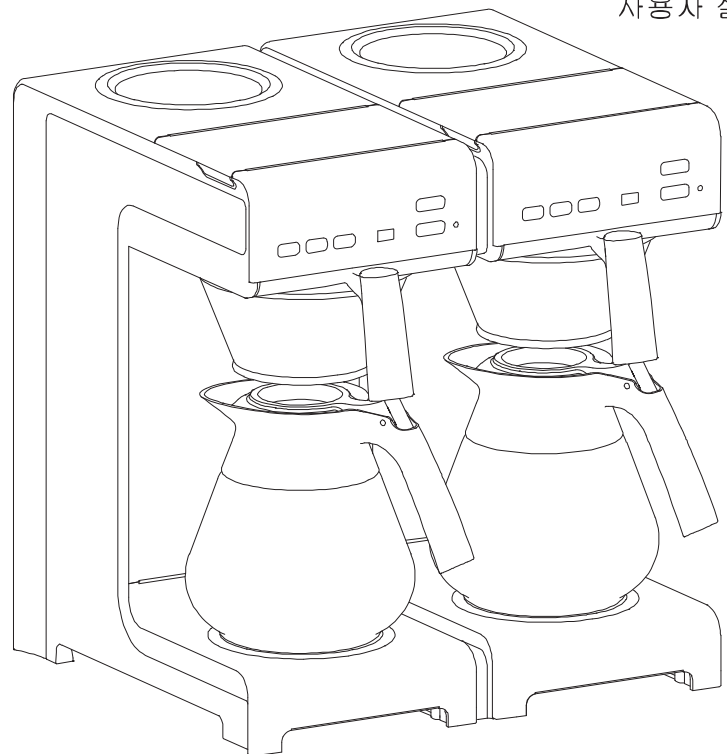

**Matic  
Twin**



English  
Français  
Deutsch  
Nederlands  
Svenska



Norsk  
Dansk  
Suomi  
Español  
Português

Italiano  
Ελληνικά  
Česky  
Polski  
Română



Русский  
Türkçe  
Հայերեն  
한국어

Safety book  
Sommaire des sécurités  
Sicherheitsvorschriften  
Veiligheidsboek  
Säkerhetsföreskrifter



Sikkerhedsbok  
Sikkerhedsbog  
Turvallisuuohjeet  
Libro de seguridad  
Instruções de segurança

Prescrizioni di sicurezza  
Έντυπο ασφαλείας  
Bezpečnostní kniha  
Wskazówki bezpieczeństwa  
Carte instructaj



Инструкция по эксплуатации  
Güvenlik kitabı  
安全冊子  
安全說明書  
안전 지침서

Accessories  
Accessoires  
Zubehör  
Toebehoren  
Tillbehör



Tilbehør  
Valgbar  
Lisälaitteet  
Accesorios  
Acessórios

Accessori  
Εξαρτήματα  
Příslušenství  
Akcesoria  
Accesorii



Аксессуары  
Aksesuarlar  
附件  
備品  
악세서리

Wait  
Patienter  
Warten  
Wachten  
Vänta



Vent  
Vent  
Odota  
Esperar  
Aguardar

Attendere  
Αγαμονή  
Čekejte  
Czekaj  
Aşteaptă



Ждите  
Bekle  
等待  
待つ  
기다림

Rinse  
Rinçer  
Spülen  
Afspoelen  
Sköjning



Skylle  
Rensning  
Huuhtelee  
Aclarar  
Enxaguamento

Lavaggio  
Ελαφριά πλύση  
Vypláchnout  
Plukanie  
Clătire



Прополоскать  
Durula  
沖洗  
すすぐ  
세척

Safety gloves  
Gants de sécurité  
Schutzhandschuh  
Veiligheidshandschoenen  
Skydds handskar



Hansker  
Sikkerheds handsker  
Suojahanskat  
Zapatos de seguridad  
Luvas de protecção

Guanti di protezione  
Γάντια ασφαλείας  
Ochranné rukavice  
Rękawiczki ochronne  
Mānuši protectje



Защитные перчатки  
Güvenlik eldivenleri  
安全手套  
安全手袋  
안전용 장갑

Safety goggles  
Lunettes de sécurité  
Schutzbrille  
Veiligheidsbril  
Skydds glasögon



Vernebriller  
Sikkerhedsbriller  
Suojalasit  
Gafas de seguridad  
Óculos de protecção

Occhiali di protezione  
Γυαλιά ασφαλείας  
Ochranné brýle  
Okulary ochronne  
Ochelari protectje



Защитные очки  
Güvenlik gözlükleri  
護目鏡  
安全眼鏡  
안전용 안경

Dishwasher proof  
Lave-vaisselle autorisé  
Geschirrspülertauglich  
Vaattwasmaschine  
bestendig  
Tål maskindisk



Tåler oppvaskmaskin  
Maskinopvaske bestandig  
Astianpesukoneen kestävä  
Rest. para lavaplatos  
À prova de máquina de lavar  
louça

Idoneo per lavastoviglie  
Εγγυημένο για χρήση σε  
πλυντήριο πιάτων  
Myčka –důkaz  
Mycie w zmywarce  
dozwolone  
Spálátor veselá



Допускается чистка в  
посудомоечной машине  
Bulaşık makinası uyumlu  
可放於洗碗碟機清洗  
食器洗い機で使用可能  
접시세척기 사용금지

Moist cloth  
Chiffon humide  
Feuchtes Tuch  
Vochtige doek  
Fuktig trasa



Fuktig klut  
Fugtig klud  
Kostea pyyhe  
Trapo húmedo  
Pano húmido

Panno umido  
Υγρό πανί  
Vlhká látka  
Wilgotna szmatka  
Cârpă umedă



Влажная салфетка  
Nemli bez  
濕布  
濕った布  
젖은헝겂

Call distributor  
Appelez votre distributeur  
Händler anrufen  
Verkoopkantoor bellen  
Ring Leverantör



Ring leverandør  
Tilkald forhandler  
Soita jälleenmyyjälle  
Llame al distribuïdor  
Contacto importador

Chiamare il fornitore  
Καλέστε τον αντιπράσωπο /  
διανομέα  
Volejte dodavatele  
Teefon do dystrybutora  
Cheamă distribuitorul



Позвоните  
дистрибутору  
Çağrı distribütörü  
聯絡經銷商  
販売店に連絡して下さい  
전화 교환기



English  
Français  
Deutsch  
Nederlands  
Svenska



Norsk  
Dansk  
Suomi  
Español  
Português

Italiano  
Ελληνικά  
Česky  
Polski  
Română



Русский  
Türkçe  
정보  
說明

Information  
Information  
Information  
Informatie  
Information



Informasjon  
Information  
Informaatio  
Información  
Informação

Installation  
Installation  
Installation  
Installieren  
Installation



Installasjon  
Installation  
Asennus  
Instalar  
Instalação

Handling  
Fonctionnement  
Bedienung  
Bedienen  
Handhavande



Beþjening  
Beþjening  
Käsittely  
Operación  
Execução

Cleaning  
Nettoyage  
Reinigung  
Schoonmaken  
Rengöring



Vasking  
Rengöring  
Puhdistus  
Limpiar  
Limpeza

Descaling  
Détartrage  
Entkalkung  
Ontkalken  
Avkalkning



Rensing  
Afkalkning  
Kalkinpoisto  
Descalcificación  
Descalcificação

Programming  
Programmation  
Programmieren  
Programmeren  
Programmering



Programmering  
Programmering  
Ohjelmointi  
Programar  
Programação

Messages  
Messages  
Meldungen  
Meldingen  
Meddelanden



Meldinger  
Beskeder  
Viestit  
Mensajes  
Mensagens

Informazione  
Πληροφορίες  
Informace  
Informacja  
Informație



Информация  
Bilgi  
資料  
情報  
알림

Installazione  
Εγκατάσταση  
Instalace  
Instalacja  
Operare



Установка  
Yerleştirme  
安裝  
設置  
설치

Istruzione d'uso  
Χειρισμός  
Obsluha  
Instrukcja obsługi  
Instalare



Обслуживание  
Kullanım  
操作  
取り扱い  
취급

Pulizia  
Καθαρισμός  
Čištění  
Czyszczenie  
Curățare



Чистка  
Temizleme  
清洗  
洗淨  
청소

Decalcificazione  
Αφαλάτωση  
Odvápnění  
Odkamienianie  
Decalcarizare



Чистка от накипи  
Kireçten arındırma  
除垢  
데스케얼  
스케일 청소

Programmazione  
Προγραμματισμός λειτουργίας  
Programování  
Programowanie  
Programare



Программирование  
Programlama  
程式  
プログラミング  
프로그래밍

Messaggio  
Μηνύματα  
Zprávy  
Wiadomości  
Mesaje



Сообщения  
Mesajlar  
信息  
メッセージ  
메세지



700.403.347

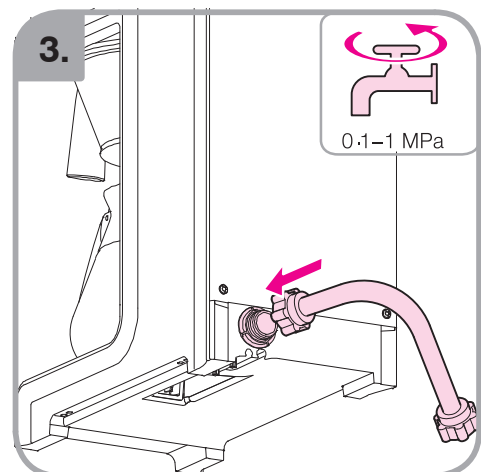
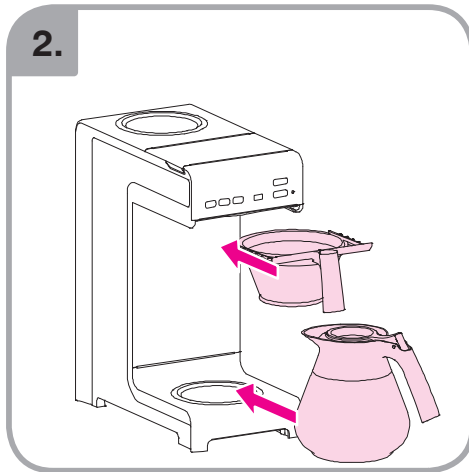

700.403.347

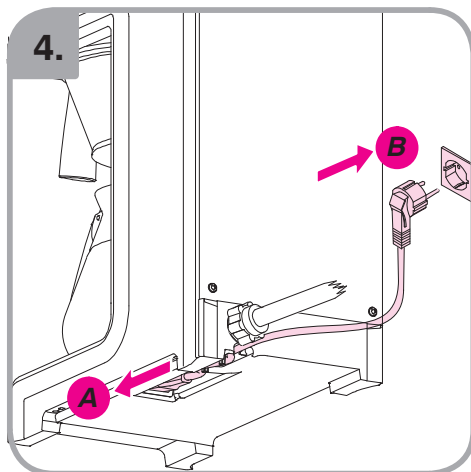

700.403.347

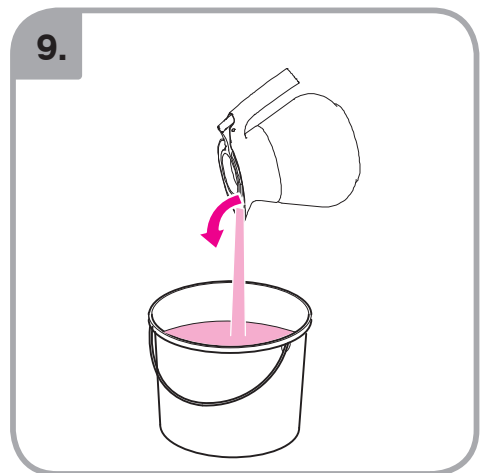
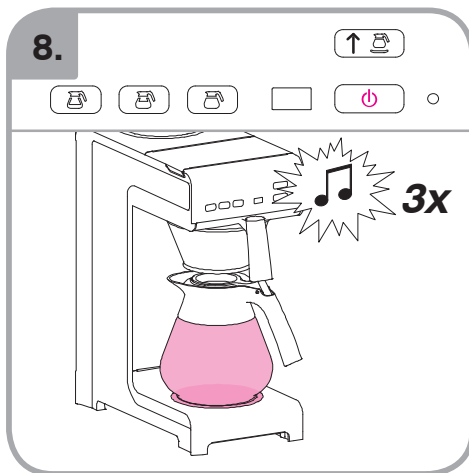
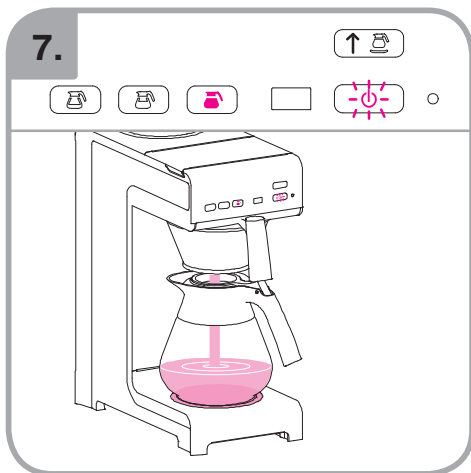
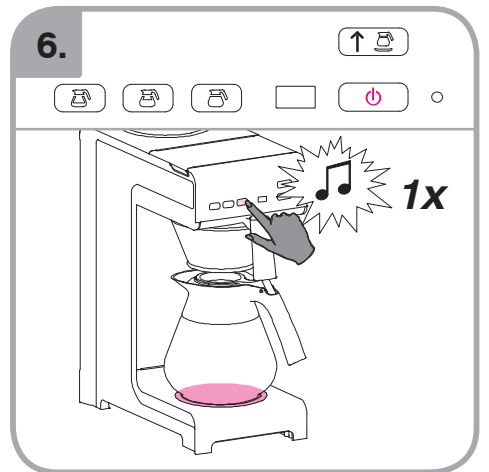
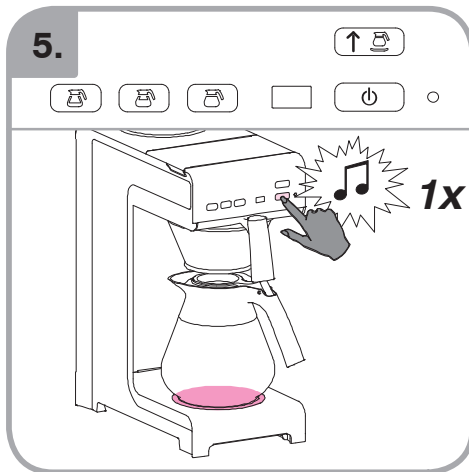





**1.**

≈ 40 g  
35-50 g/L

=1.6 L  
=0.8 L  
=0.4 L

**2.**

**3.**



**4.**

1x

**5.**

1x

**6.**



**7.**

3x

**8.**

**9.**



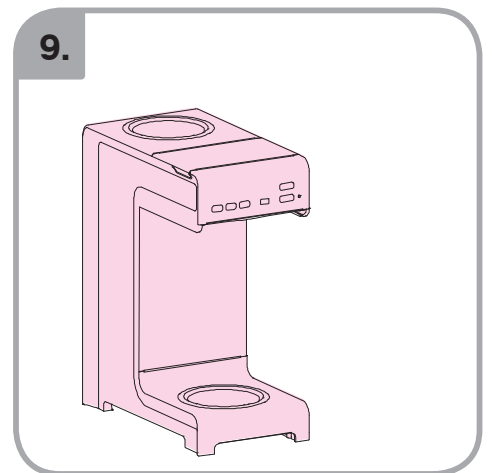
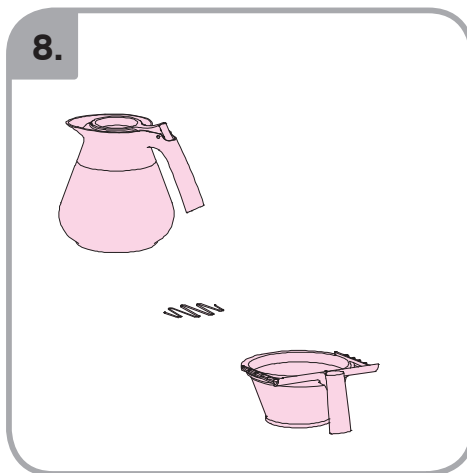
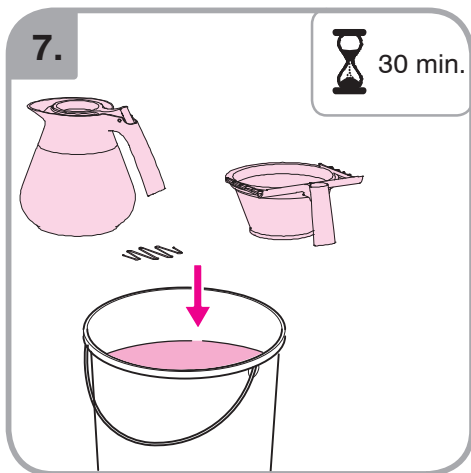
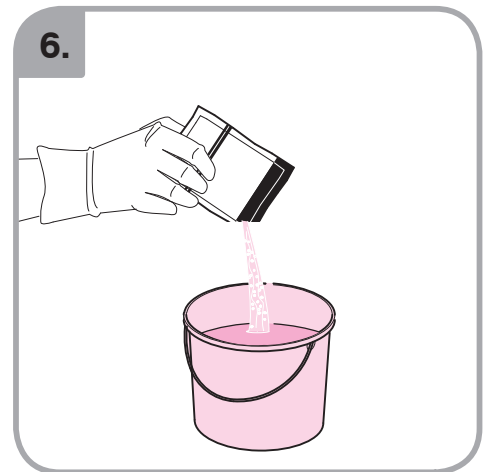
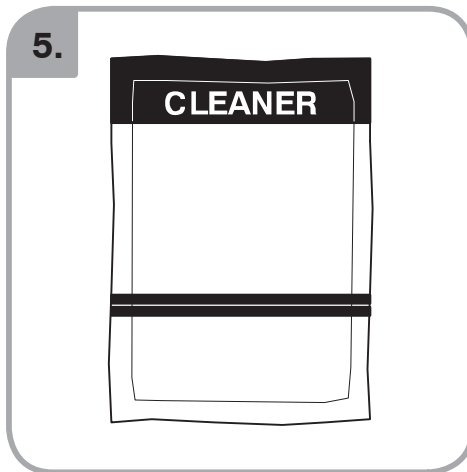
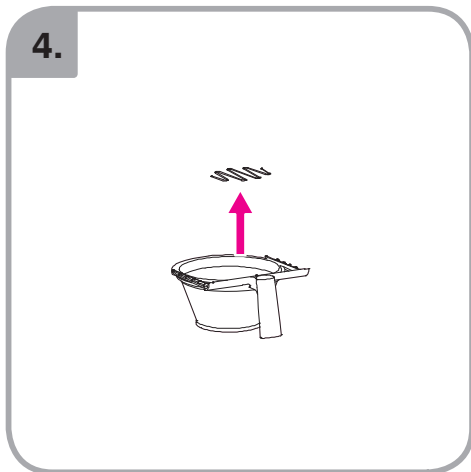
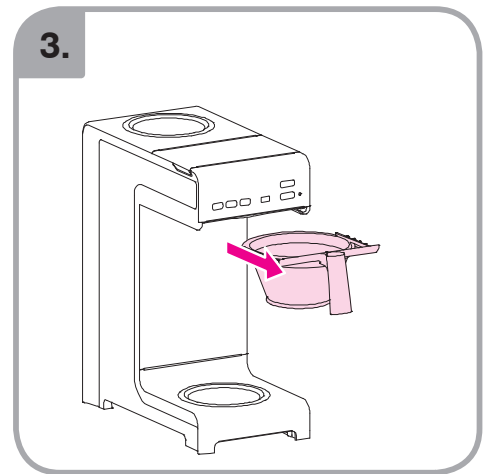
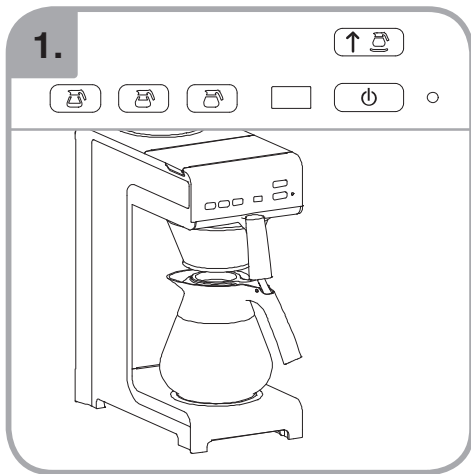





10.

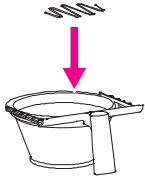

11.

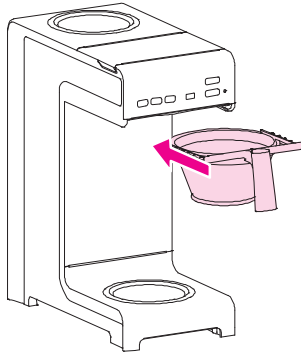

12.

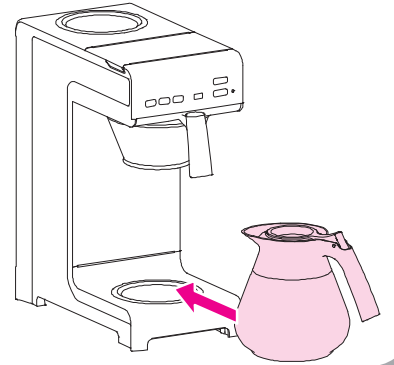

13.

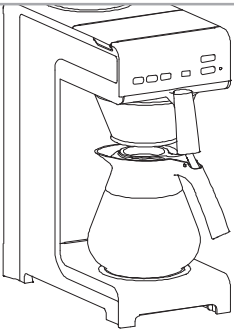

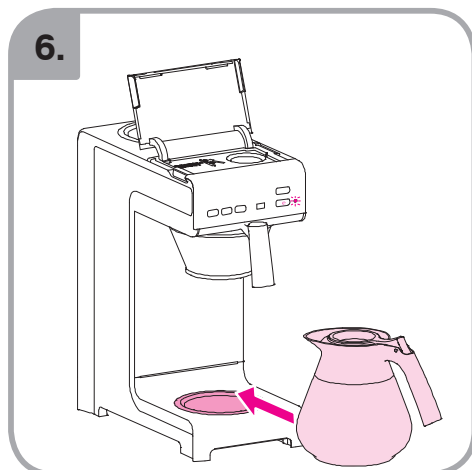
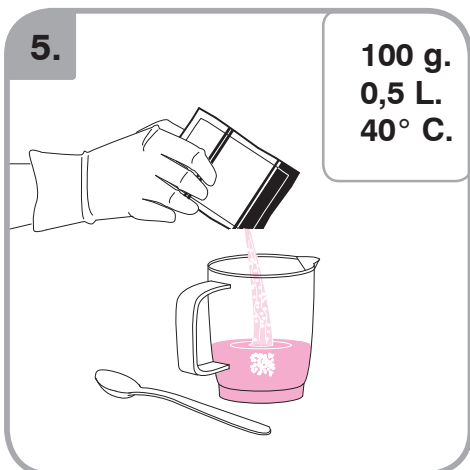
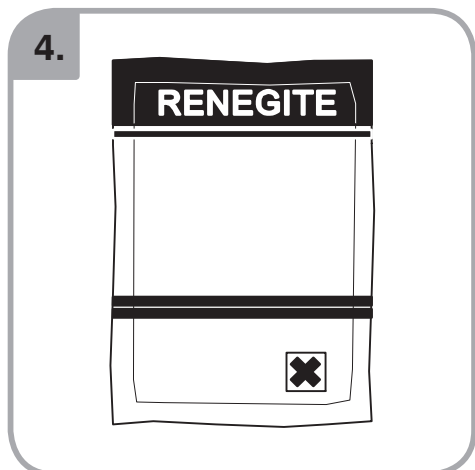
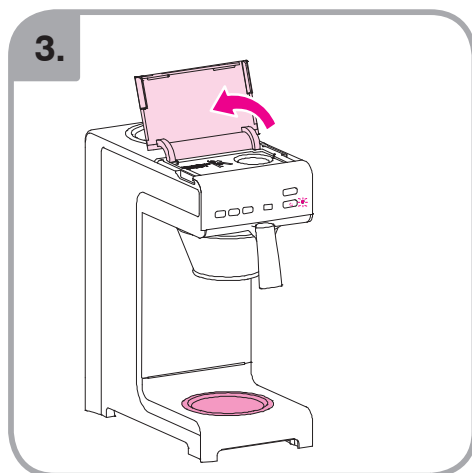
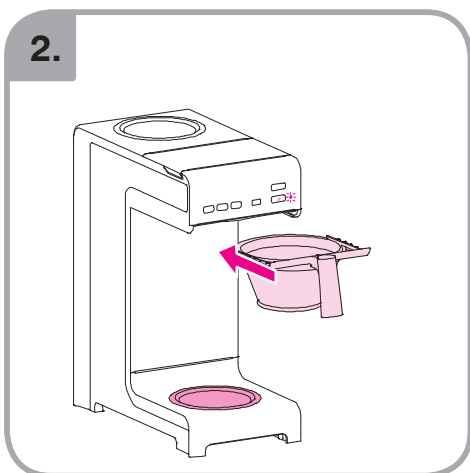
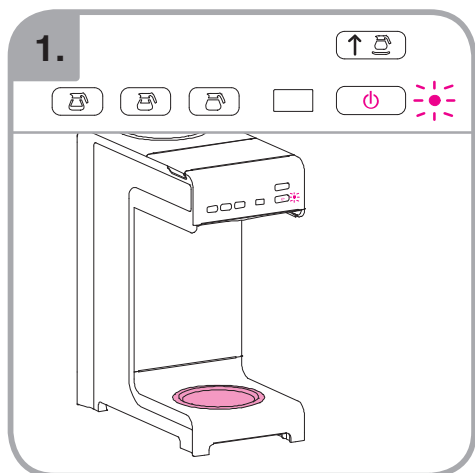

700.403.347

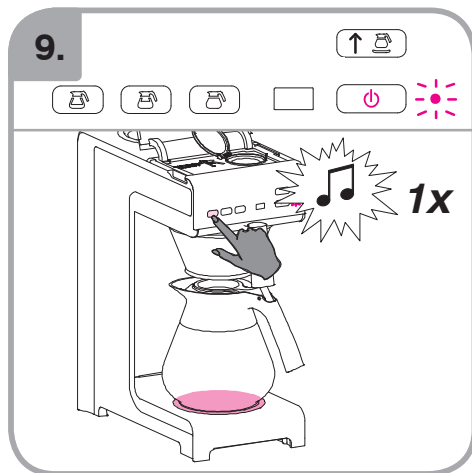
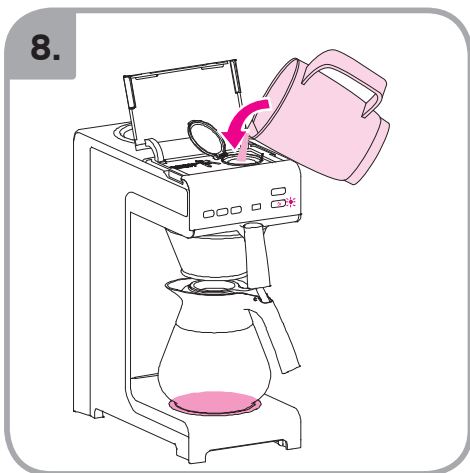
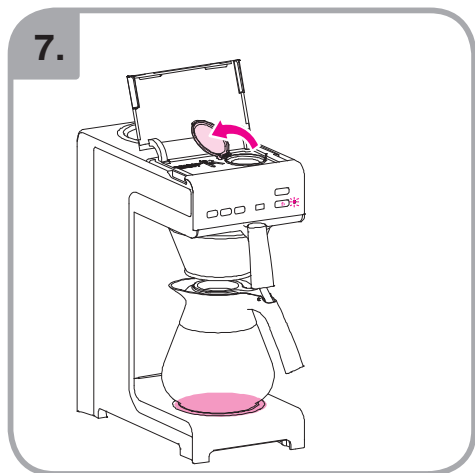

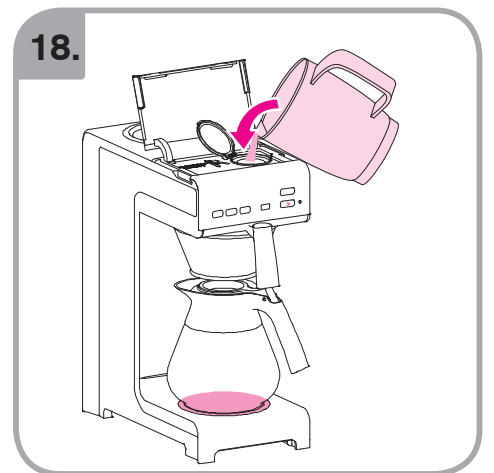
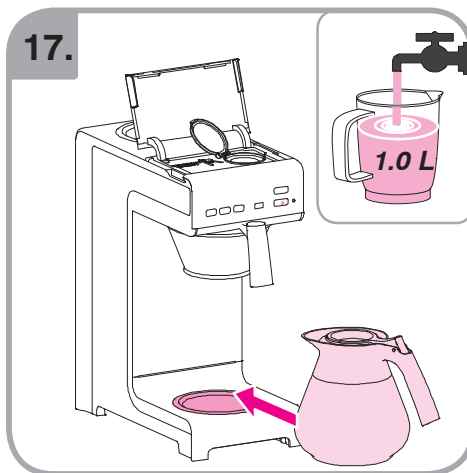
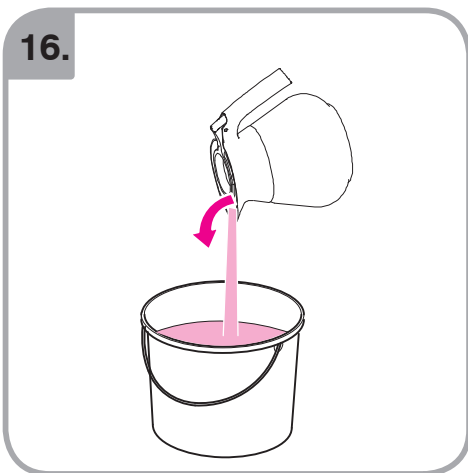
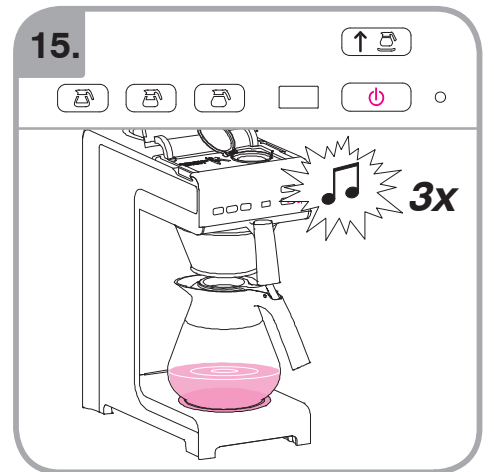
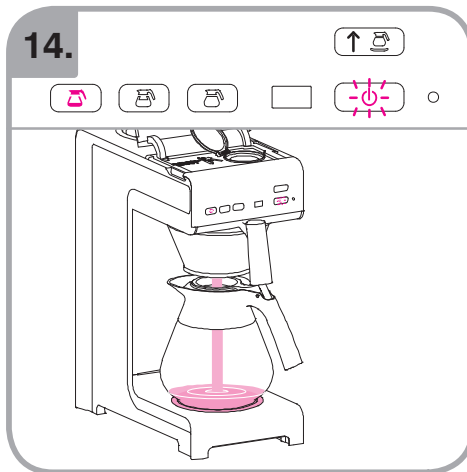
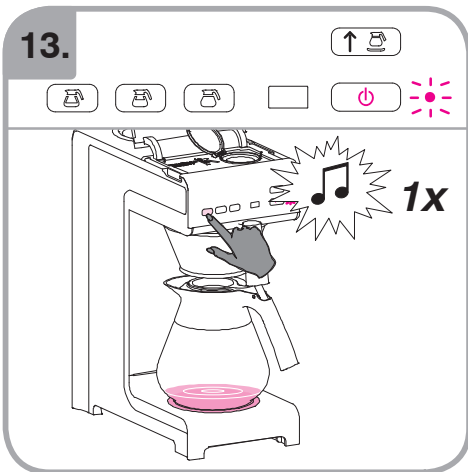
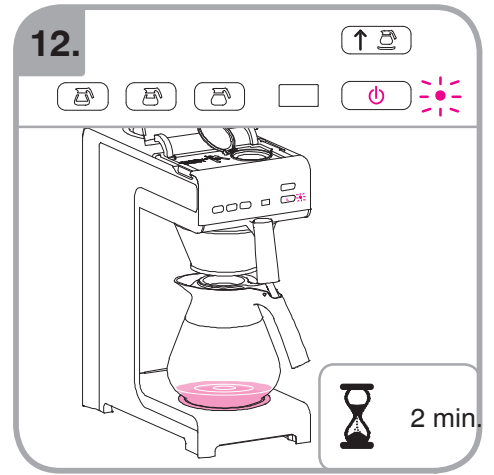
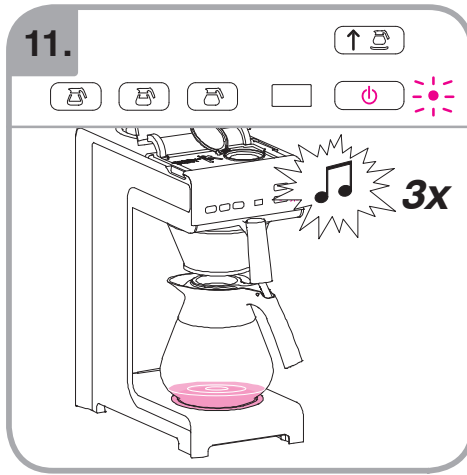
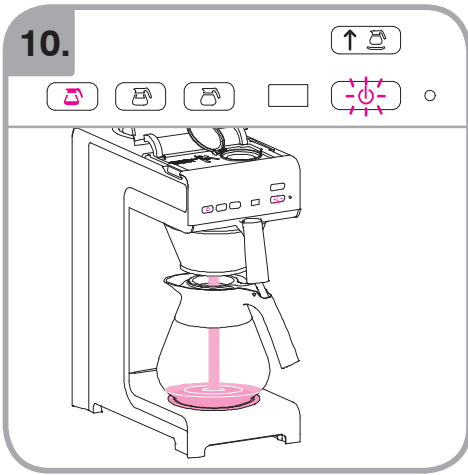

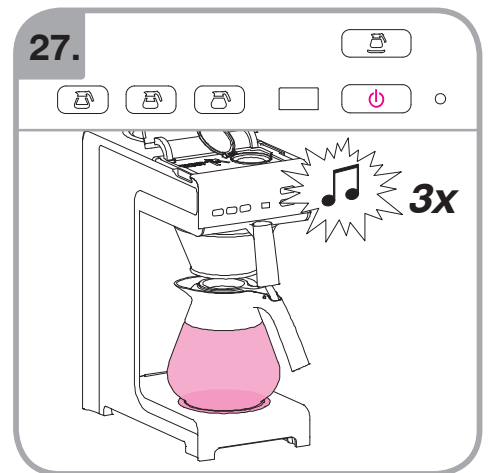
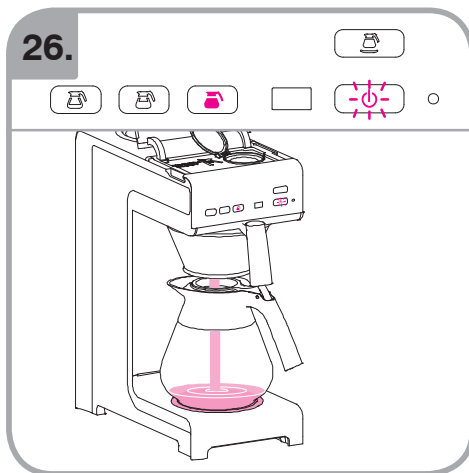
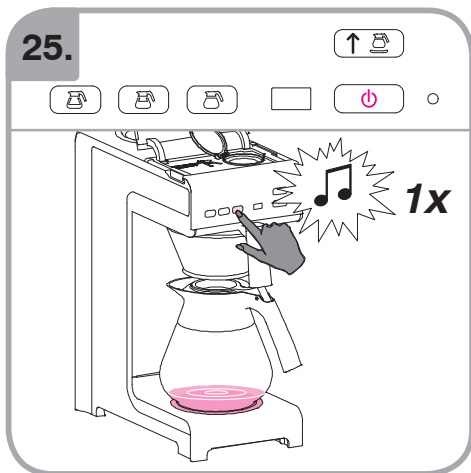
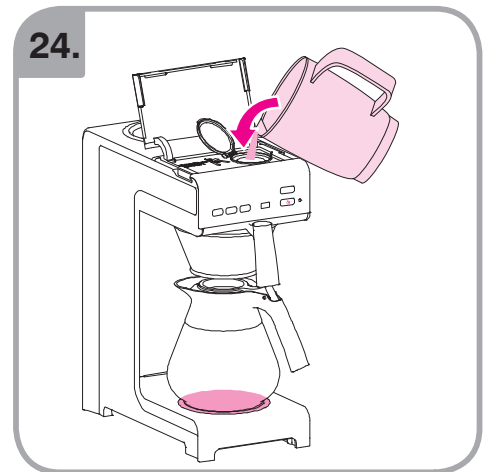
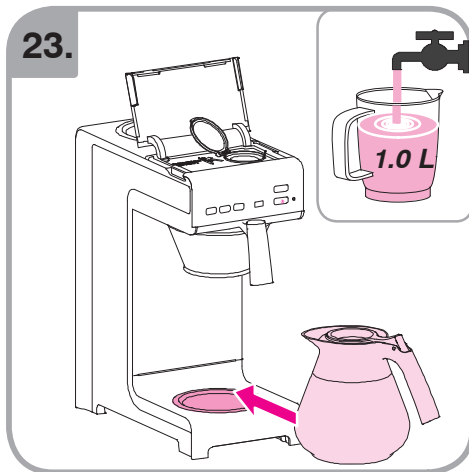
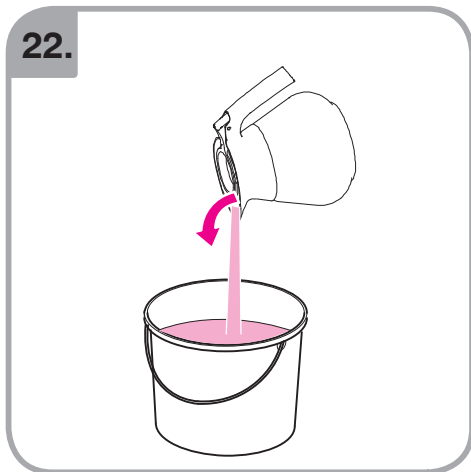
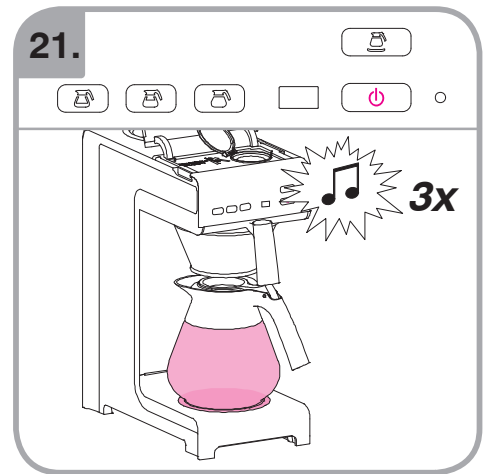
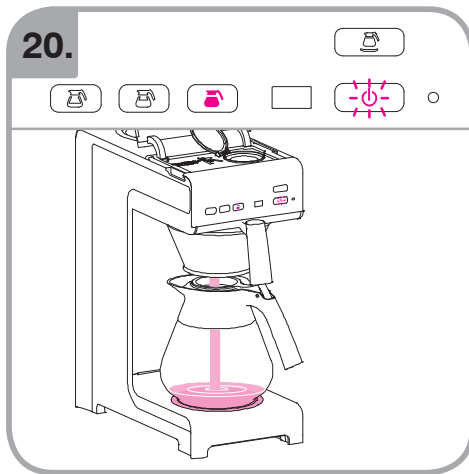
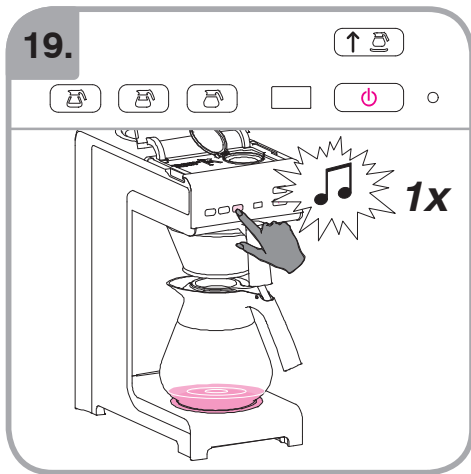



28.

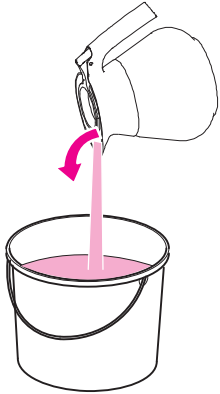

29.

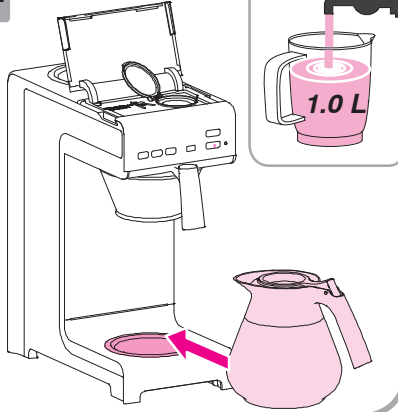

30.

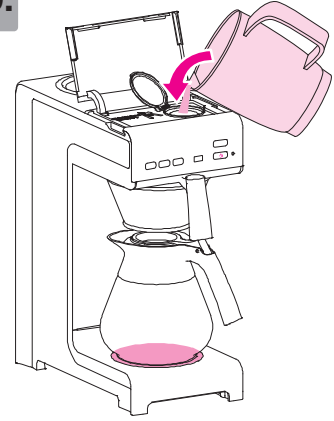

31.

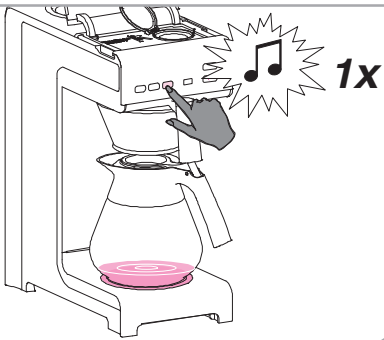

32.

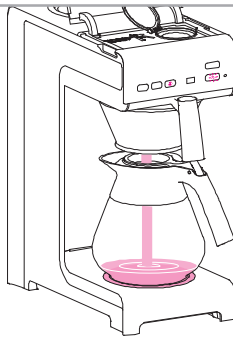

33.

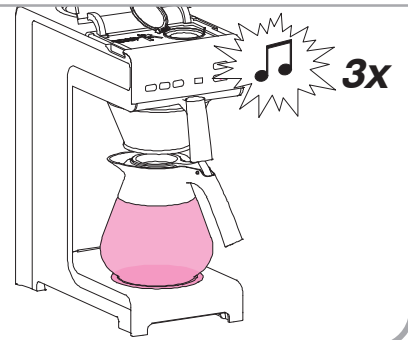

34.

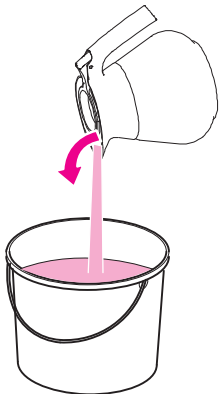

35.

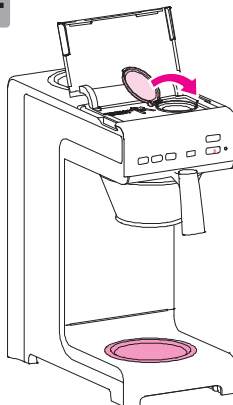

36.

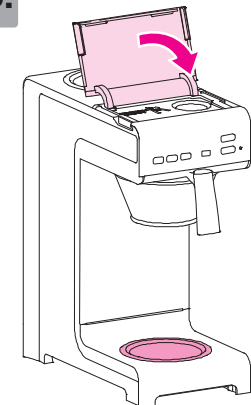

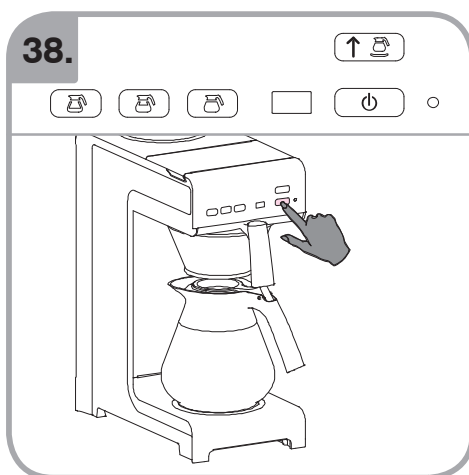
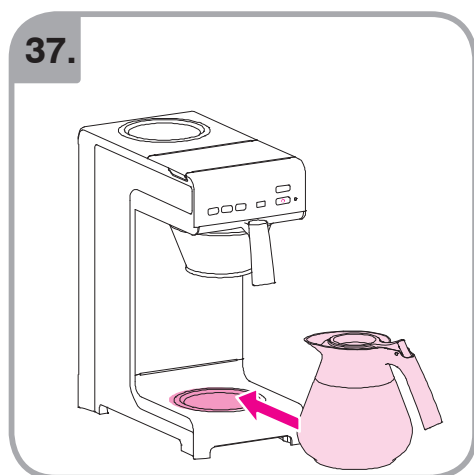



	□	▲	■	←	“ 580”	“x.x L”
English	Minimum value	Standard value	Maximum value	Confirm	Counter	Amount
Français	Valeur minimum	Valeur standard	Valeur maximum	Confirmer	Compteur	Quantité
Deutsch	Minimum Wert	Standard Wert	Maximum Wert	Sichern	Zähler	Fullmenge
Nederlands	Minimum waarde	Standaard waarde	maximum waarde	Bevestigen	Teller	Doseergrootte
Svenska	Minimum värde	Standard värde	Maximalt värde	Bekräfta	Räknare	Kvantitet
Norsk	Minimum verdi	Standard verdi	Maksimum verdi	Bekreft	Telleverk	Mengde
Dansk	Minimum værdi	Standard værdi	Maksimum værdi	Bekræft	Tæller	Mængde
Suomi	Minimi arvo	Oletusarvo	Maksimi arvo	Vahvista	Laskin	Kahvimäärä
Español	Valor mínimo	Valor estándar	Valor máximo	Confirmar	Contador	Dosificación
Português	Valor mínimo	Valor standard	Valor máximo	Confirmar	Contador	Quantidade
Italiano	Valore minimo	Valore standart	Valore massimo	Passo	Contatore	Quantità
Ελληνικά	Ελάχιστη τιμή	Θυσιολογική τιμή	Μέγιστη τιμή	Επιβεβαίωση	Μετρητής	Ποσότητα
Česky	Minimální hodnota	Standardní hodnota	Maximální hodnota	Potvrdit	Počítadlo	Množství
Polski	Minimalna wartość	Standardowa wartość	Maksymalna wartość	Potwierdzenie	Licznik	Doza
Română	Valoare minimă	Valoare standard	Valoare maximă	Confirmare	Contor	Canitate
Русский	Минимальный объем	Стандартный объем	Максимальный объем	Подтвердить	Счетчик	Порция
Türkçe	Minimum değer	Standart değer	Maksimum değer	Onayla	Sayaç	Miktar
中文	最小價值	標準價值	最大價值	計數器	確認	每壺份量
日本語	最小値	標準値	最大値	カウンタ	次のステップ	デカンター杯当りの最
한국	최소치	표준치	최대치	카운터	확인	더캔터당 량

**Reading the total counter**  
**Lecture du compteur total**  
**Ablesen des Gesamtzählers**  
**Uitlezen totaal teller**  
**Avläsning av totalräkneverket**

**Avlesning av totaltelleren**  
**Aflæsning af samlede tæller**  
**Kokonaismäärälaskurin lukeminen**  
**Lectura del contador total**  
**Leitura do contador total**

**Letture del contatore totale**  
**Ανάγωση συνολικού μετρητή**  
**Uđaj o celkovém stavu počítadla**  
**Odczyt całkowitego licznika**  
**Citirea contorului total**

**СЧИТЫВАНИЕ ИТОГОВОГО КОЛИЧЕСТВА**  
**Toplam sayaç okuma**  
 读取总计计数器  
 合計カウンタの読み取り  
 카운터 표시

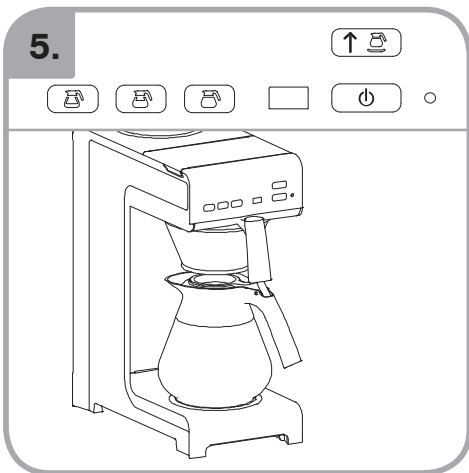
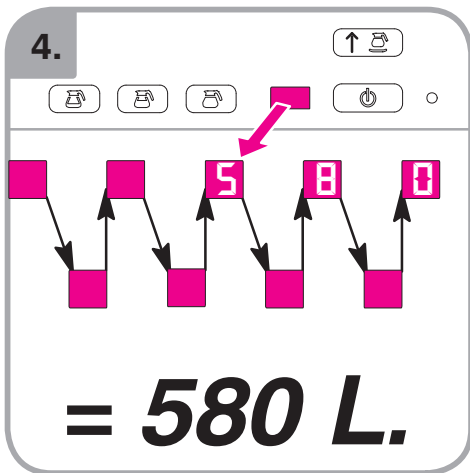
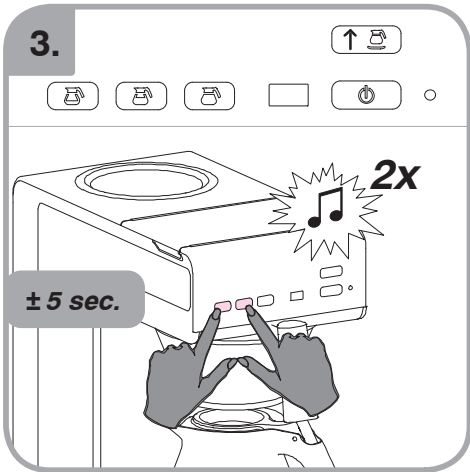
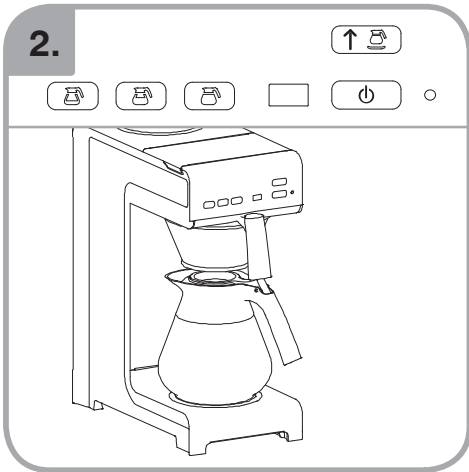
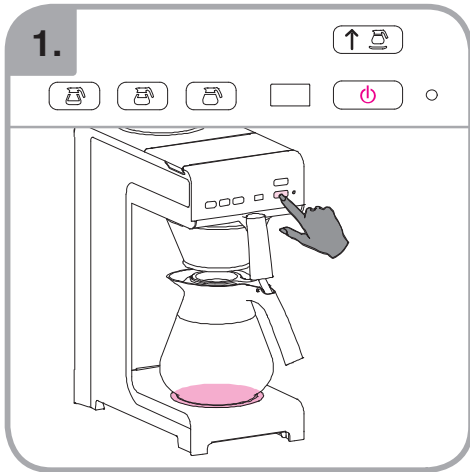



Setting the water quantity  
 Réglage de la quantité d'eau  
 Einstellung der Wassermenge  
 Waterhoeveelheid instellen  
 Inställning av vattenmängden

Innstilling av vannmengden  
 Indstilling af vandmængden  
 Veden määrän säätö  
 Ajuste de la cantidad de agua  
 Configuração da quantidade de água

Regolazione della quantità d'acqua  
 Ρύθμιση ποσότητας νερού  
 Nastavení množství vody  
 Ustawienie jakości wody  
 Setarea cantității apei

Установка количества воды  
 Suurikvanti ayari  
 水の品質の設定  
 수량 설정

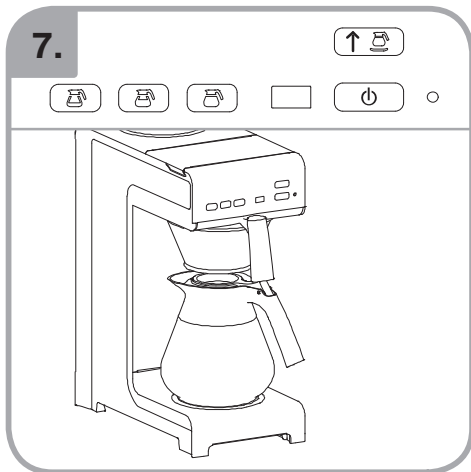
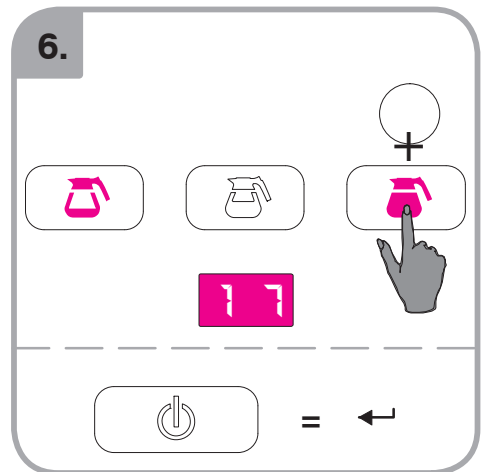
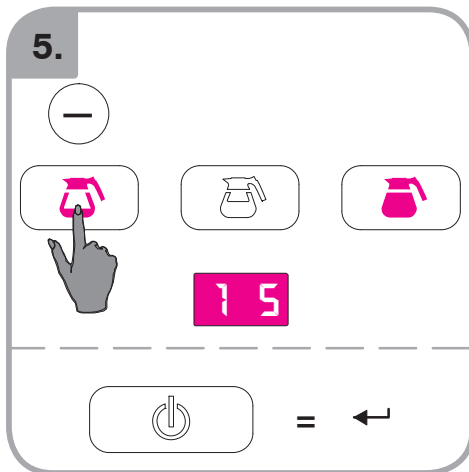
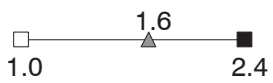
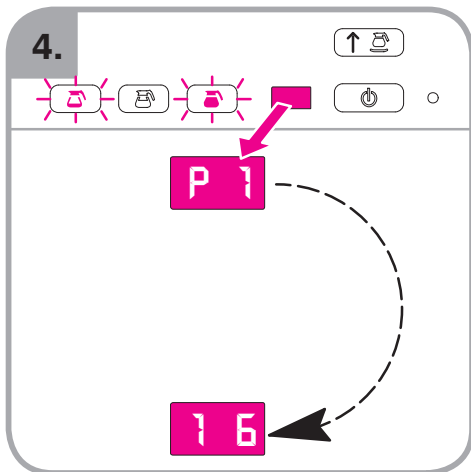
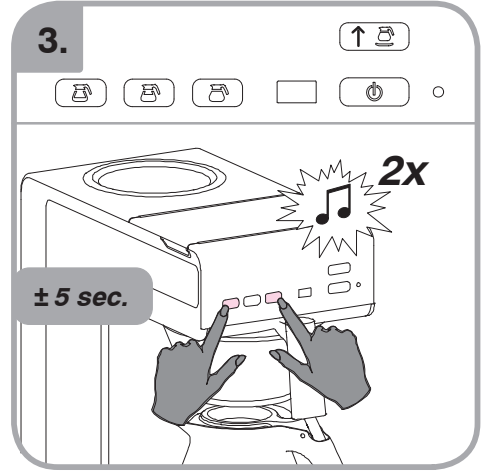
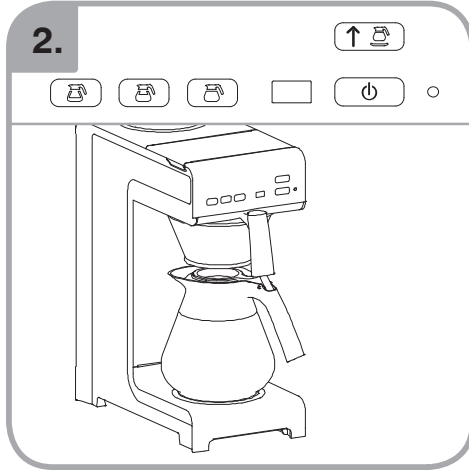
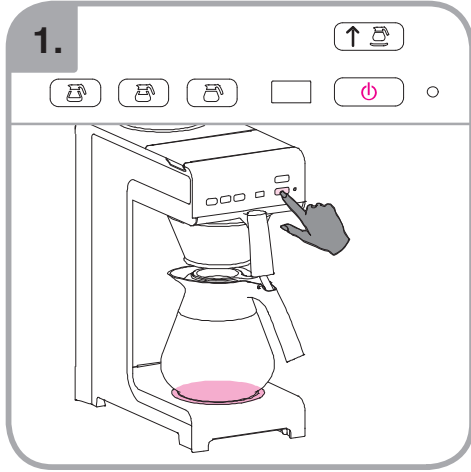

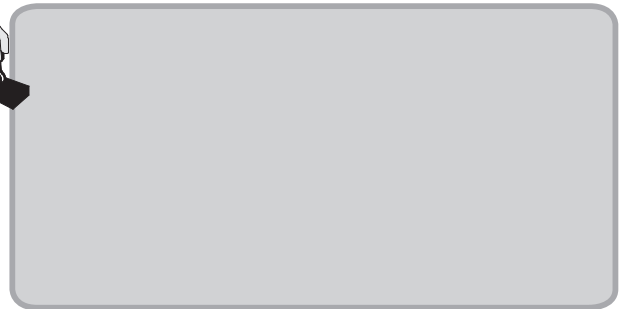
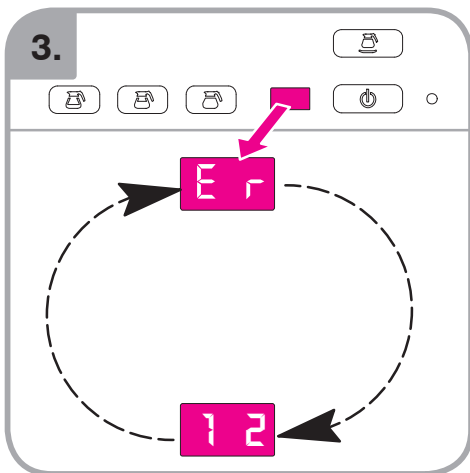
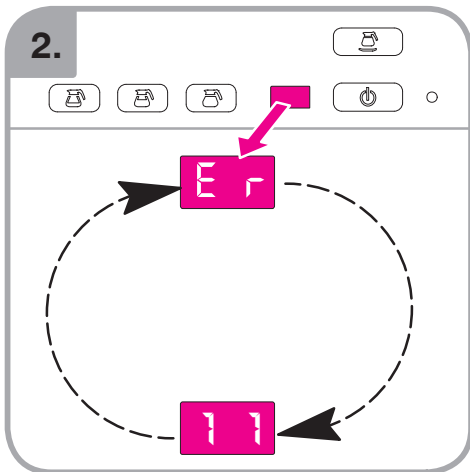
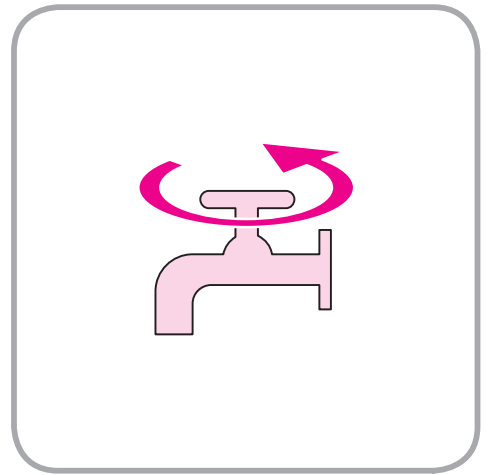
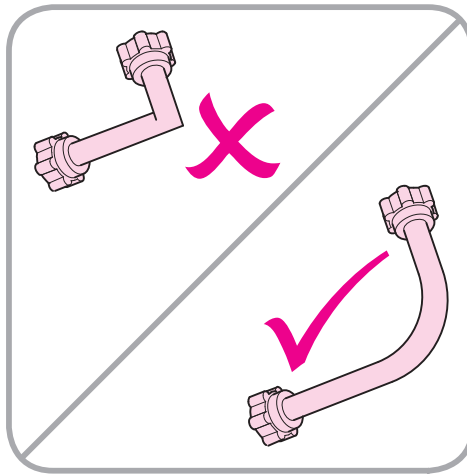
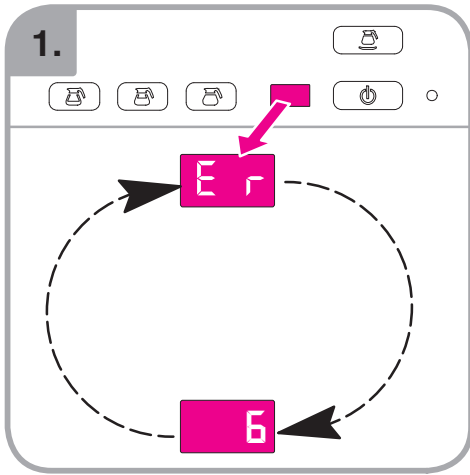

# Matic

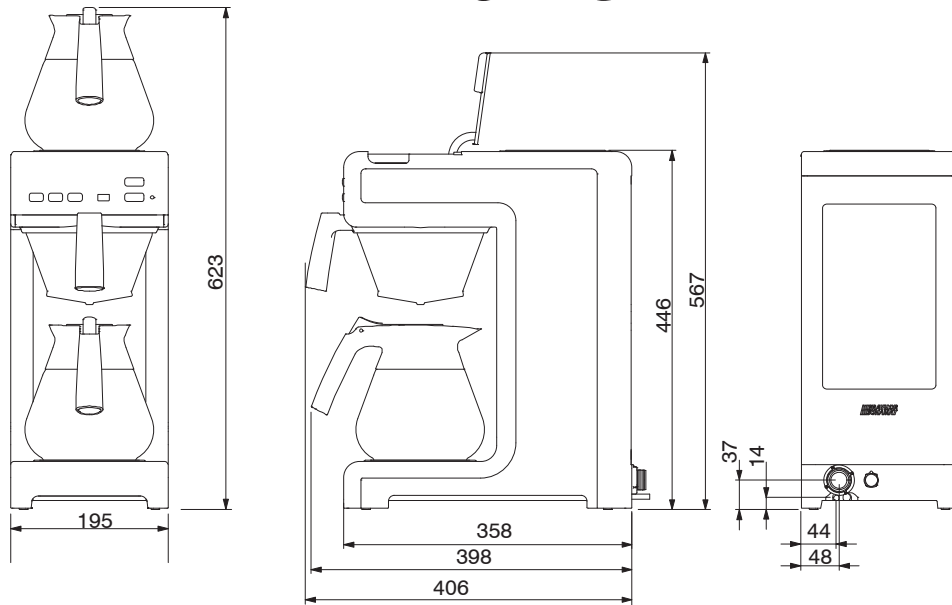

# Matic Twin

