

ERST-HOLZ®

WWW.ERST-HOLZ.DE

Artikel-Nr.: 90.80-03/110

Datum: 20.03.2024

Seite 01 von 05

Montageanleitung

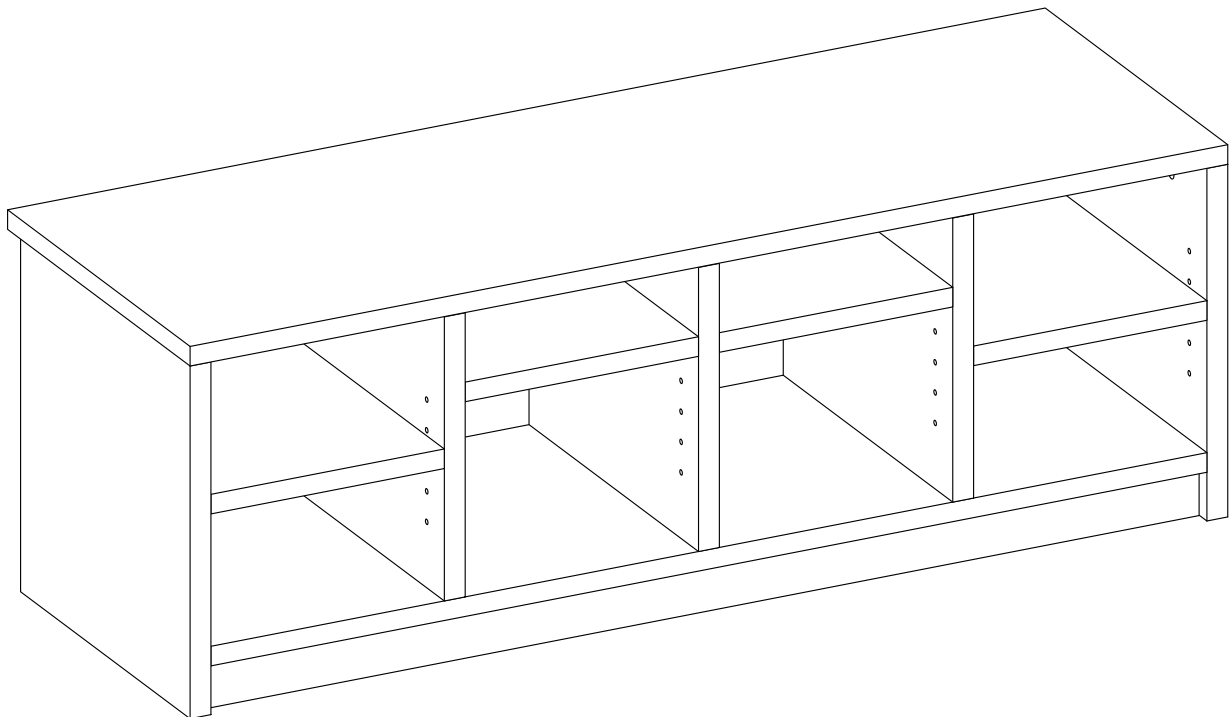

ERST-HOLZ® - die Marke für gute Holzprodukte

Steinhaus Handelsgesellschaft mbH & Co KG - Schauerödstr. 21 - 94152 Neuhaus - Tel.: 0 8503 924540

E-Mail: auftrag@erst-holz.de

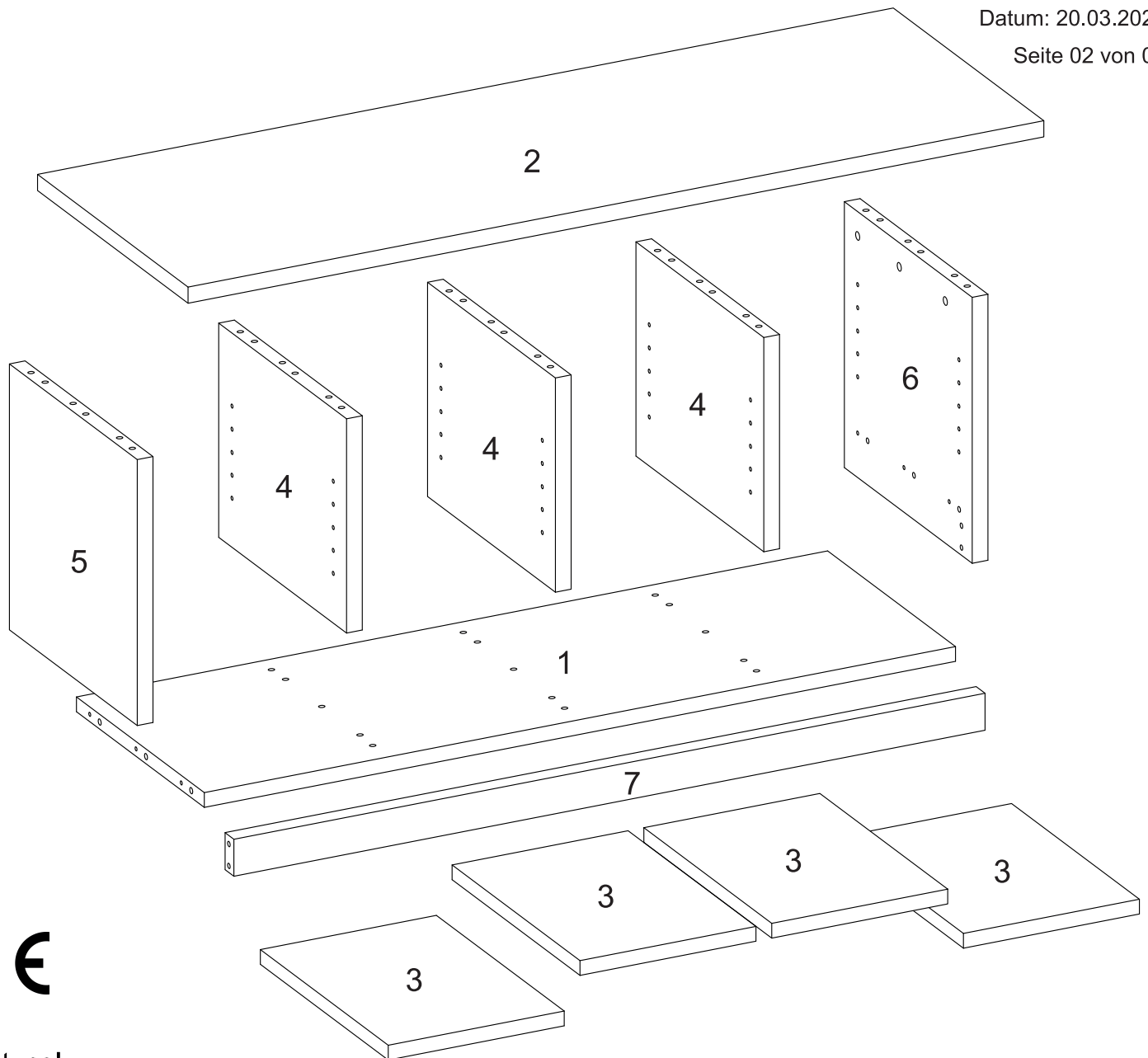





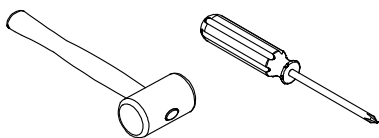

Achtung!
 Bevor Sie die Schrauben, Dübel, Muttern in die dafür vorgesehenen Löcher stecken, prüfen Sie, ob sich gegebenenfalls noch Holzspäne in den Löchern befinden.

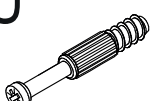
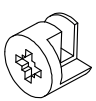
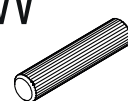
Sie benötigen zum Aufbau:



Teile-Nr.	Bezeichnung	Anzahl
1	Bodenplatte	1
2	Deckplatte	1
3	Fach	4
4	Mittelseiten	3
5	linke Seite	1
6	rechte Seite	1
7	Sockel	1

U 6,3x44mm  21 Stück	V Ø15x12mm  21 Stück	W Ø8x35mm  34 Stück	AN Ø7x50mm  6 Stück	GD  1 Stück	GL  5 Stück	IL  16 Stück	IM  4 Stück
--	---	--	--	---	---	--	---

1

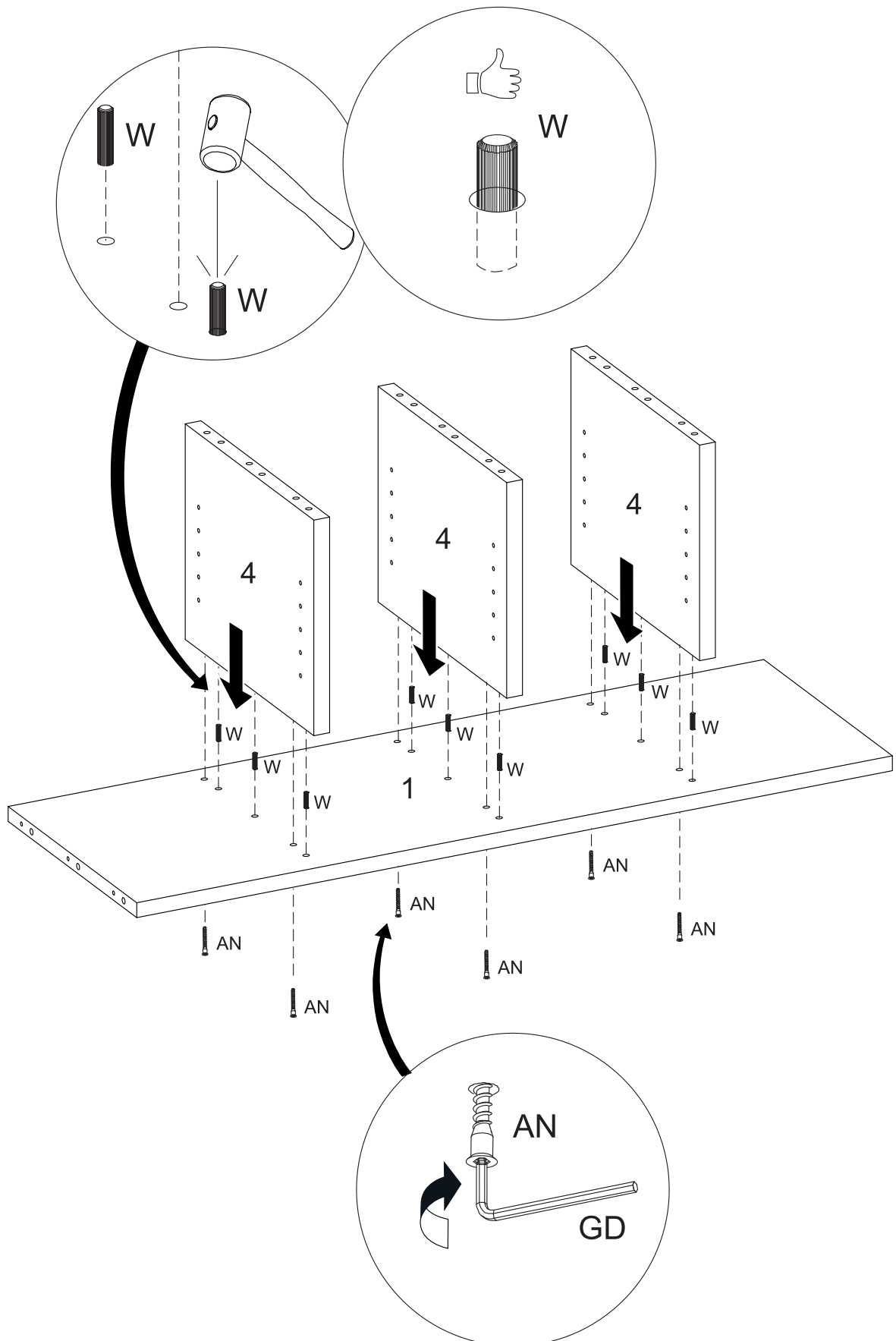

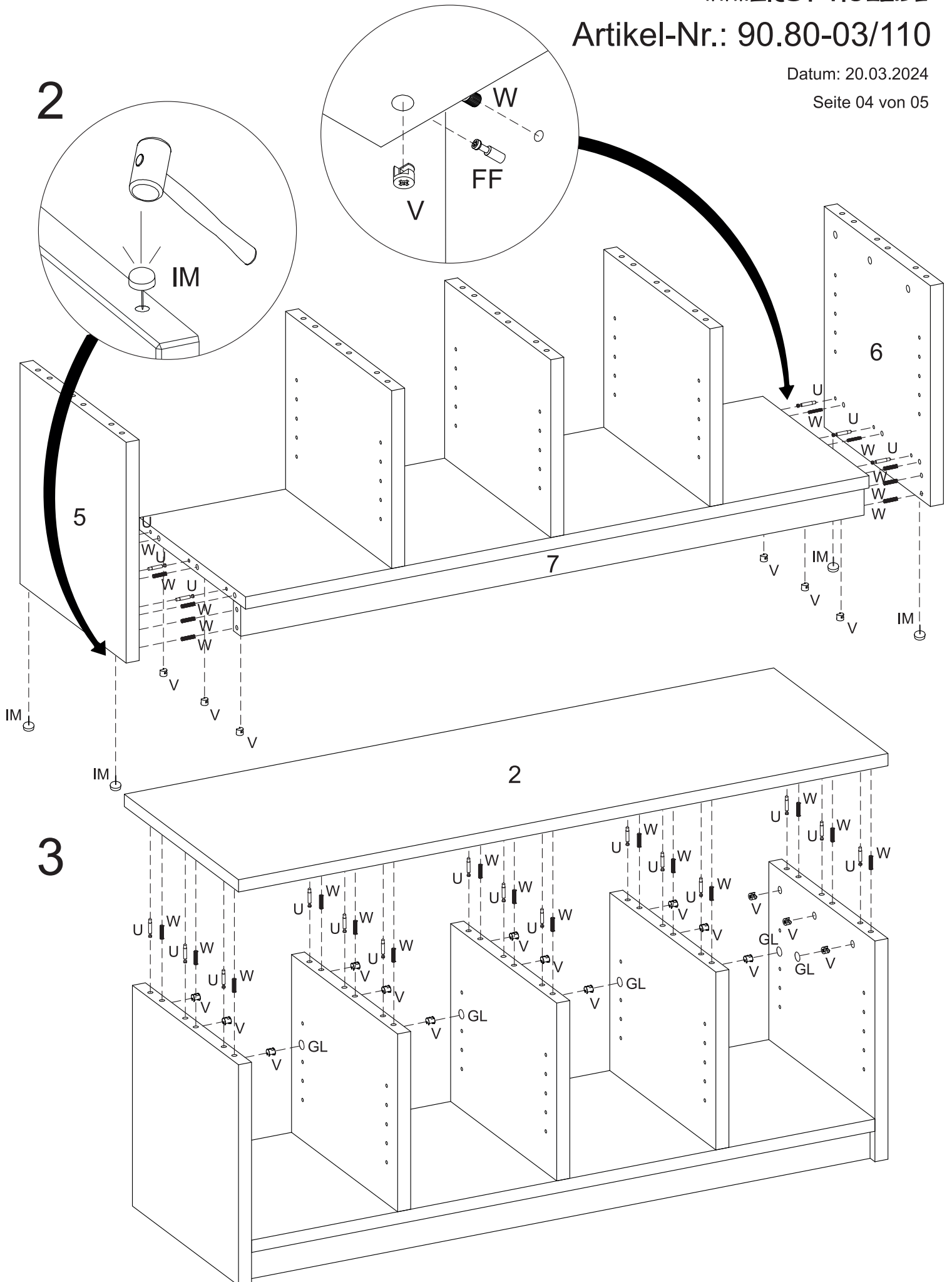

4

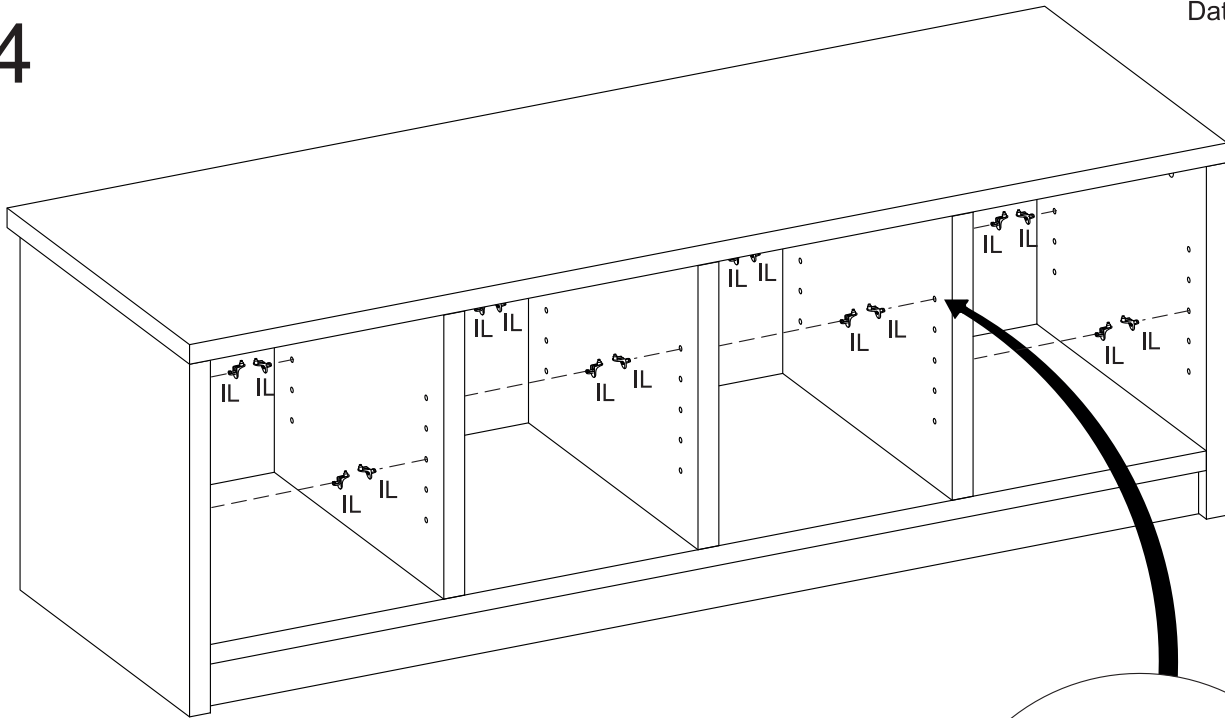

5

