



ERST-HOLZ[®]

WWW.ERST-HOLZ.DE

Artikel-Nr.: 60.83-10

Datum: 17.11.2022

Seite 01 von 04

Montageanleitung

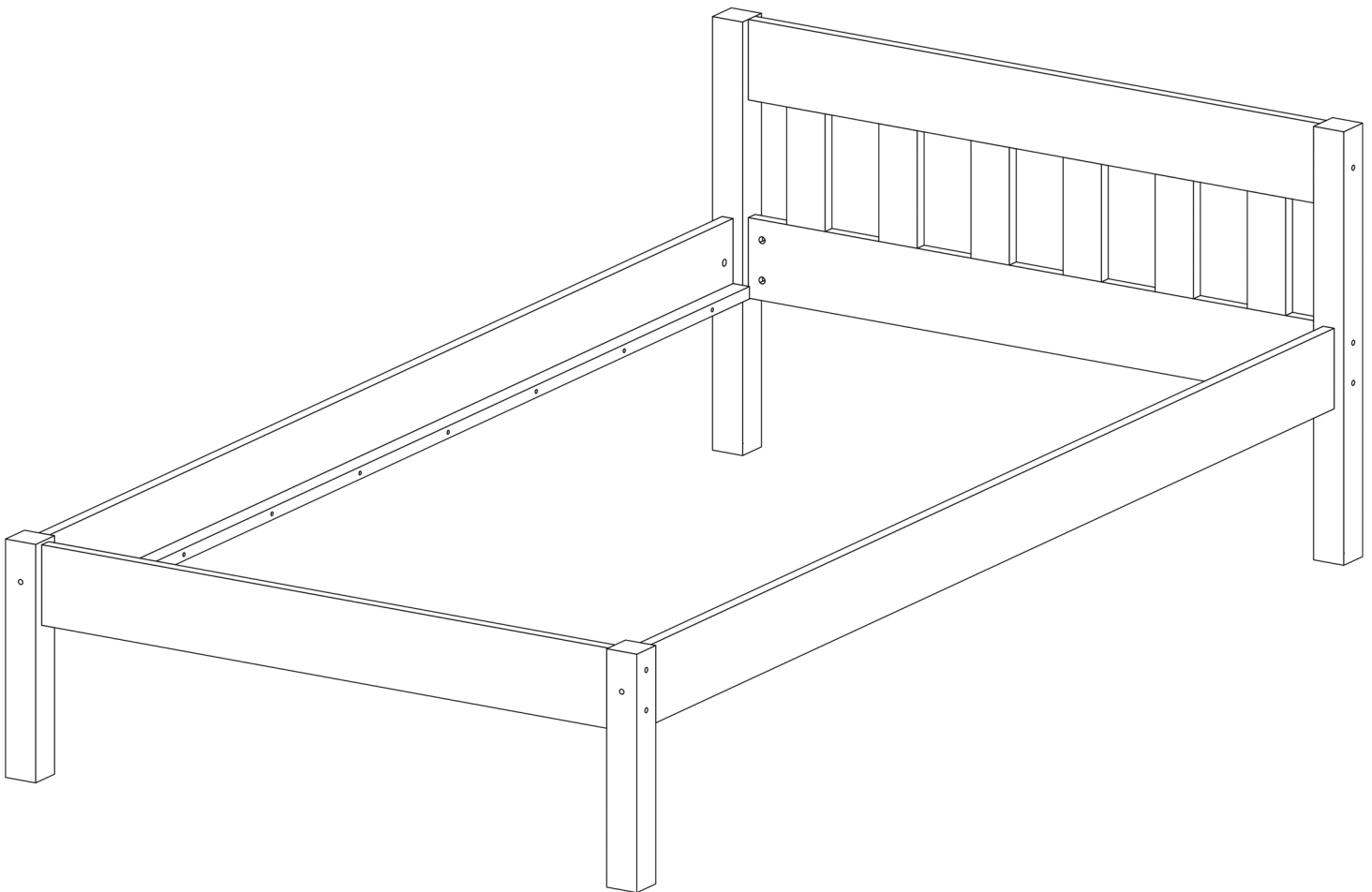

ERST-HOLZ[®] - die Marke für gute Holzprodukte

Steinhaus Handelsgesellschaft mbH & Co KG - Schauerödstr. 21 - 94152 Neuhaus - Tel.: 0 8503 924540

E-Mail: auftrag@erst-holz.de

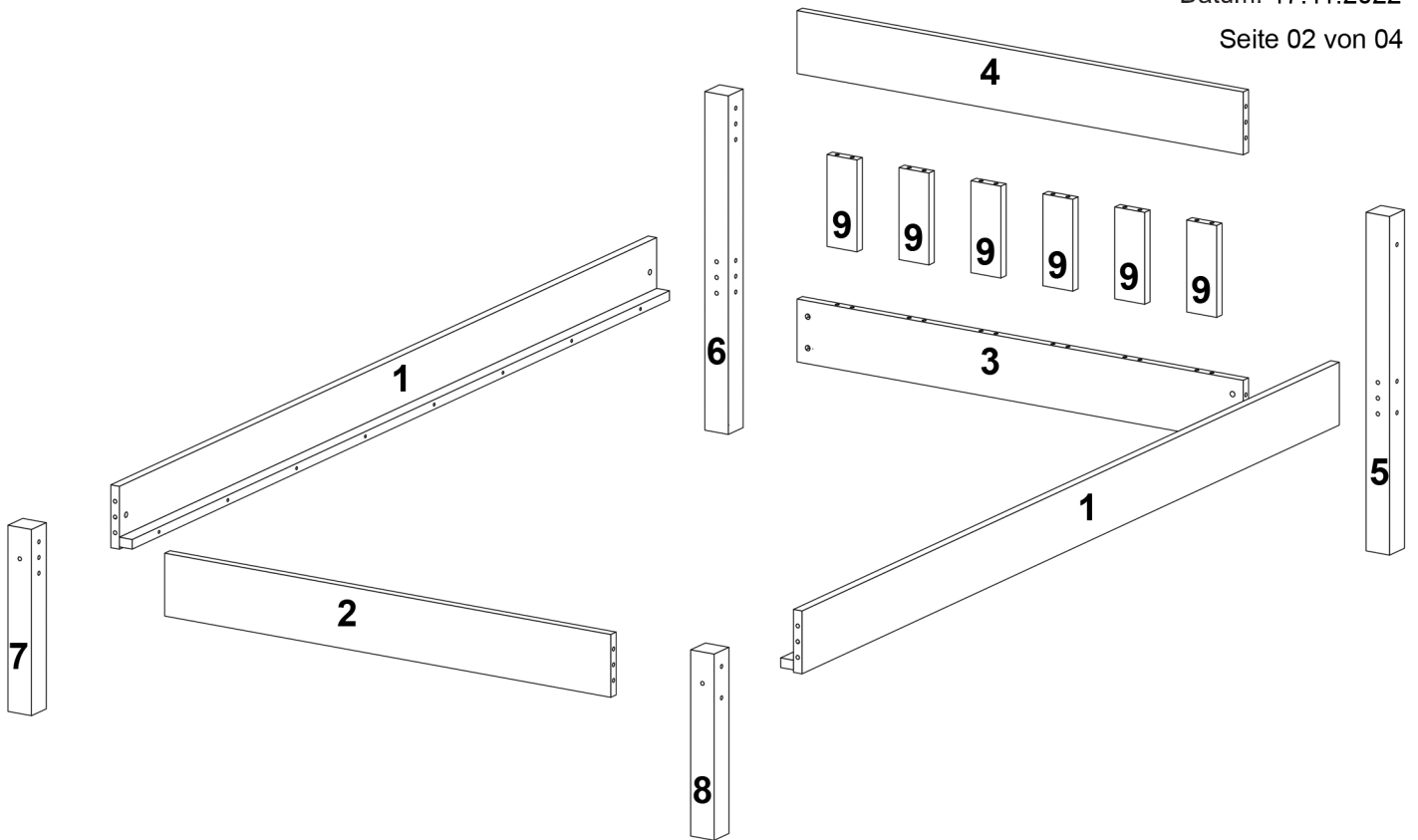





Achtung!
 Bevor Sie die Schrauben, Dübel, Muttern in die dafür vorgesehenen Löcher stecken, prüfen Sie, ob sich gegebenenfalls noch Holzspäne in den Löchern befinden.

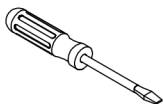
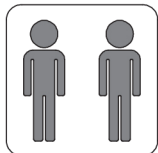

Sie benötigen zum Aufbau:

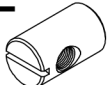

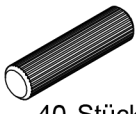
Teile-Nr.	Bezeichnung	Anzahl
1	Seitenteile	2
2	Fußteilleiste	1
3	Kopfteilleiste unten	1
4	Kopfteilleiste oben	1
5	Pfosten Kopfteil rechts	1
6	Pfosten Kopfteil links	1
7	Pfosten Fußteil links	1
8	Pfosten Fußteil rechts	1
9	Sprossen	6

E  14 Stück	K  1 Stück	P Ø8x40mm  40 Stück	BC M6x90mm  14 Stück
--	--	---	--

1

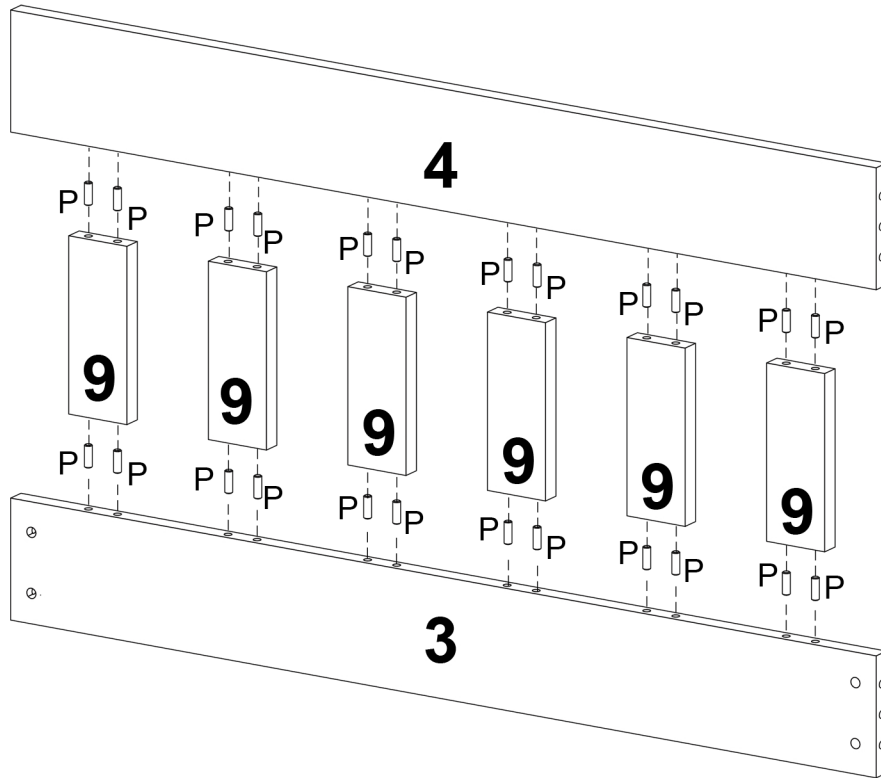

2

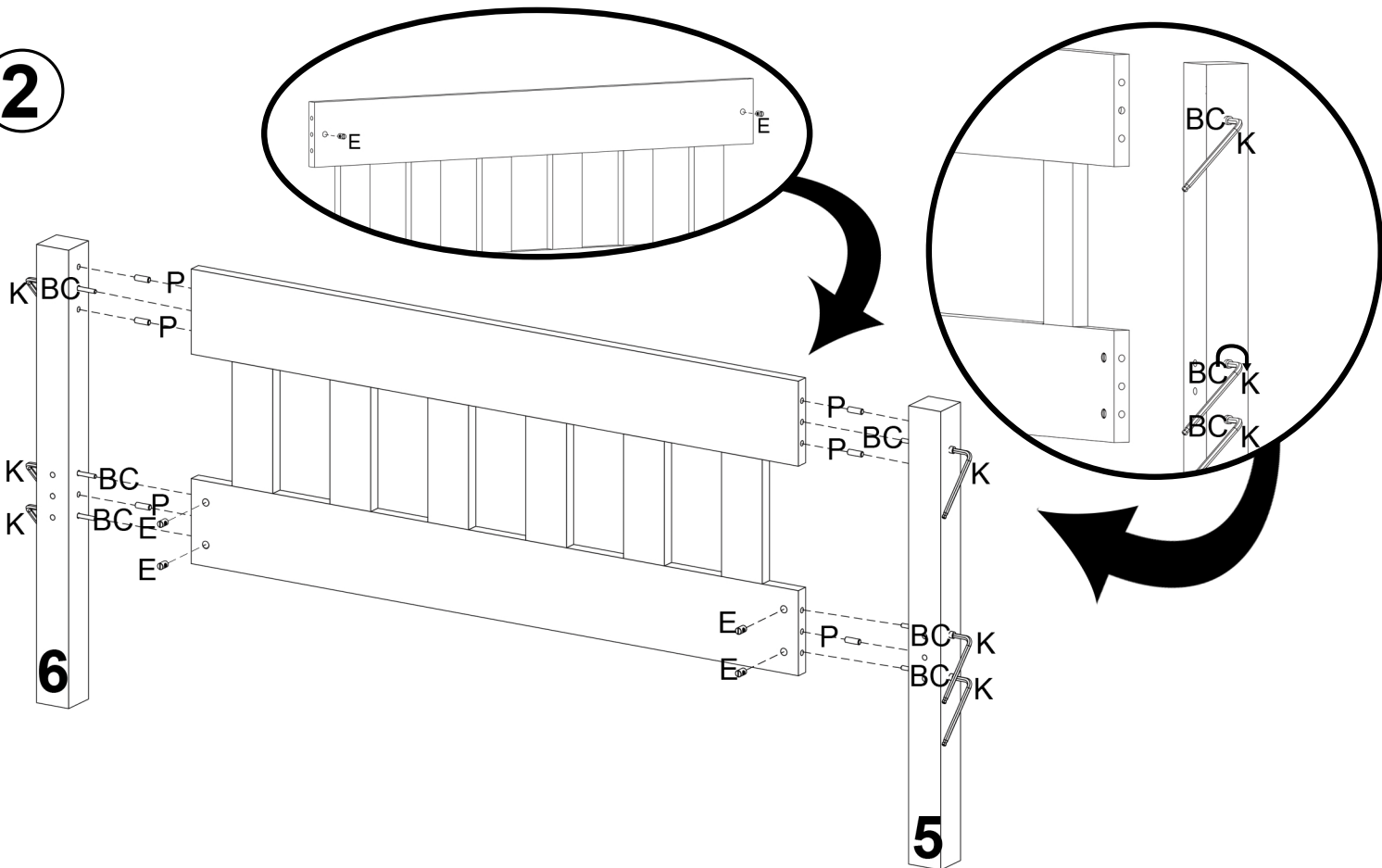

3

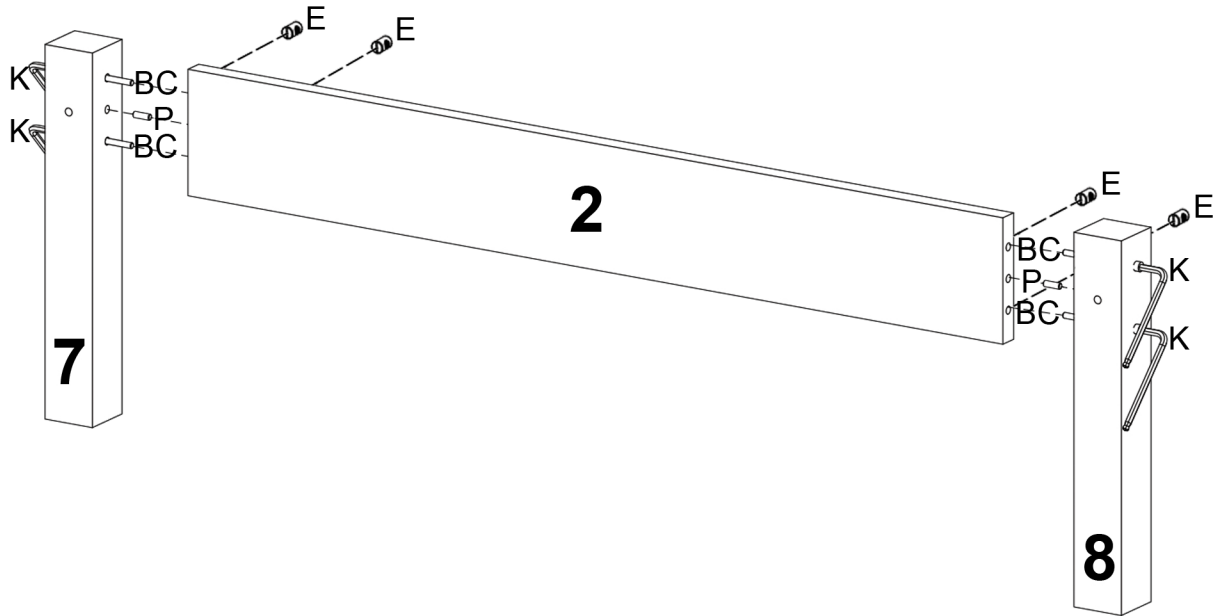

4

