

Aufbauanleitung

**Salzwand Komplettbausatz WE5
für Mehrfachmodule**

**von
Pramodan & Dinesh**

Version 1.1

Maße für den Elektroanschluß

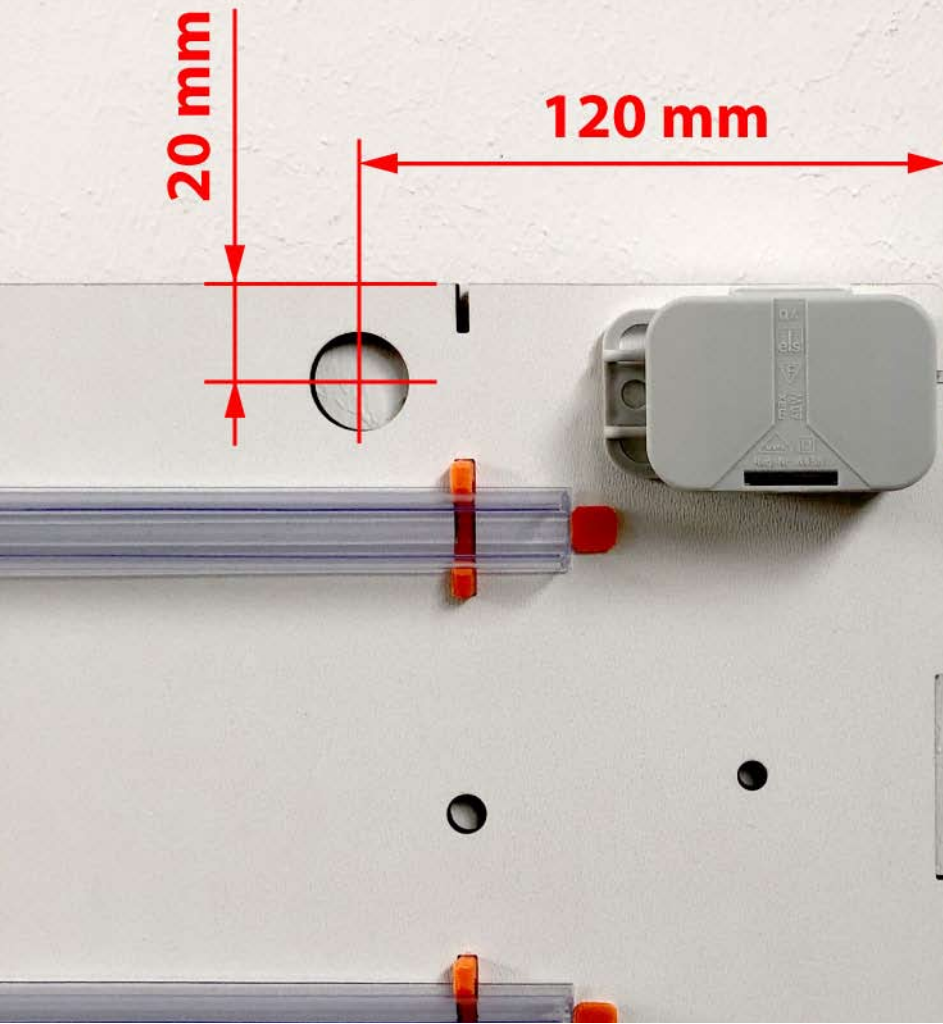

Benötigte Werkzeuge

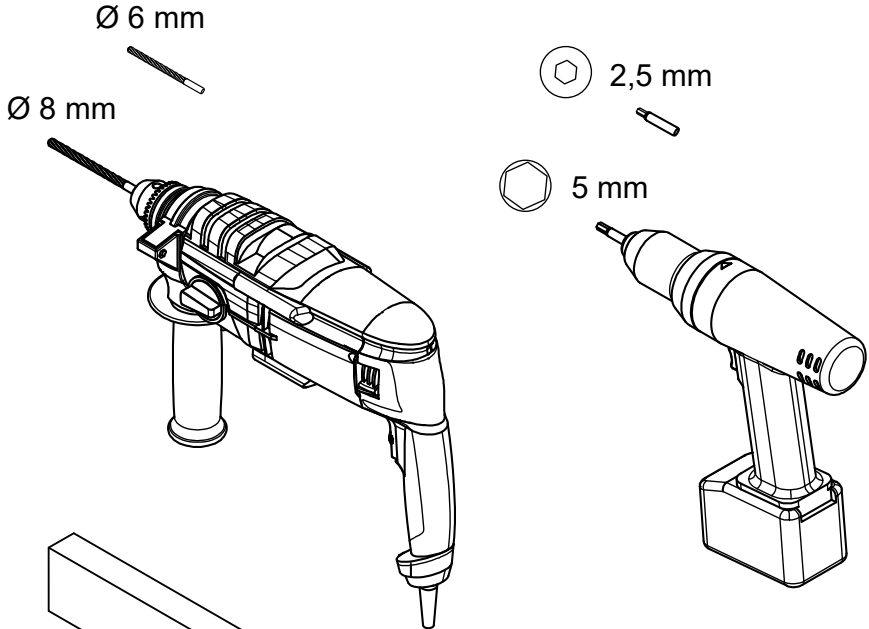

- Bohrmaschine mit 6- und 8-mm-Bohrer
- Akku-Schrauber mit Innensechskant-Bit 2,5 mm und 5 mm
- Schraubenzieher
- Abisolierwerkzeug
- Hammer
- Bleistift und Wasserwaage

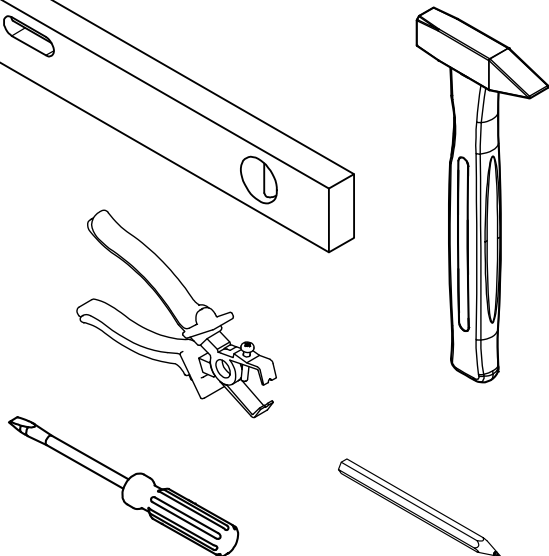

Akku-Schrauber: schwächste Stufe!



 2,5 mm

Salzziegel gut festhalten!

**Vor Erreichen der Endtiefe
langsamer drehen!**





Ø 6 mm



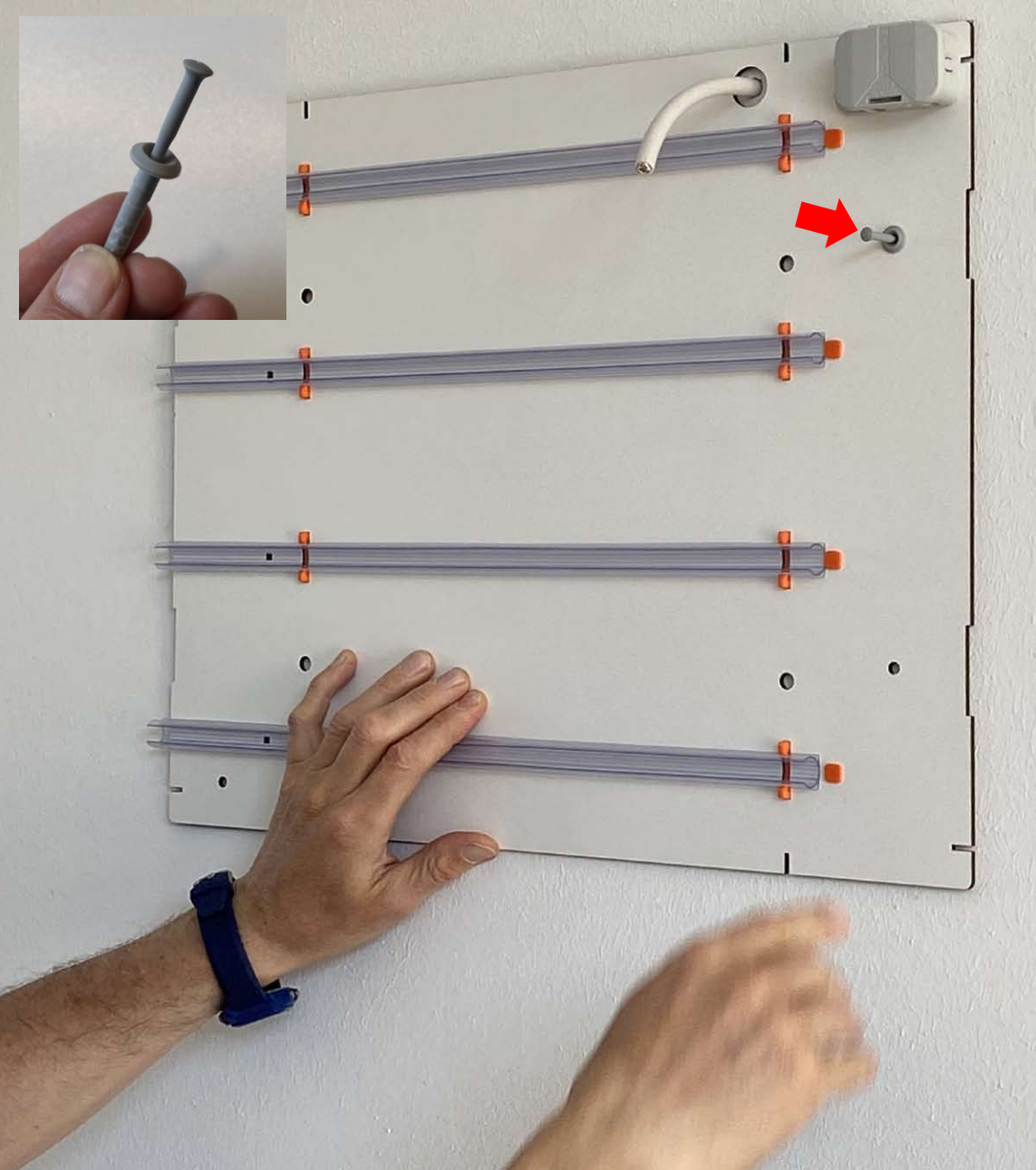

Schlagdübel einsetzen, Nagel nur leicht einschlagen, bis Dübel greift.



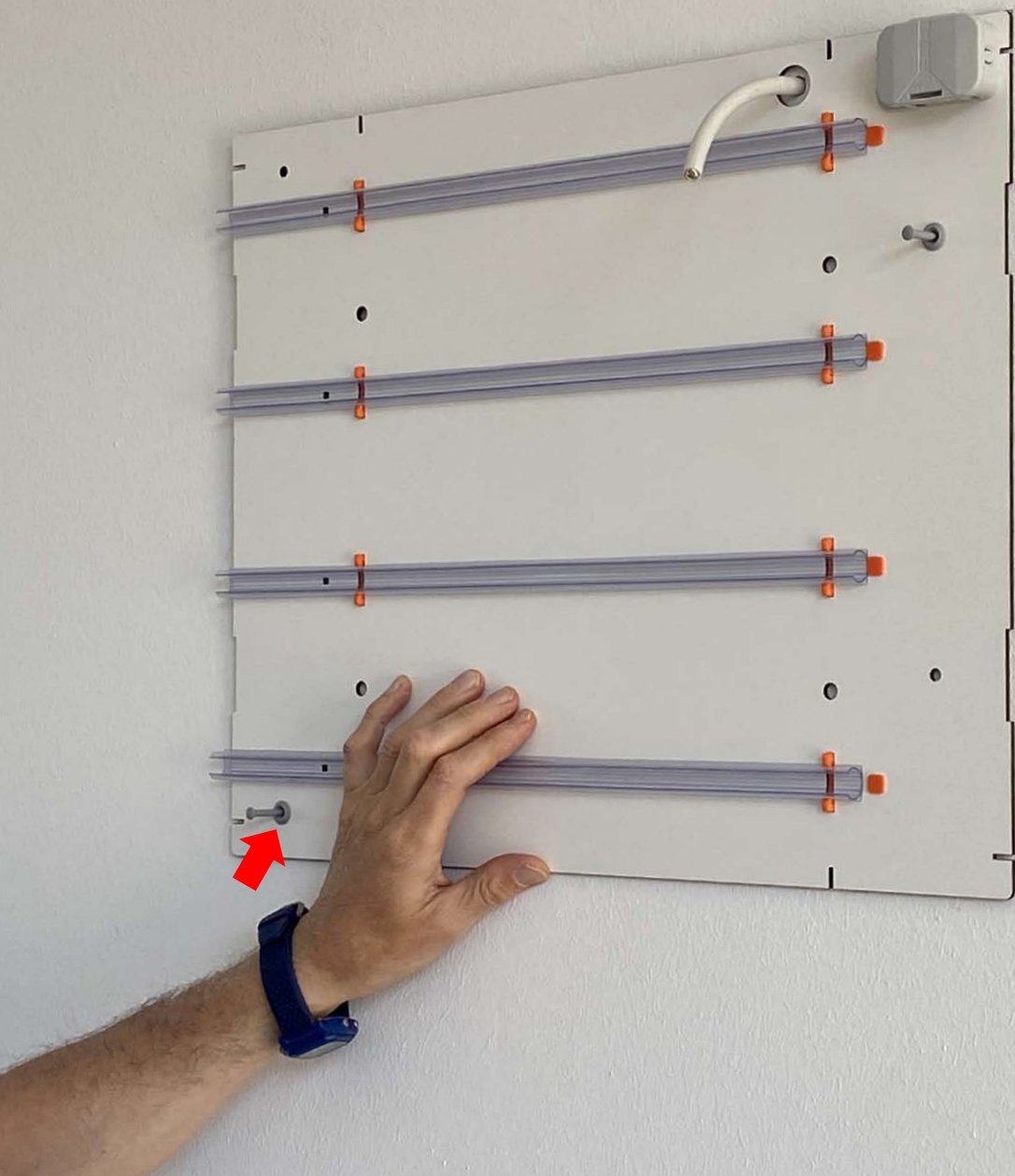



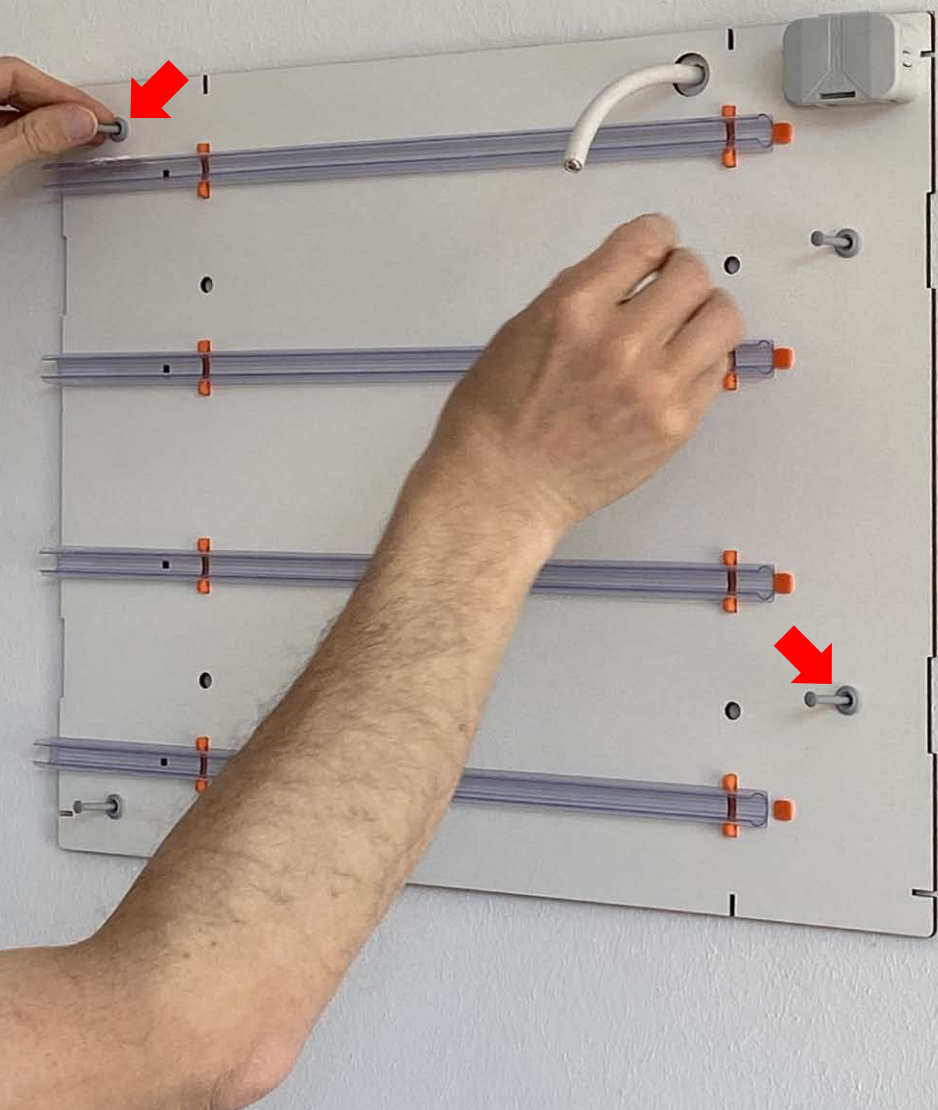



**Abstandskreuze
einschieben.**

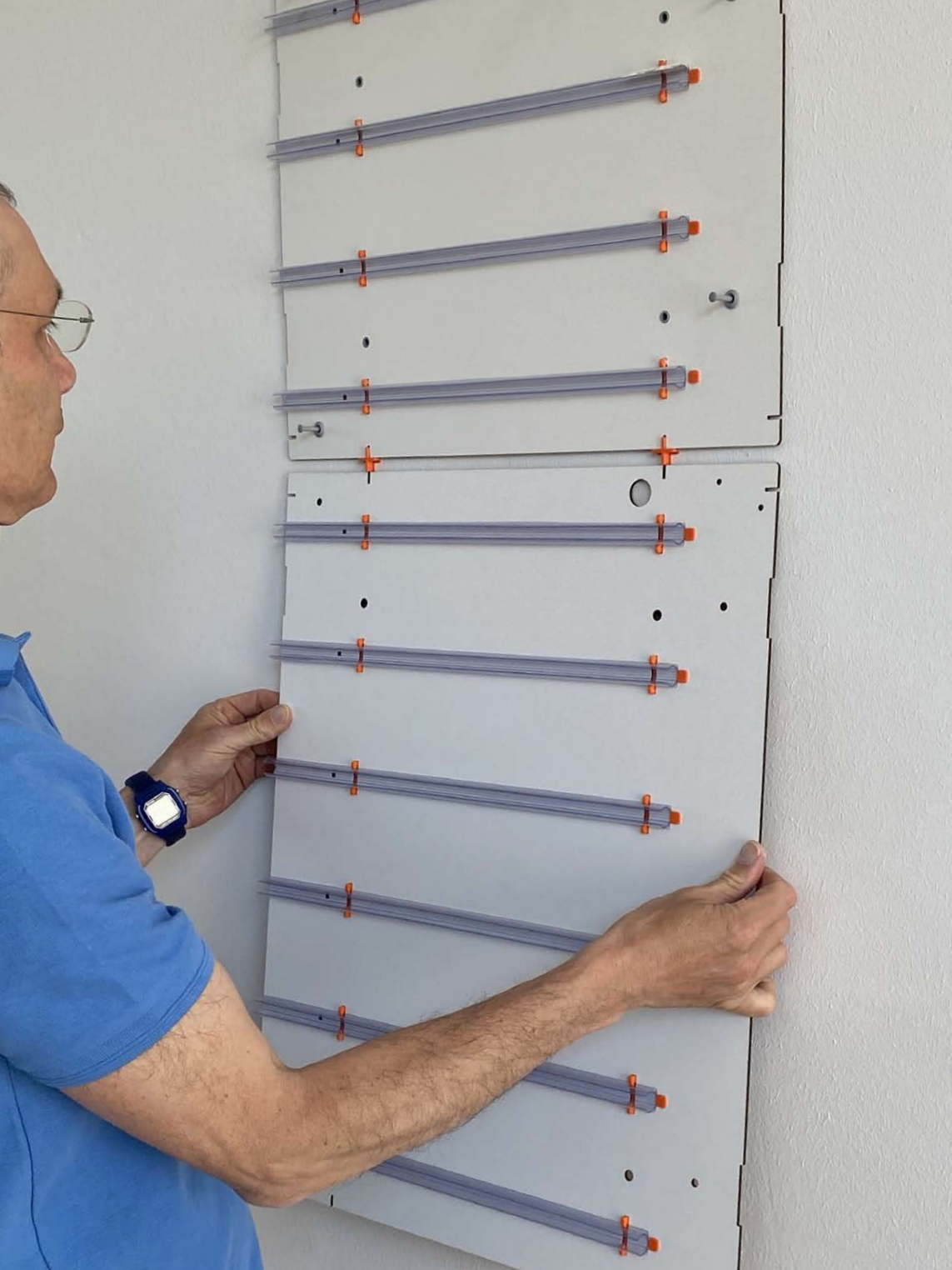

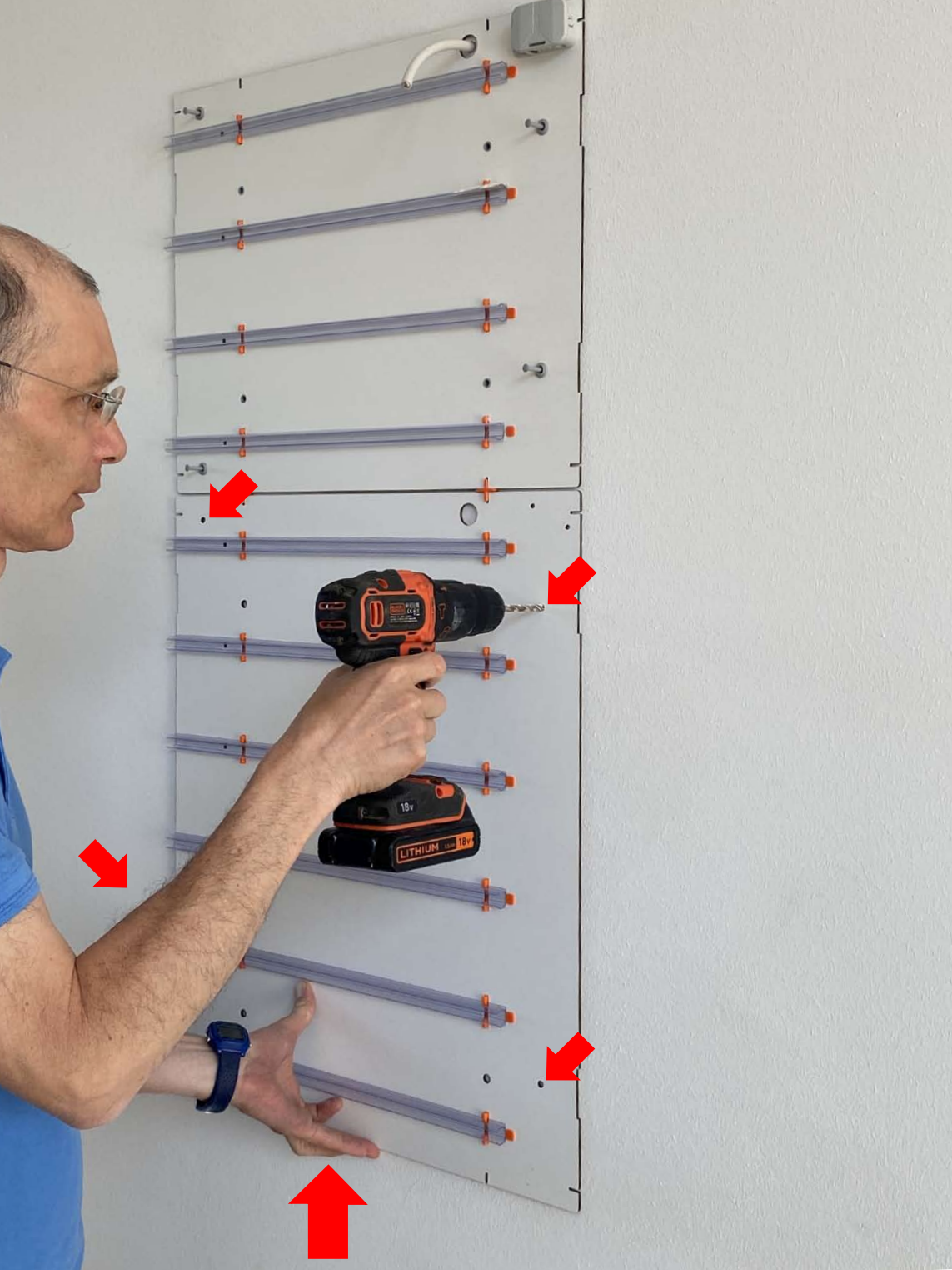

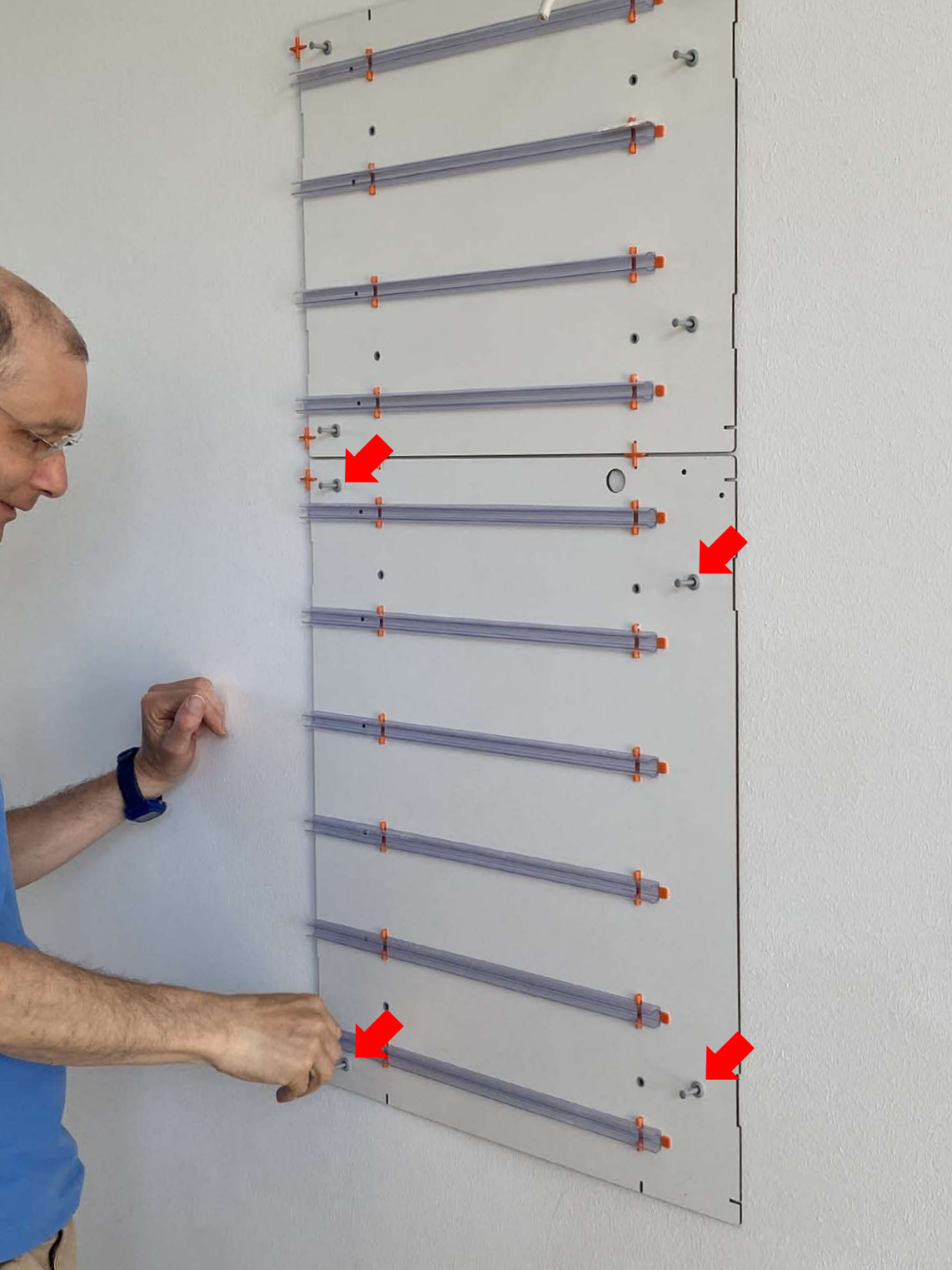

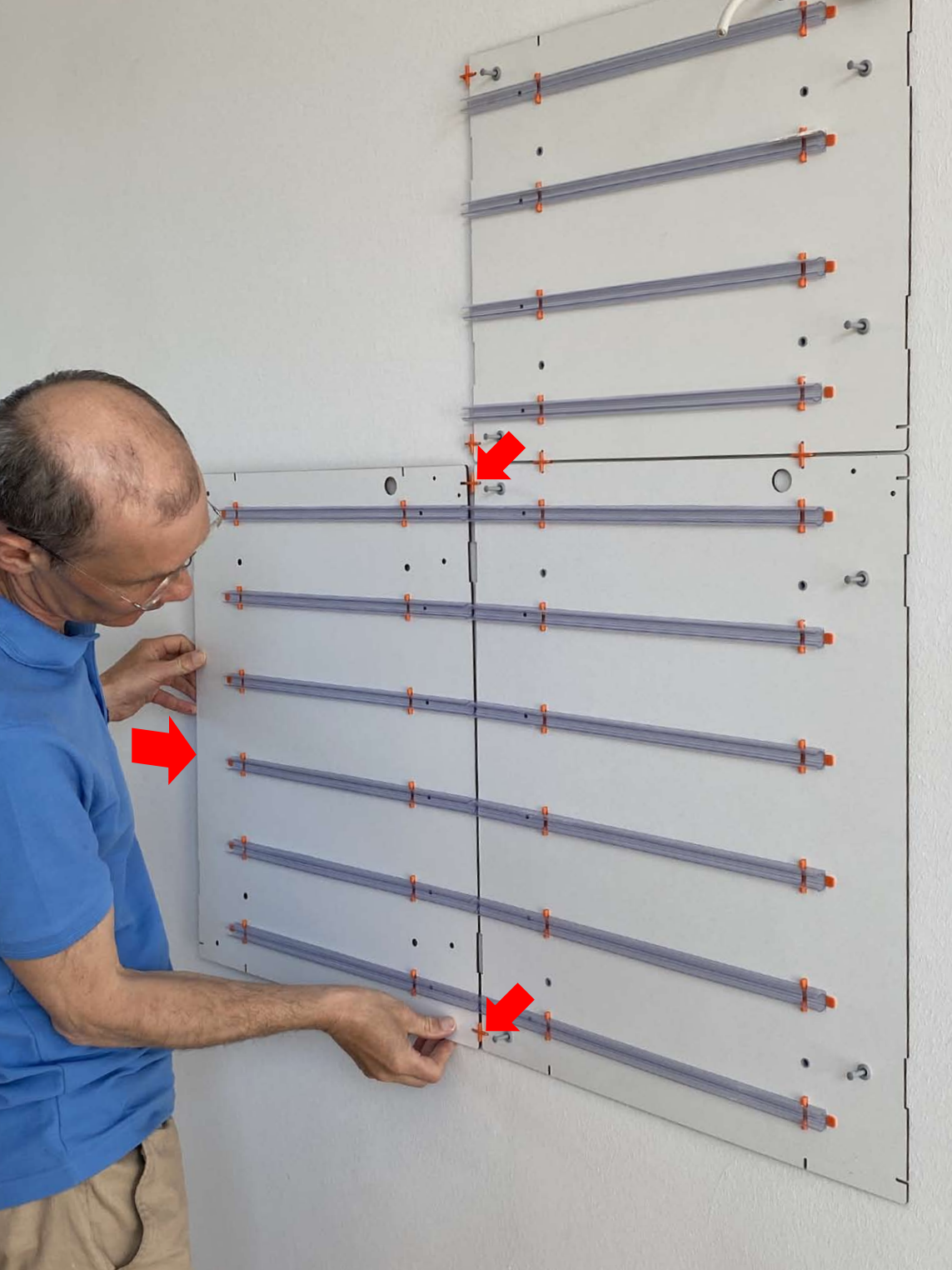

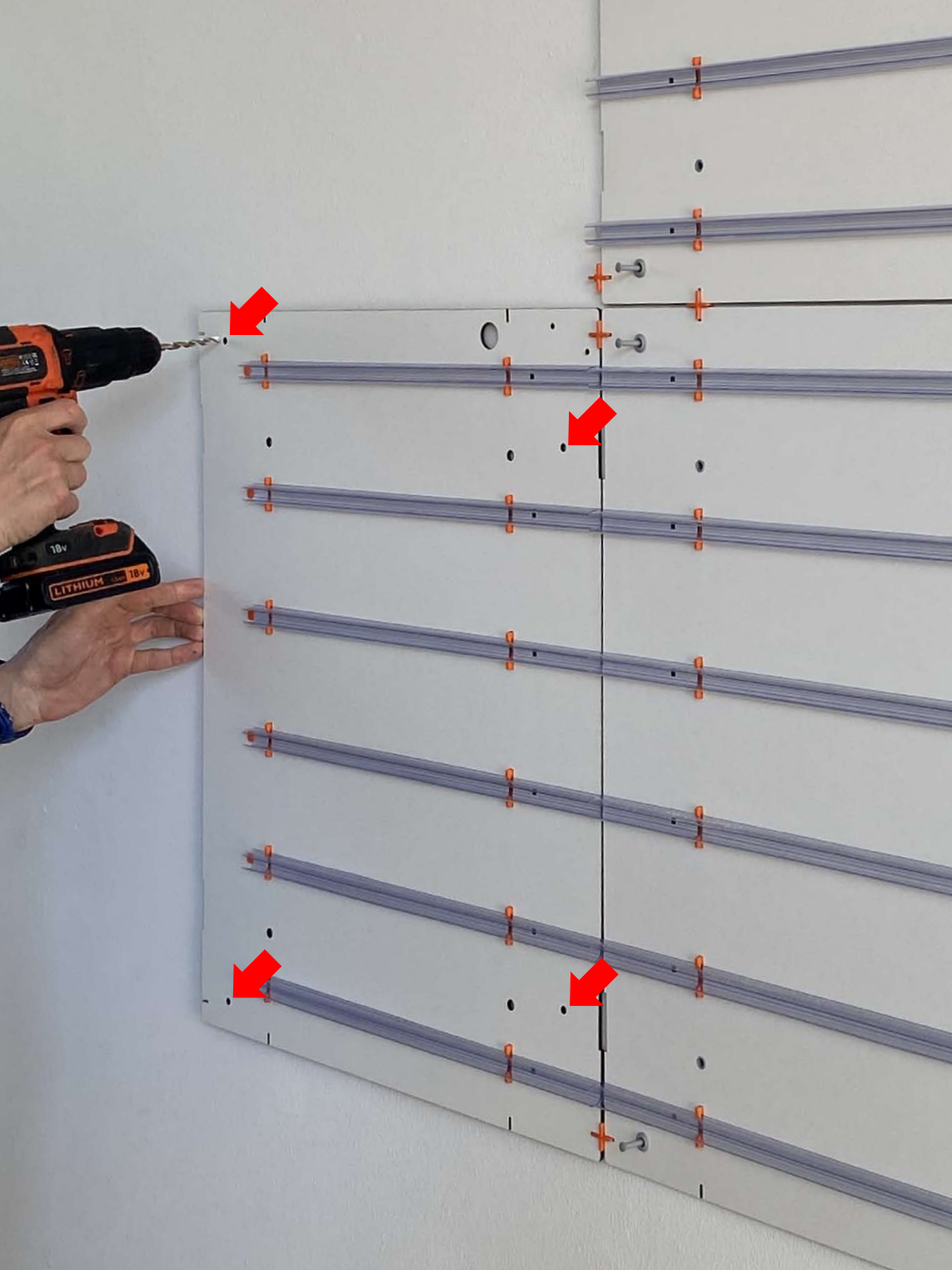

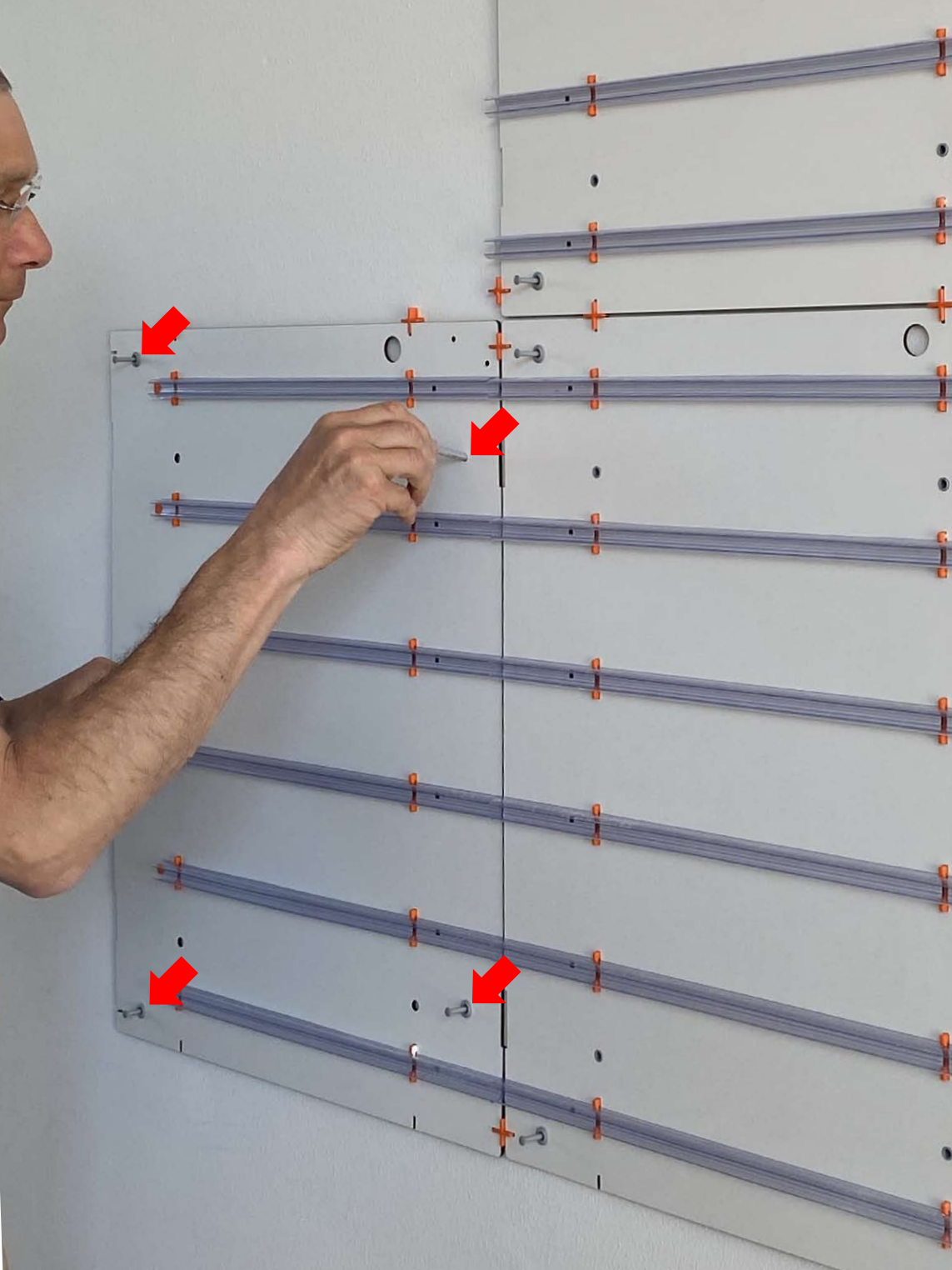

etc.



Ø 8 mm

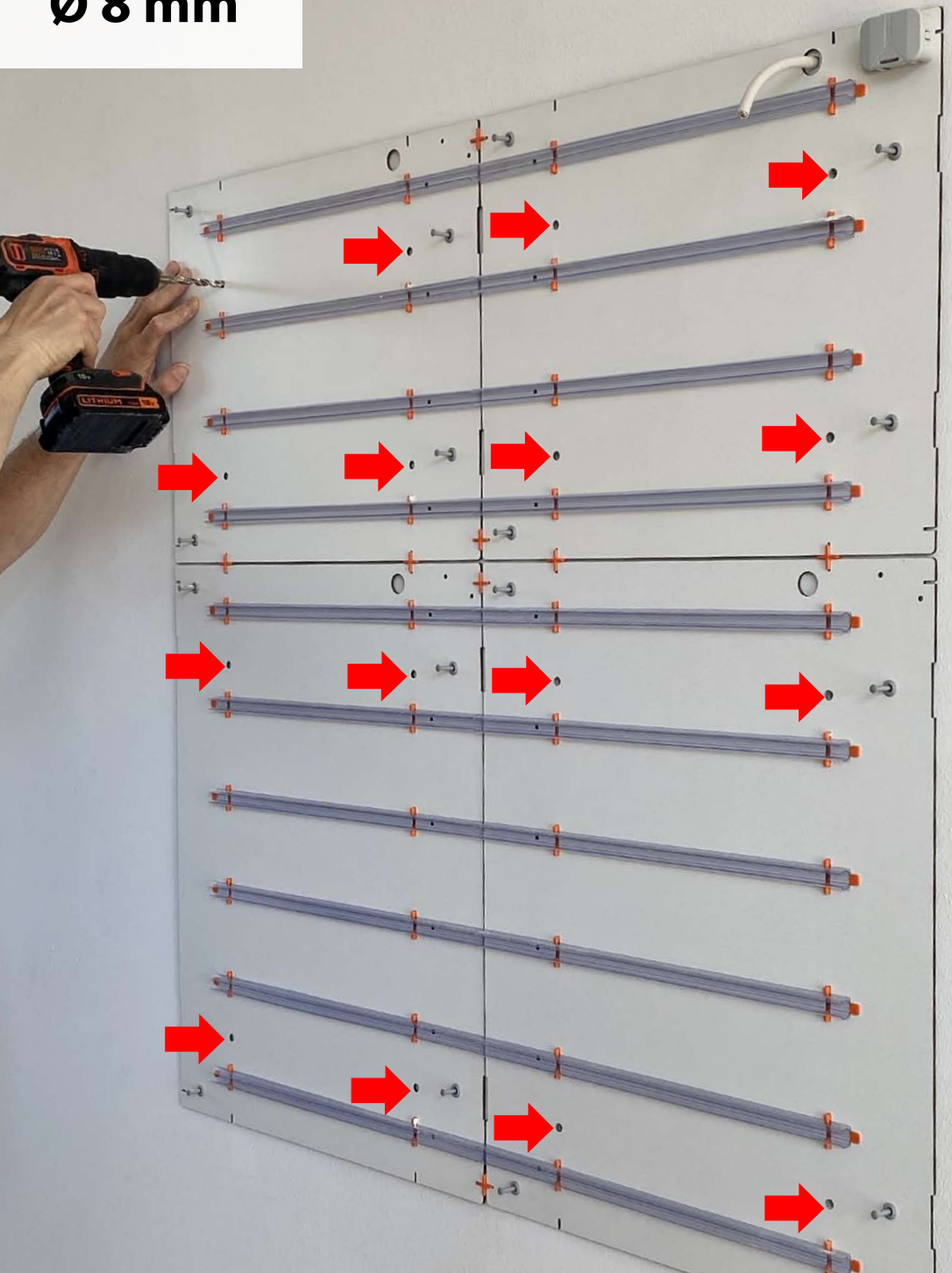

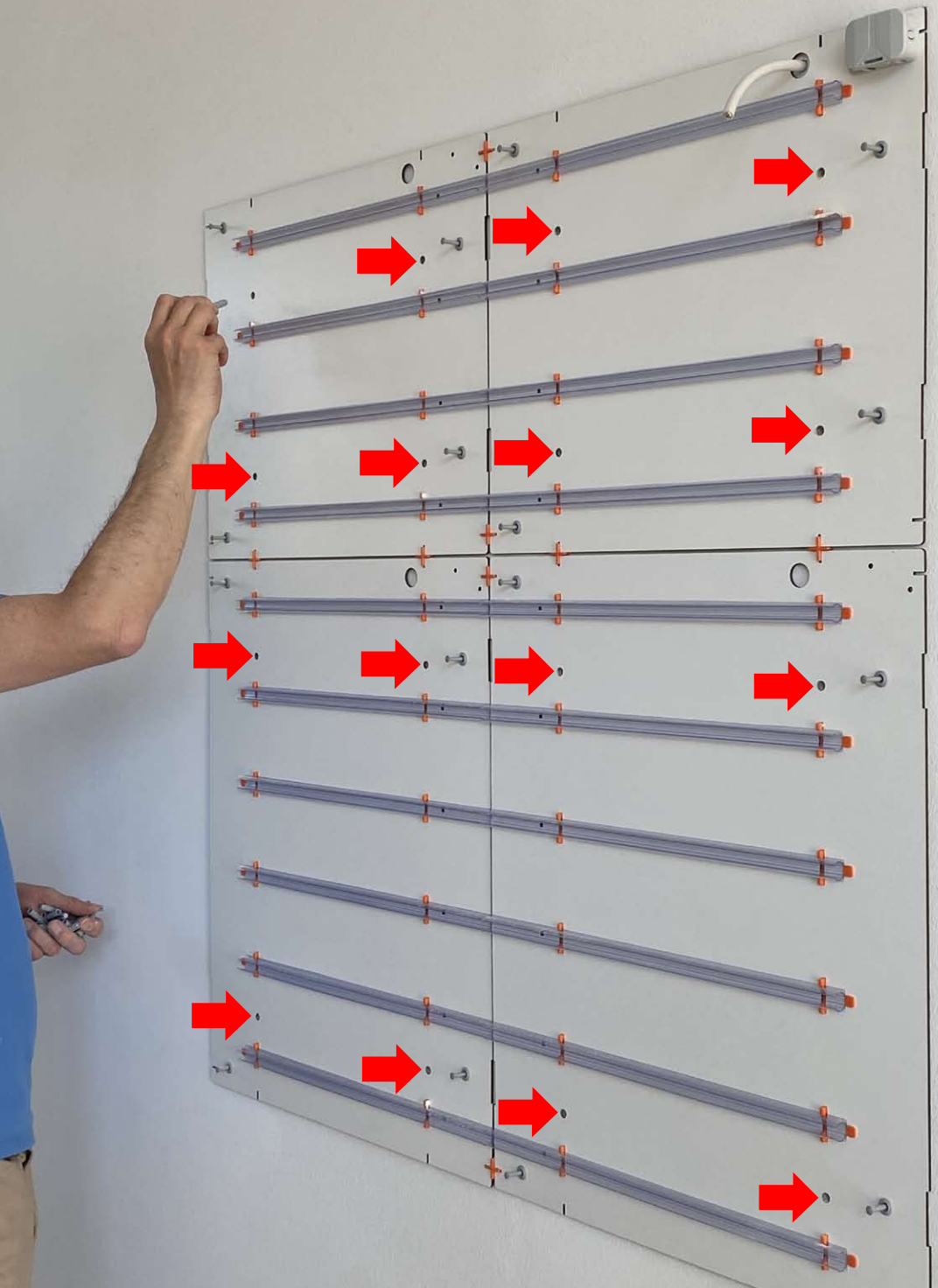





Lichtschlauch möglichst ohne Verdrehungen einlegen.





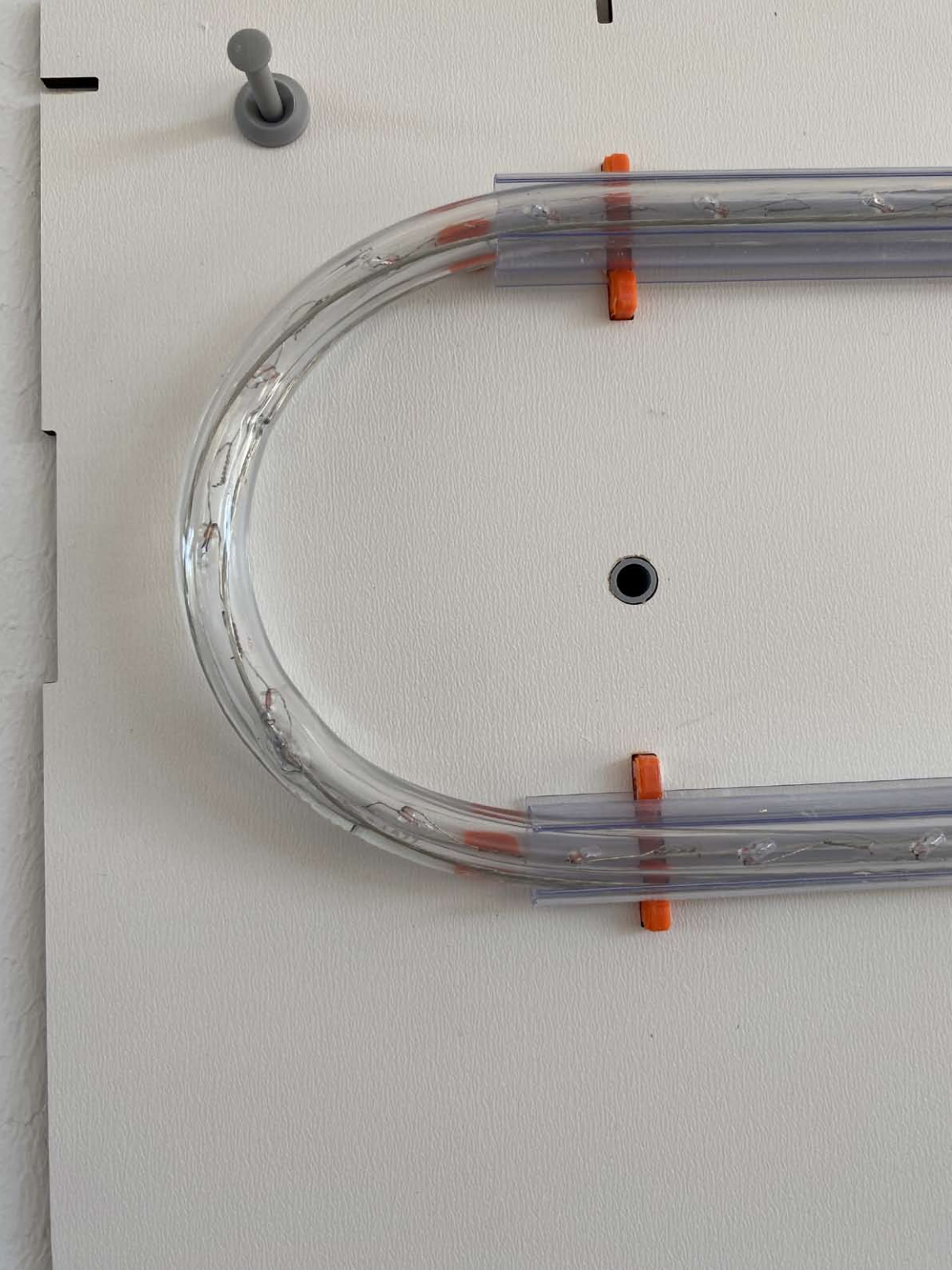

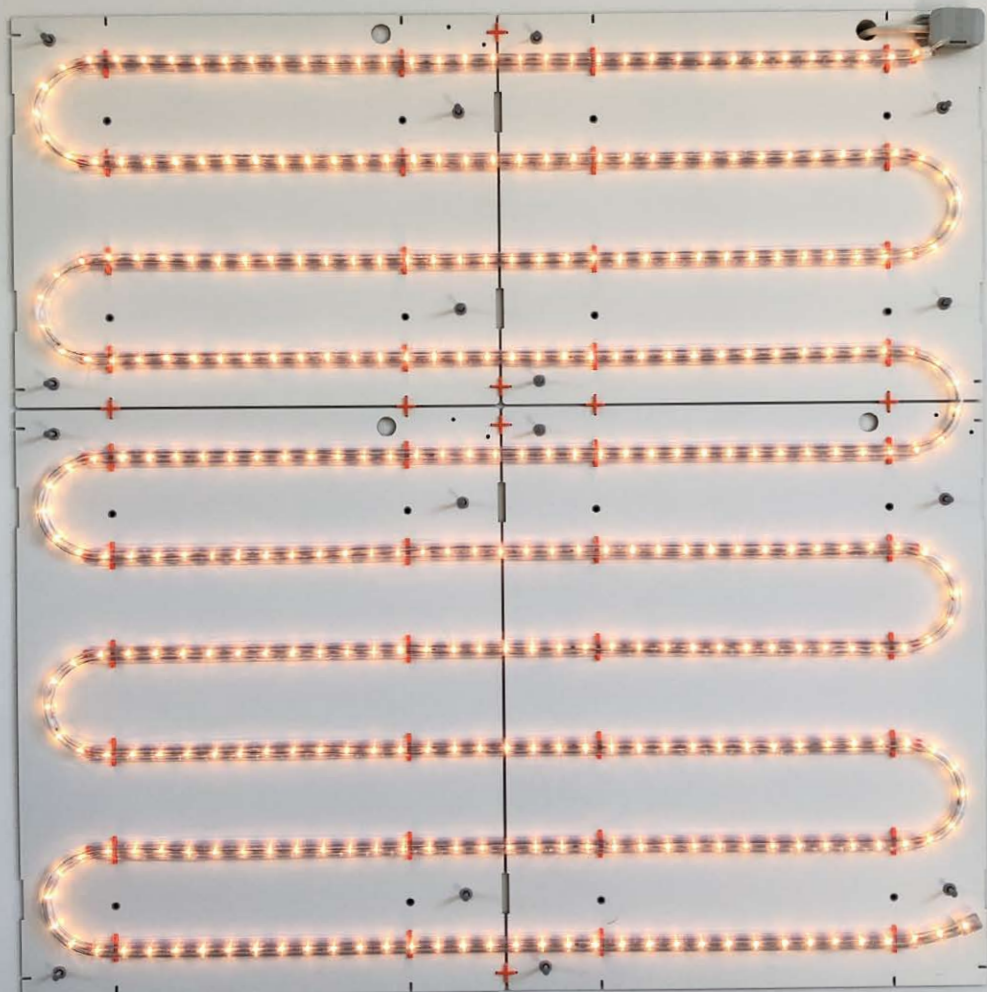



5 mm





**Halter 45° nach
links drehen
und nur lose an-
schrauben (sie
müssen sich noch
drehen lassen)**



**WICHTIG:
Waagerechte
Gitterstäbe
zur Wand!**



**Halter jeweils in die
zweite Masche vom
Rand**

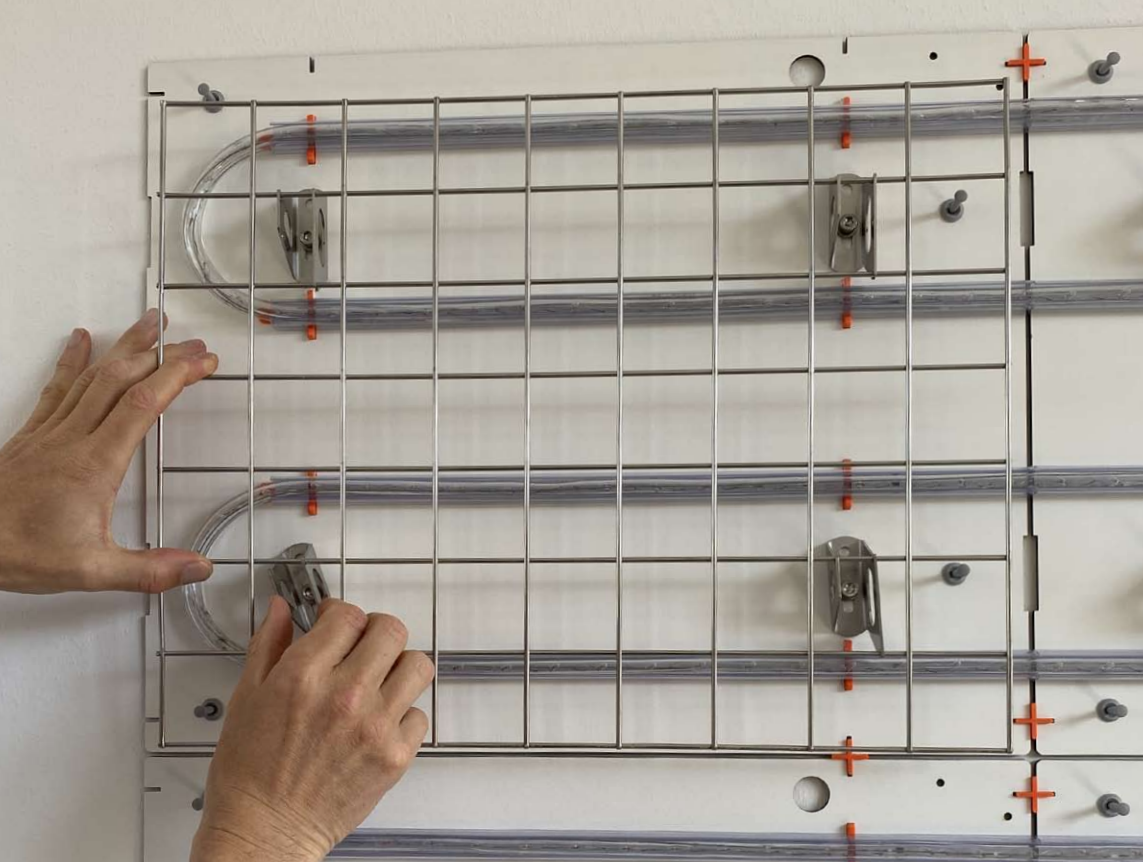

Halter senkrecht drehen, alle Kerben müssen im Gitter einrasten.





**Gitter seitlich ver-
schieben, bis die
Halter mittig zu
den Maschen aus-
gerichtet sind.**

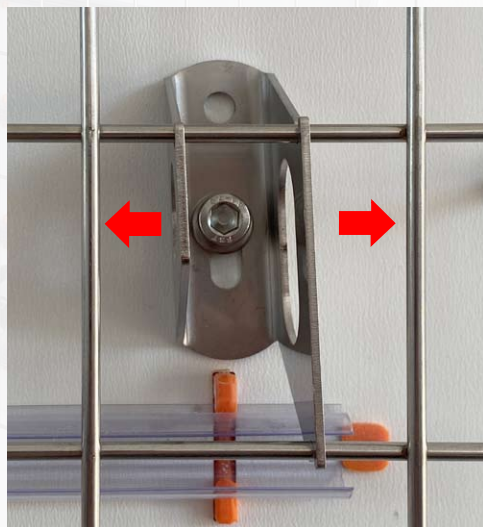



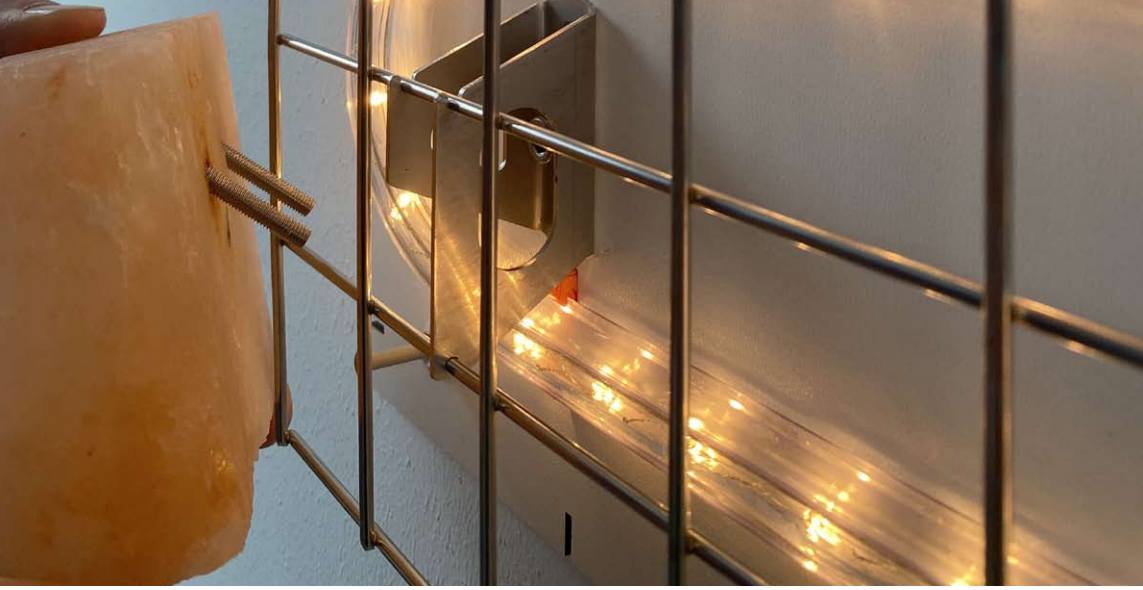

Alle Randsteine sollten mit der Rückplatte fluchten.



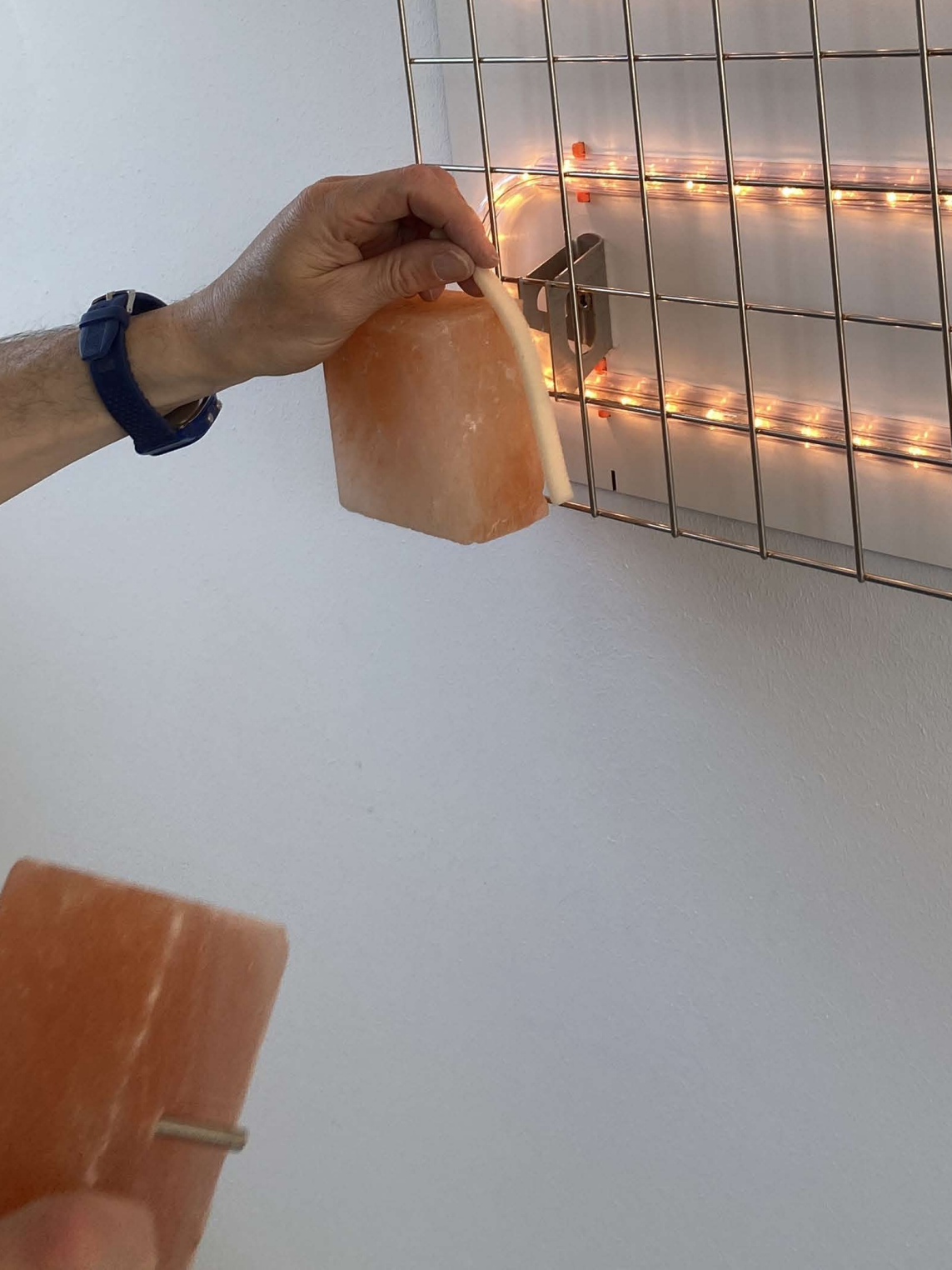

**Salzziegel einhängen und gegen
Schaumstreifen schieben.**

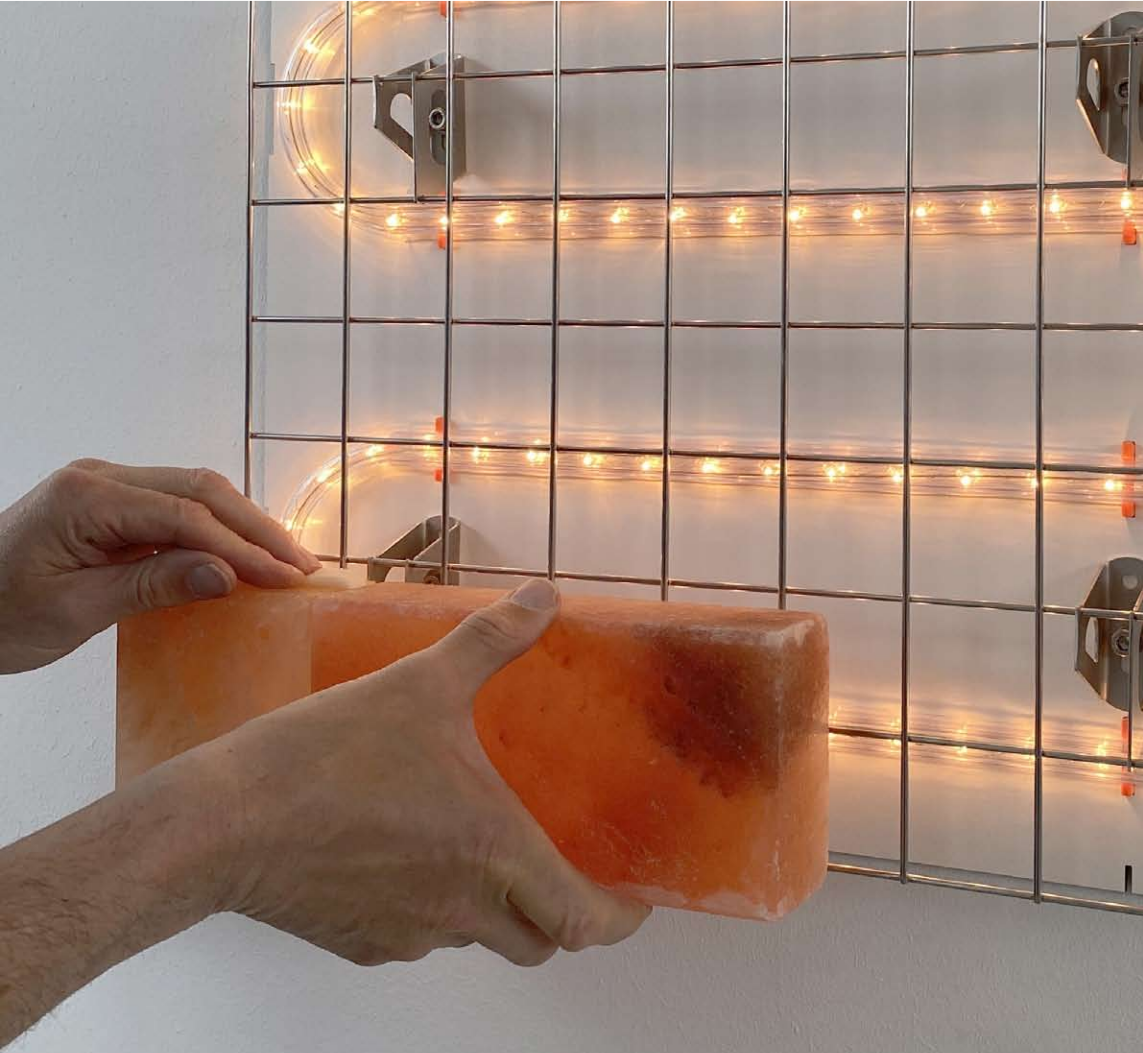





**Zum Niveau-Ausgleich: Gitter-
richter über den Fugen der vorletz-
ten Steinlage einhängen.**

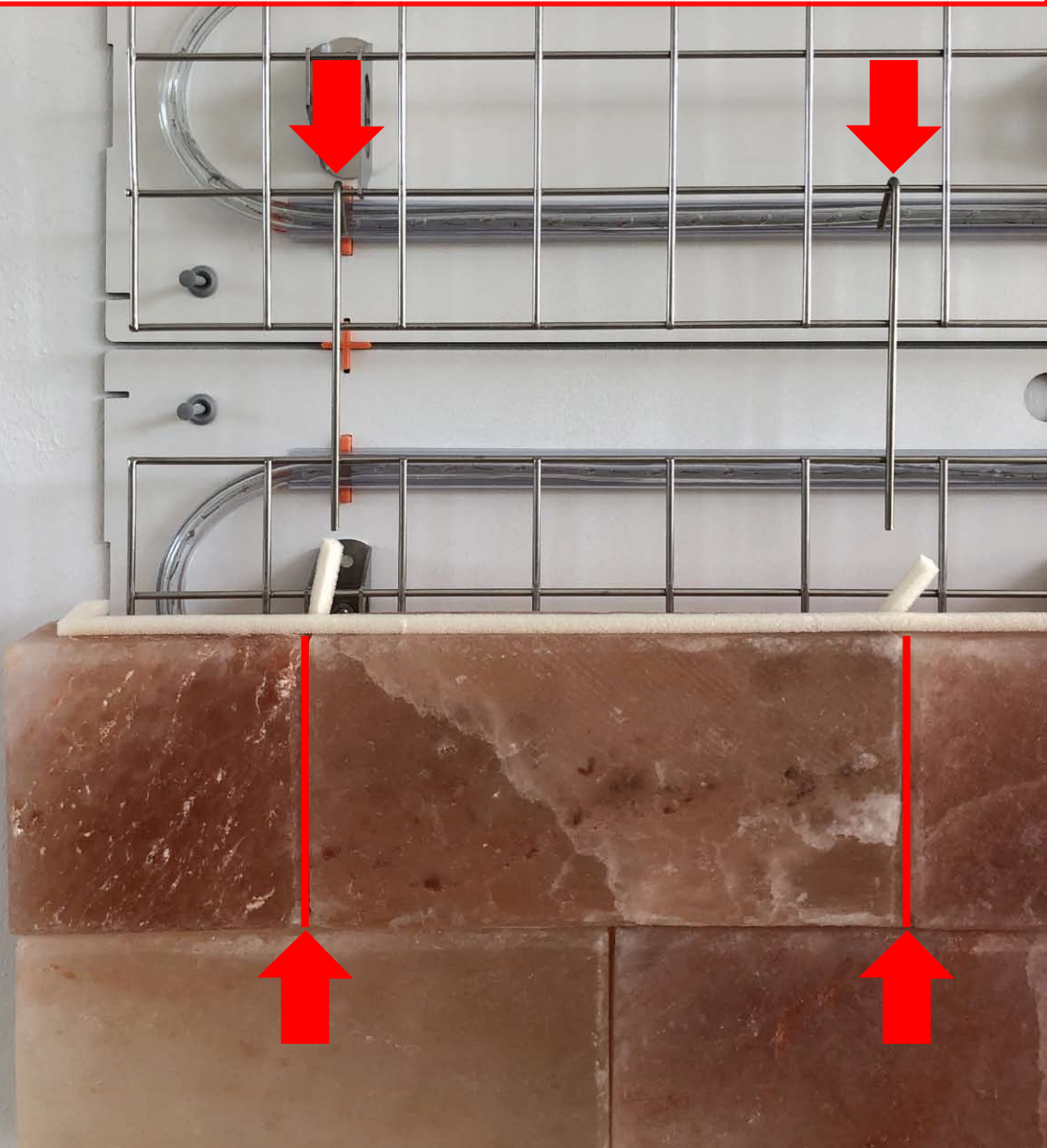

Rändelmutter bündig mit Schraubenende

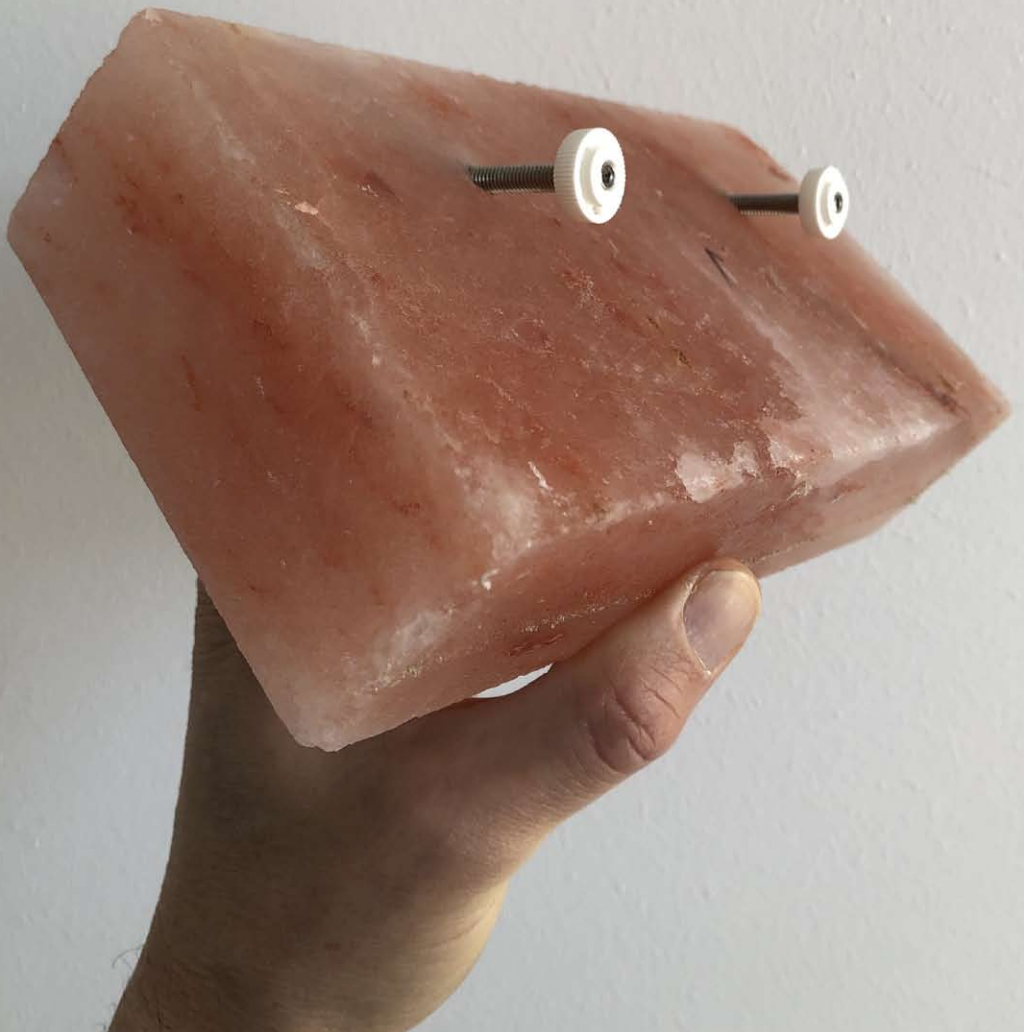

Ziegel einhängen und Rändelmutter festdrehen.



**Überstehende Schaumstreifen
reindrücken.**





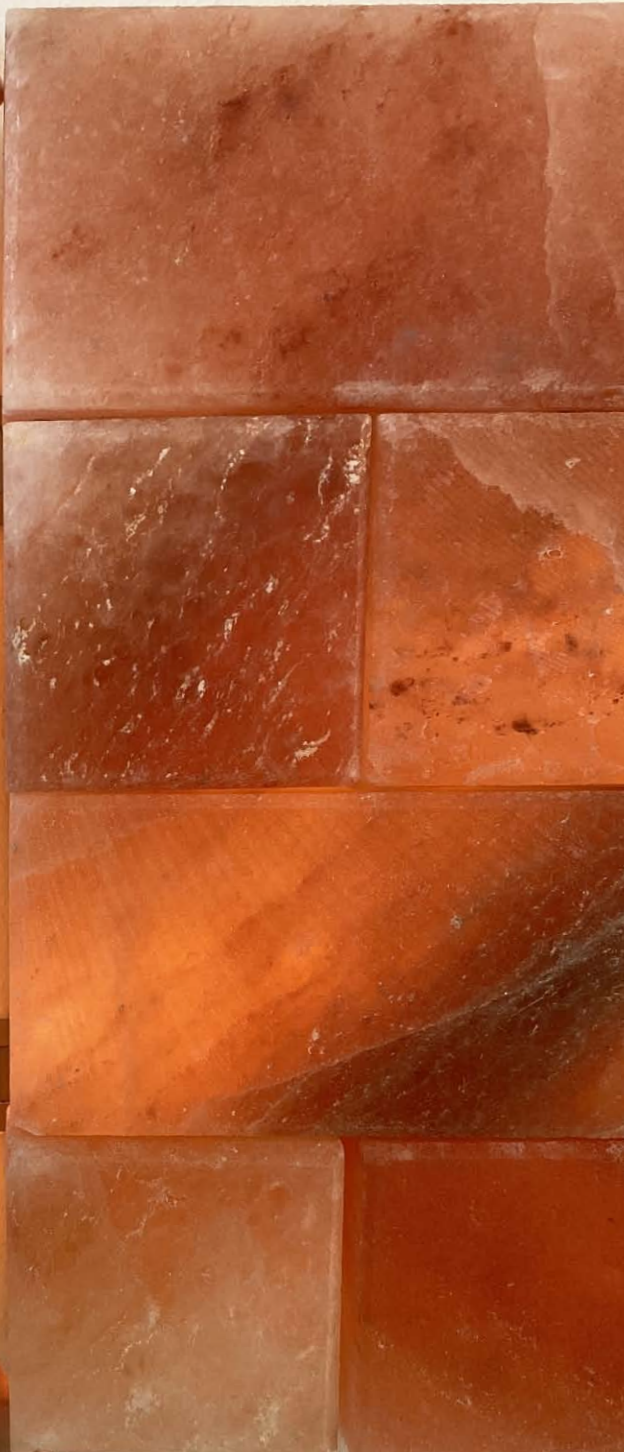

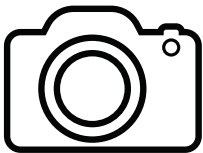

**Über Fotos Ihrer Salzwand
freuen wir uns sehr.**



**Gerne auch mit Kommentar an
info@Bergsalz.com oder
Instagram: @salzwand**