

ELITE
DECOR®

GRAND DECOR



Elite Décor • **GRAND DECOR**

Eng

Elite Décor Industry is a modern high-tech production specialized in producing polymer molded decorations.

The manufacture has all modern technologies for the production of products made of polyurethane foam, polystyrene foam, hybrid and composite polymeric materials. We are constantly developing and improving our products.

The plant includes a design bureau and laboratory that are engaged in new developments.

Our production practice meets modern requirements and is green-minded.

Deu

Elite Décor Industry ist ein modernes hochtechnologisches Werk zur Herstellung von Stuckverzierungen aus Polymeren.

Das Werk besitzt alle heute bekannten Technologien zur Herstellung von Erzeugnissen aus Polyurethanschaum, Schaumpolystyrol, Hybrid- und Polymerverbundmaterialien. Wir entwickeln uns ständig und verbessern unsere Produkte.

Auf der Grundlage der Produktion wurden ein Konstruktionsbüro und ein Laboratorium geschaffen, die sich mit Innovationen und Vorentwicklungen beschäftigen.

Unsere Herstellungstechnologien entsprechen modernen Anforderungen und basieren auf dem Bestreben, die Umwelt zu erhalten.

Fra

Elite Décor Industry, c'est une usine moderne à haute technicité qui fabrique des moules architecturaux décoratives en polymères.

L'usine dispose de toutes les technologies bien connues de fabrication des articles à base de mousse de polyuréthane, de mousse de polystyrène, composites hybrides et plastiques. Nous suivons un rythme ascendant et améliorons constamment la qualité de nos produits. Sur la base de nos capacités de production, il a été créé un bureau d'études et un laboratoire qui se livrent au développement de nouveaux articles.

Nos technologies de production, qui sont basées sur l'aspiration à préserver la qualité de l'environnement, satisfont toujours aux exigences les plus récentes.

Рус

Elite Décor Industry – современный высокотехнологичный завод по производству лепных декоративных украшений из полимеров.

Завод обладает всеми известными на сегодня технологиями производства изделий из пенополиуретана, пенополистирола, гибридных и композитных полимерных материалов. Мы постоянно развиваемся и улучшаем нашу продукцию. На базе производства создано конструкторское бюро и лаборатория, которые занимаются новыми разработками. Наши технологии производства отвечают современным требованиям, и основаны на стремлении сохранения окружающей среды.

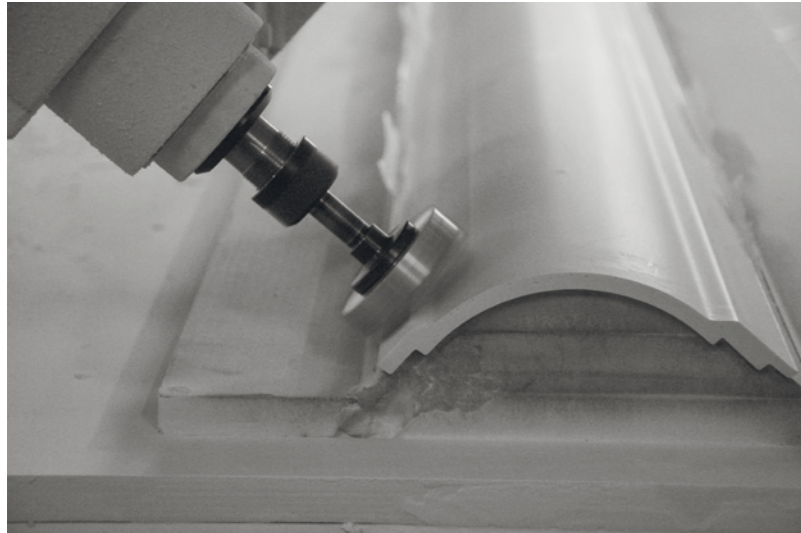

Eng

Elite Décor Industry is a manufacturing and trading company providing an exclusive range and the largest collection of decorative elements in the world. It produces the collections of interior and facade decor under the following world famous brands: GRAND DECOR, TESORI, DECOWOOD, PRESTIGE DECOR, ART & ARXAT.

Deu

Elite Décor Industry ist ein Produktions- und Handelsunternehmen, das ein exklusives Sortiment und die weltweit größte Sammlung von dekorativen Elementen bietet. Es stellt Kollektionen von Innen- und Fassadendekor unter den weltbekanntesten Handelsmarken GRAND DECOR, TESORI, DECOWOOD, PRESTIGE DECOR, ART&ARXAT her.

Fra

Elite Décor Industry est une entreprise technico-commerciale qui propose l'assortiment exclusif et la collection d'éléments décoratifs la plus grande du monde. Elle fabrique des collections de décoration pour l'intérieur et la façade livrées sous les marques mondialement connues GRAND DECOR, TESORI, DECOWOOD, PRESTIGE DECOR, ART & ARXAT.

Рус

Elite Décor Industry – производственно-торговое предприятие, предоставляющее эксклюзивный ассортимент и наибольшее в мире собрание декоративных элементов. Производит коллекции интерьерного и фасадного декора под всемирно известными торговыми марками GRAND DECOR, TESORI, DECOWOOD, PRESTIGE DECOR, ART&ARXAT.





Eng

■ Cornices	7	■ Ornamental wall moldings	47	■ Ceiling rails	87	■ Columns	105
■ Curtain Profiles	25	■ Corner moulding elements	51	■ Wall panels	89	■ Corbels	107
■ Lighting mouldings	27	■ Baseboard	55	■ Cupolas	91	■ Decorative elements	111
■ Cornices with ornament	31	■ High Density Polymer	59	■ Door frames	97	■ Niches	115
■ Wall moldings	41	■ Ceiling roses	81	■ Pilasters	101	■ Information	117

Deu

■ Glatte Gesimse	7	■ Leisten mit Ornament	47	■ Bogen	87	■ Säulen	105
■ Gardinenstangen	25	■ Winkelelemente	51	■ Wandpaneelen	89	■ Konsolen	107
■ Gesimse mit LED	27	■ Sockelleisten	55	■ Deckenkuppeln	91	■ Ornamente	111
■ Gesimse mit Ornament	31	■ Polymer mit hoher Dichte	59	■ Umrahmungen der Türöffnung	97	■ Nischen	115
■ Glatte Leisten	41	■ Rosetten	81	■ Pilaster	101	■ das Datenmaterial	117

Fra

■ Corniches lisses	7	■ Moulures avec ornement	47	■ Arcs	87	■ Colones	105
■ Tringle à rideaux	25	■ Eléments d'angle	51	■ Panneaux muraux	89	■ Consoles	107
■ Corniches avec éclairage LED	27	■ Plinthes	55	■ Dômes de plafond	91	■ Ornaments	111
■ Corniches avec ornement	31	■ Polymère haute densité	59	■ Encadrement de porte	97	■ Niches	115
■ Moulures lisses	41	■ Prises de courant	81	■ Pilastres	101	■ L'information	117

Рус

■ Гладкие карнизы	7	■ Молдинги с орнаментом	47	■ Дуги	87	■ Колонны	105
■ Шторные карнизы	25	■ Угловые элементы	51	■ Стенные панели	89	■ Консоли	107
■ Карнизы с ЛЭД	27	■ Плинтусы	55	■ Потолочные купола	91	■ Орнаменты	111
■ Карнизы с орнаментом	31	■ Полимер высокой плотности	59	■ Обрамление дверей	97	■ Ниши	115
■ Гладкие молдинги	41	■ Розетки	81	■ Пилястры	101	■ Информация	117

Eng

GRAND DÉCOR is a great variety of decorative elements designed to embody your individuality in the interior. Create your own design with indirect lighting cornices, which will bring comfort to any interior both classic and modern. Shock-resistant and waterproof floor skirting will add the final flourish to the interior. The GRAND DÉCOR collection is a designer for endless styles and original interior solutions combinations.

Deu

GRAND DÉCOR – eine riesige Vielfalt an dekorativen Elementen für die Verkörperung der Individualität in Ihrem Interieur. Kreieren Sie Ihr eigenes Design mit Gesimsen für indirekte Beleuchtung, sie werden jedem Interieur, vom klassischen bis modernen, Gemütlichkeit verleihen. Stoßfeste und wasserdichte Sockelleisten werden es Ihnen ermöglichen, dem Interieur den letzten Schliff zu geben. Die Sammlung von GRAND DÉCOR stellt einen Bausatz für grenzenlose Stilkombinationen und originelle Einrichtungslösungen dar.

Fra

GRAND DÉCOR, c'est une grande variété d'objets décoratifs permettant d'instaurer l'individualité dans votre intérieur. Créez votre propre design avec des corniches destinées à l'éclairage indirect, elles ajouteront du confort à n'importe quel intérieur, du classique au moderne. Les plinthes résistantes aux chocs et à l'humidité offriront une touche finale à l'intérieur de votre immeuble. La collection GRAND DÉCOR est un créateur de combinaisons sans limites de styles et de solutions originales pour l'intérieur.

Рус

GRAND DÉCOR – огромное разнообразие декоративных элементов для воплощения индивидуальности в Вашем интерьере. Создайте свой дизайн с карнизами для непрямого освещения, они добавят уюта любому интерьеру от классического до современного. Придать интерьеру последний штрих помогут ударопрочные и влагостойкие плинтуса. Коллекция GRAND DÉCOR это конструктор для безграничных комбинаций стилей и оригинальных интерьерных решений.



P 879 · P 879F
3 x 2 cm



P 879 · P 879F
2 x 3 cm

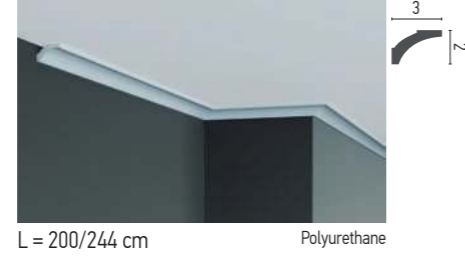

P 941 · P 941F
5,1 x 4,8 cm



P 944 · P 944F
6,1 x 6,9 cm



P 942 · P 942F
21,6 x 21,6 cm



P 907 · P 907F
12 x 11 cm



P 907 · P 907F
11 x 12 cm



P 880 · P 880F
17 x 12 cm



P 880 · P 880F
12 x 17 cm



P 888 · P 888F
18 x 14 cm

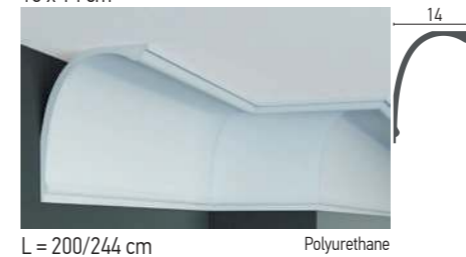

P 888 · P 888F
14 x 18 cm

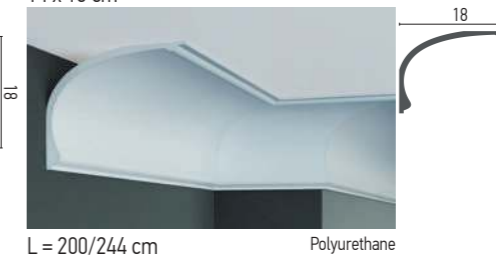

P 856 · P 856F
10 x 6,8 cm



L = 200/244 cm Polyurethane

P 856 · P 856F
6,8 x 10 cm

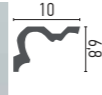

L = 200/244 cm Polyurethane

P 833 · P 833F
15,5 x 10,2 cm



L = 200/244 cm Polyurethane

P 833 · P 833F
10,2 x 15,5 cm

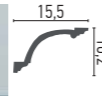

L = 200/244 cm Polyurethane

P 825
23 x 11 cm



L = 200/244 cm Polyurethane

P 825
11 x 23 cm

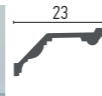

L = 200/244 cm Polyurethane

P 949 · P 949F
14,5 x 11,3 cm



L = 200/244 cm Polyurethane

P 949 · P 949F
11,3 x 14,5 cm

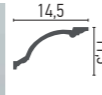

L = 200/244 cm Polyurethane

P 947
22 x 11,7 cm



L = 200/244 cm Polyurethane

P 947
11,7 x 22 cm

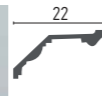

L = 200/244 cm Polyurethane



P 922 · P 922F
4 x 4 cm



L = 200/244 cm Polyurethane

P 872 · P 872F
9,7 x 6,3 cm



L = 200/244 cm Polyurethane

P 872 · P 872F
6,3 x 9,7 cm



L = 200/244 cm Polyurethane

P 836 · P 836F
12,4 x 5,8 cm



L = 200/244 cm Polyurethane

P 836 · P 836F
5,8 x 12,4 cm



L = 200/244 cm Polyurethane



P 925
5 x 5 cm



L = 200/244 cm Polyurethane

P 904 · P 904F
5,5 x 5,5 cm



L = 200/244 cm Polyurethane

P 930 · P 930F
6 x 6 cm



L = 200/244 cm Polyurethane

P 821 · P 821F
7 x 5 cm



L = 200/244 cm Polyurethane

P 893
9 x 6,5 cm



L = 200/244 cm Polyurethane



P 821 · P 821F
5 x 7 cm



L = 200/244 cm Polyurethane

P 893
6,5 x 9 cm



L = 200/244 cm Polyurethane

P 932 · P 932F
4 x 4 cm



L = 200/244 cm Polyurethane

P 932 · P 932F
4 x 4 cm



L = 200/244 cm Polyurethane

P 807 · P 807F
7,3 x 6,8 cm



L = 200/244 cm Polyurethane

P 807 · P 807F
6,8 x 7,3 cm



L = 200/244 cm Polyurethane

P 803 · P 803F
7,6 x 7,5 cm



L = 200/244 cm Polyurethane

P 910 · P 910F
10,5 x 8,7 cm



L = 200/244 cm Polyurethane

P 910 · P 910F
8,7 x 10,5 cm



L = 200/244 cm Polyurethane

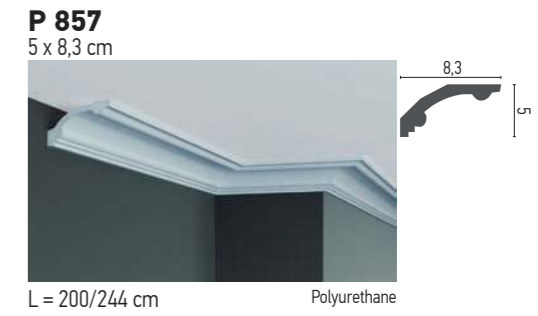

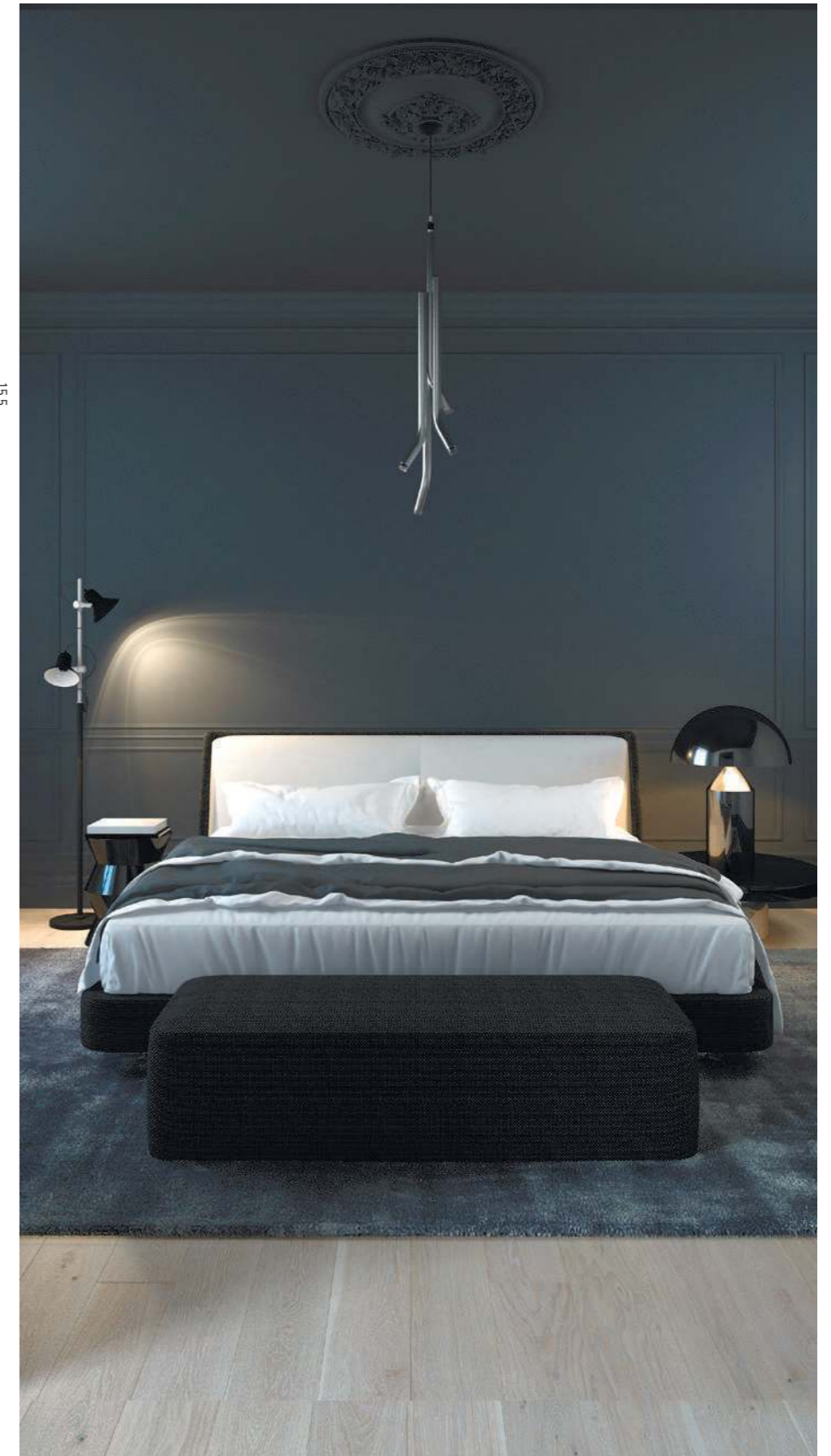



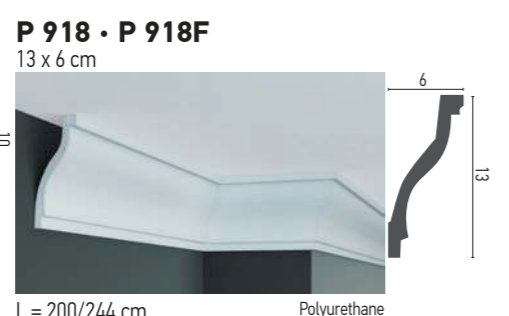
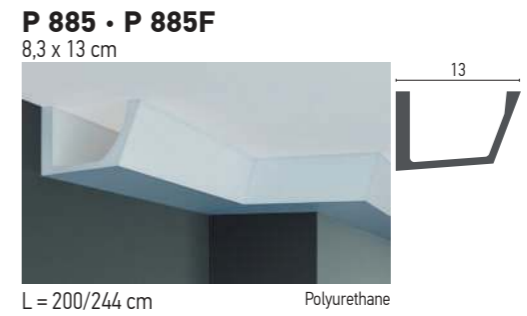
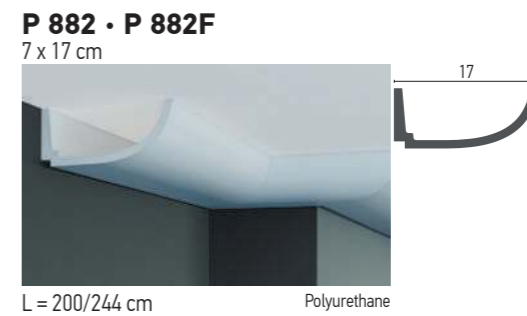
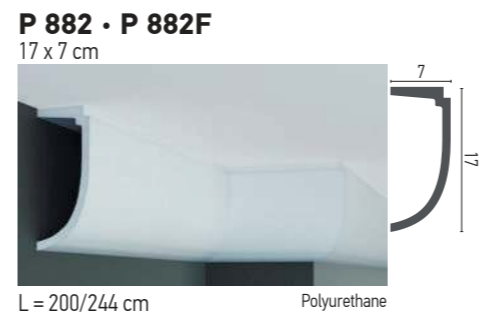
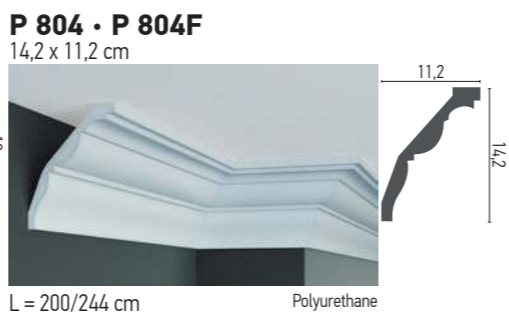



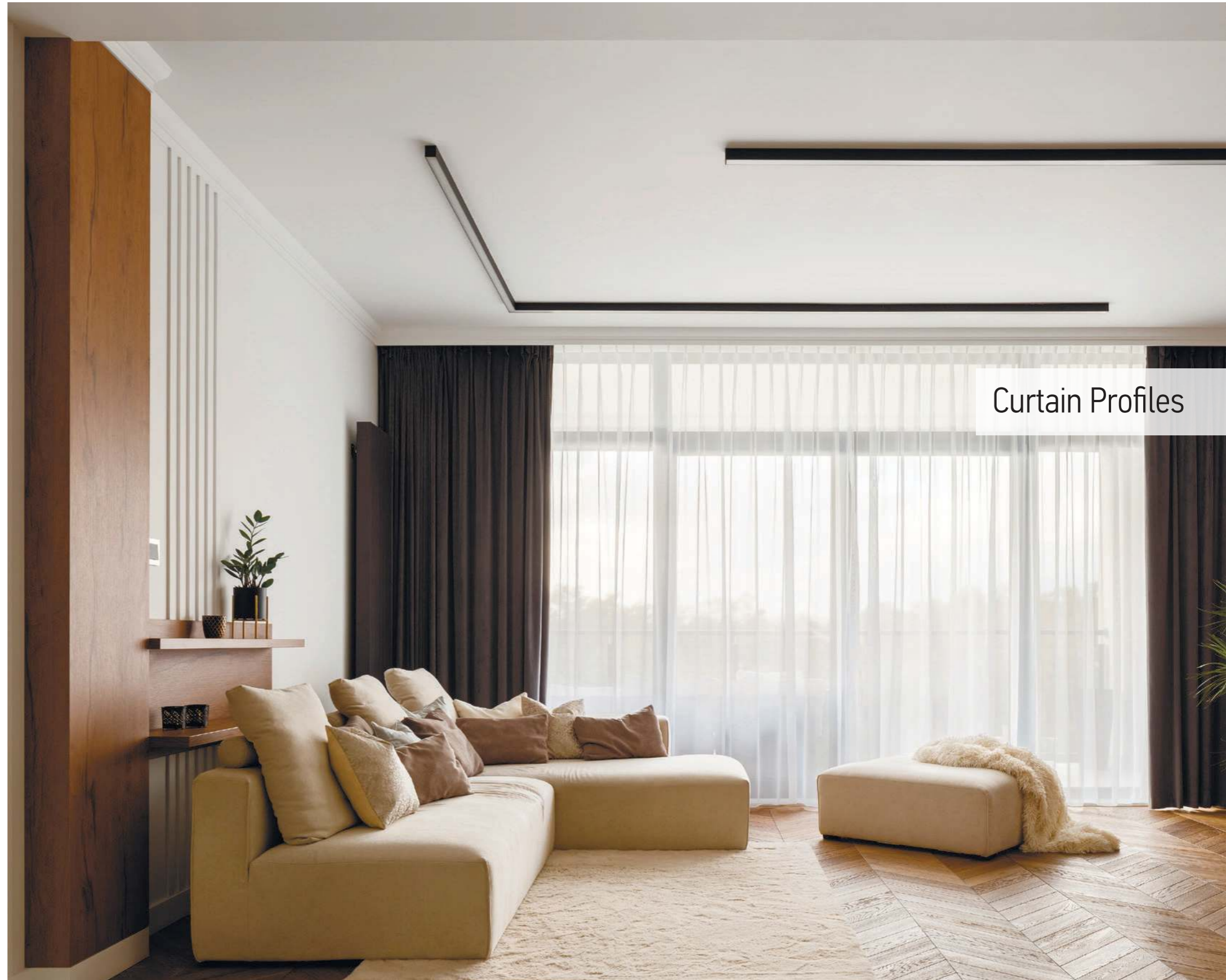

P 889

10 x 5 cm



L = 200/244 cm

Polyurethane

P 890

11 x 4 cm



L = 200/244 cm

Polyurethane

P 894 · P 894F

11 x 2 cm



L = 200/244 cm

Polyurethane



P 891 · P 891F

13 x 5 cm



L = 200/244 cm

Polyurethane

P 895 · P 895F

13 x 3,16 cm



L = 200/244 cm

Polyurethane



P 920
5 x 5 cm



L = 200/244 cm Polyurethane

P 834
5,8 x 6,6 cm



L = 200/244 cm Polyurethane

P 933
15 x 12,4 cm



L = 200/244 cm Polyurethane

P 838
11 x 9 cm



L = 200/244 cm Polyurethane

P 926
14,5 x 16,5 cm



L = 200/244 cm Polyurethane

P 855
9,2 x 9 cm



L = 200/244 cm Polyurethane

P 837
18,3 x 15,1 cm



L = 200/244 cm Polyurethane

P 927
7,6 x 10,2 cm



L = 200/244 cm Polyurethane

P 887
8 x 8 cm

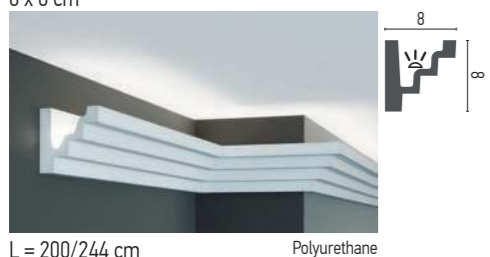

L = 200/244 cm Polyurethane

P 937
12,5 x 12,5 cm



L = 200/244 cm Polyurethane

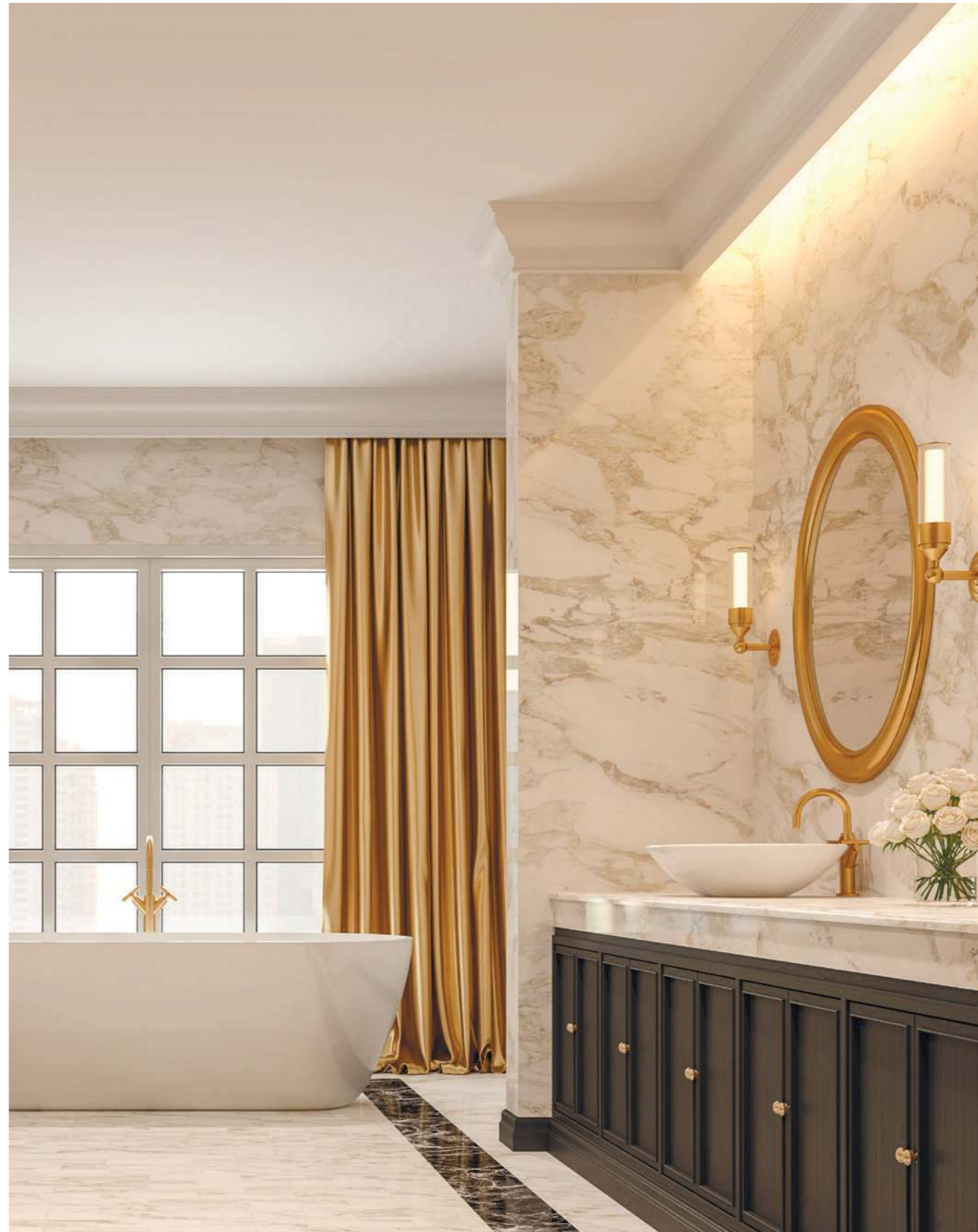

P 883
6 x 12,5 cm

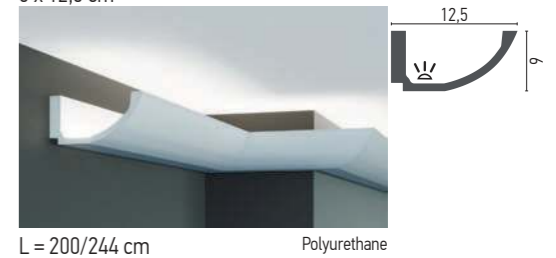

L = 200/244 cm Polyurethane

P 882
7 x 17 cm

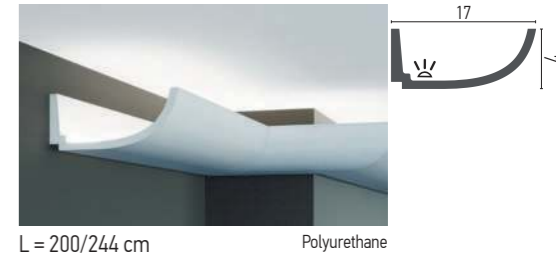

L = 200/244 cm Polyurethane

P 885
8,3 x 13 cm

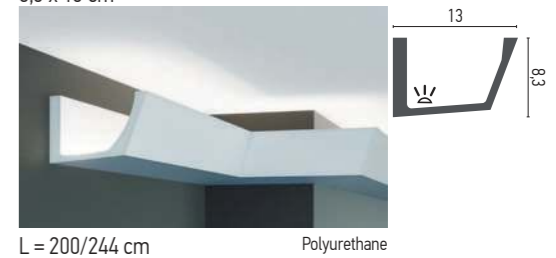

L = 200/244 cm Polyurethane

P 881
5,5 x 8,7 cm

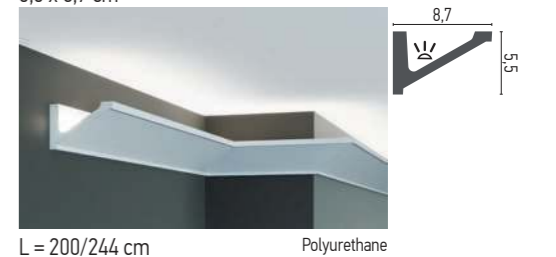

L = 200/244 cm Polyurethane

P 884
9 x 14 cm

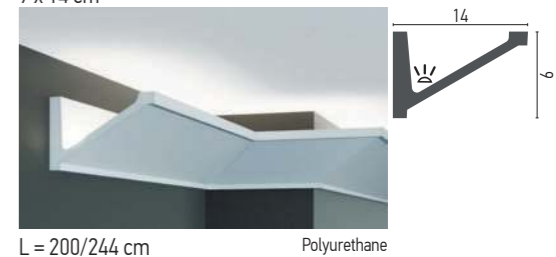

L = 200/244 cm Polyurethane



Cornices with ornament

C 904 · C 904F
8,1 x 8,3 cm



L = 200/244 cm Polyurethane

C 710
7,6 x 6,4 cm



L = 200/244 cm Polyurethane

C 788 · C 788F
10,4 x 6,2 cm



L = 200/244 cm Polyurethane

C 702
8,2 x 5 cm



L = 200/244 cm Polyurethane

C 745 · C 745F
12,4 x 7,2 cm



L = 200/244 cm Polyurethane

C 738
8,5 x 8,5 cm



L = 200/244 cm Polyurethane

C 704 · C 704F
8,6 x 5 cm



L = 200/244 cm Polyurethane

C 725
11,5 x 11 cm



L = 200/244 cm Polyurethane



C 754 · C 754F
5,6 x 5,6 cm



L = 200/244 cm Polyurethane

C 932 · C 932F
9,5 x 9,5 cm



L = 200/244 cm Polyurethane

C 728
7,7 x 4,3 cm



L = 200/244 cm Polyurethane

C 960
13 x 8 cm



L = 200/244 cm Polyurethane

C 931 · C 931F
7,5 x 7,7 cm



L = 200/244 cm Polyurethane

C 755
13 x 12 cm



L = 200/244 cm Polyurethane

C 701 · C 701F
7,9 x 5,2 cm



L = 200/244 cm Polyurethane

C 902 · C 902F
5,5 x 6 cm



C 785
6,3 x 6 cm



C 928 · C 928F
7,2 x 7,2 cm

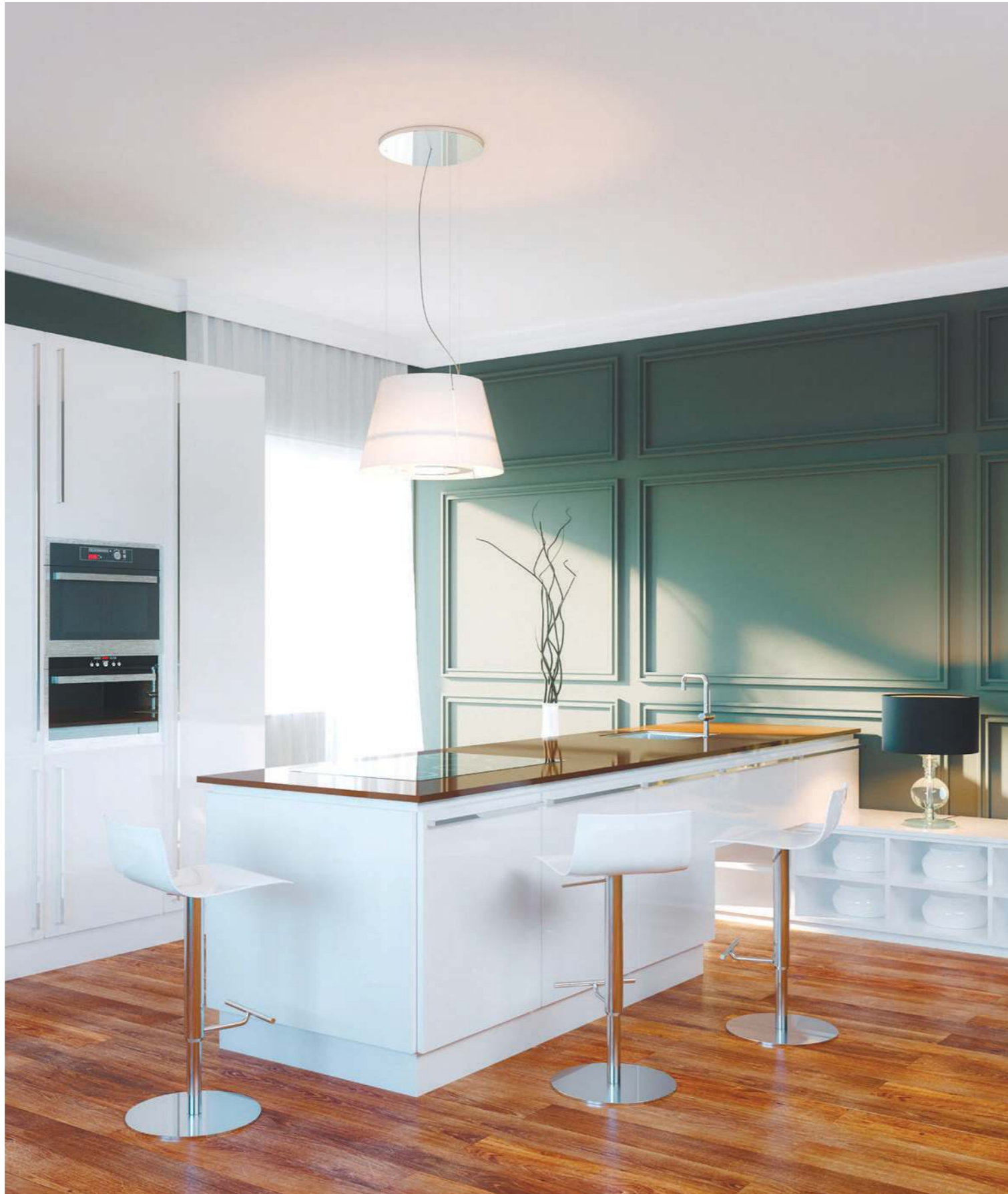

C 747
6,4 x 3 cm



C 777
9 x 9 cm



C 751
7,8 x 10,3 cm



C 921 · C 921F
11,5 x 7,5 cm



C 922 · C 922F
8 x 9,2 cm



C 730 · C 730F
8,2 x 11 cm



C 908 · C 908F
8,2 x 5,8 cm



C 773 · C 773F
7 x 7,5 cm



L = 200/244 cm Polyurethane

C 709
8,2 x 5,8 cm



L = 200/244 cm Polyurethane

C 731 · C 731F
9,2 x 9,2 cm



L = 200/244 cm Polyurethane

C 930 · C 930F
8,9 x 10 cm



L = 200/244 cm Polyurethane

C 724
11,4 x 5,4 cm



L = 200/244 cm Polyurethane



C 933
14 x 6,5 cm



L = 200/244 cm Polyurethane

C 771 · C 771F
10 x 7 cm



C 927
11 x 10,5 cm



C 926
19,5 x 14 cm

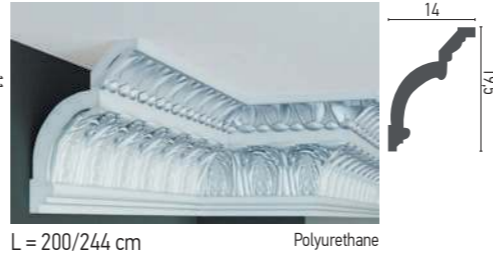

C 746 · C 746F
10,8 x 13,7 cm



C 914
11,6 x 11,1 cm



C 732
12,6 x 12,6 cm



C 758
12 x 11 cm



C 761
17 x 14,4 cm



C 775
14 x 7,8 cm



C 727 · C 727F
17,4 x 14 cm



C 734
18 x 12,4 cm



C 903
10 x 9,2 cm

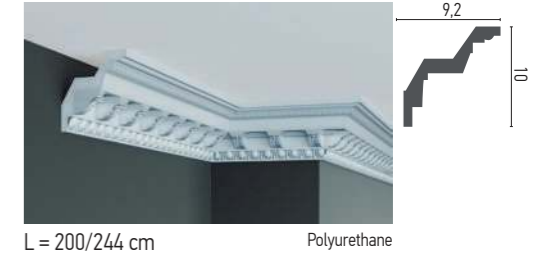

C 919
13,5 x 13,5 cm

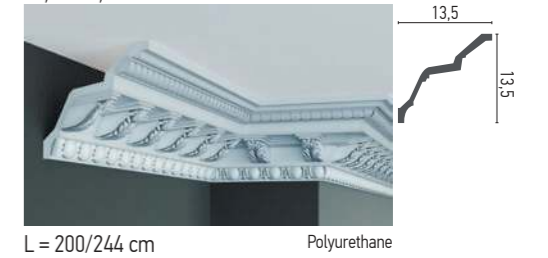

C 918
17 x 16 cm

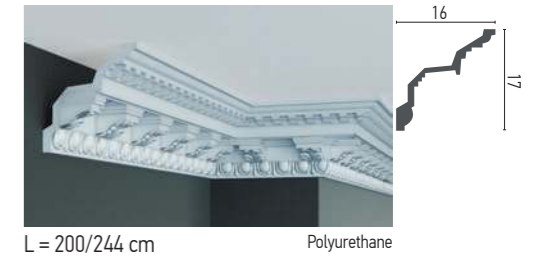

C 916
23 x 22 cm

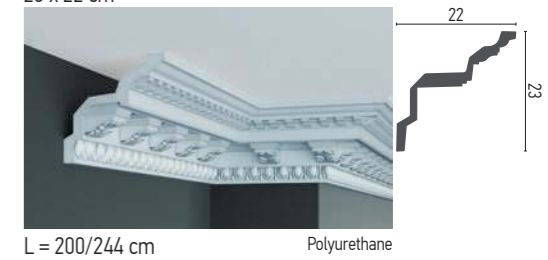



Wall moldings

CR 938 • CR 938F

2,3 x 1 cm

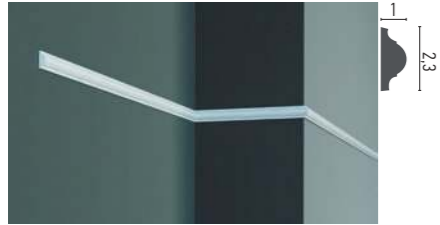

L = 200/244 cm

Polyurethane

CR 803 • CR 803F

2 x 0,8 cm

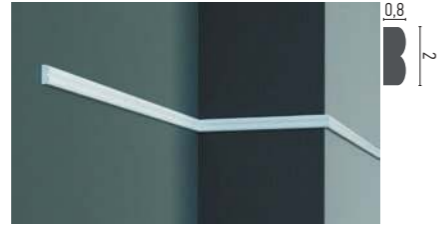

L = 200/244 cm

Polyurethane

CR 835 • CR 835F

1,9 x 1,1 cm



L = 200/244 cm

Polyurethane

CR 873 • CR 873F

4,9 x 2 cm



L = 200/244 cm

Polyurethane

CR 806 • CR 806F

6,8 x 2,3 cm



L = 200/244 cm

Polyurethane

CR 875 • CR 875F

2,5 x 1,1 cm



L = 200/244 cm

Polyurethane

CR 954 • CR 954F

2,1 x 1 cm

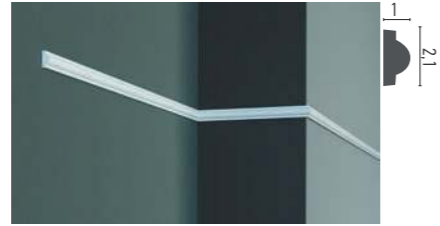

L = 200/244 cm

Polyurethane

CR 834 • CR 834F

2,3 x 1,3 cm



L = 200/244 cm

Polyurethane

CR 807 • CR 807F

5,4 x 1,5 cm



L = 200/244 cm

Polyurethane

CR 844 • CR 844F

9,4 x 3,3 cm



L = 200/244 cm

Polyurethane

CR 810 • CR 810F

4 x 1,8 cm



L = 200/244 cm

Polyurethane

CR 727 • CR 727F

2,4 x 1,3 cm



L = 200/244 cm

Polyurethane

CR 863 • CR 863F

3,4 x 1,5 cm



L = 200/244 cm

Polyurethane

CR 889 • CR 889F

6,2 x 2,6 cm



L = 200/244 cm

Polyurethane

CR 812 • CR 812F

10,3 x 4,1 cm



L = 200/244 cm

Polyurethane

CR 891

7,6 x 2,5 cm



L = 200/244 cm

Polyurethane

CR 963

8 x 2,6 cm



L = 200/244 cm

Polyurethane



CR 818 • CR 818F

4,3 x 2 cm



L = 200/244 cm

Polyurethane

CR 934 • CR 934F

6,5 x 2,1 cm



L = 200/244 cm

Polyurethane

CR 824 • CR 824F

4,2 x 1,8 cm



L = 200/244 cm

Polyurethane

CR 816 • CR 816F

8,2 x 2,2 cm



L = 200/244 cm

Polyurethane

CR 907 • CR 907F

3 x 1,8 cm



L = 200/244 cm Polyurethane

CR 939 • CR 939F

5 x 2,4 cm



L = 200/244 cm Polyurethane

CR 937 • CR 937F

8,5 x 2,5 cm



L = 200/244 cm Polyurethane

CR 910 • CR 910F

11 x 4,3 cm



L = 200/244 cm Polyurethane

CR 952 • CR 952F

8 x 2,1 cm



L = 200/244 cm Polyurethane



CR 911 • CR 911F

7,1 x 3,5 cm



L = 200/244 cm Polyurethane

CR 950 • CR 950F

10,1 x 3,3 cm



L = 200/244 cm Polyurethane

CR 964

15,5 x 5,4 cm



L = 200/244 cm Polyurethane

CR 960 • CR 960F

19,7 x 3,5 cm



L = 200/244 cm Polyurethane

CR 940

22 x 6,4 cm



L = 200/244 cm Polyurethane

CR 890

10 x 1,3 cm



L = 200/244 cm Polyurethane

CR 892

10,9 x 2 cm



L = 200/244 cm Polyurethane

CR 739 • CR 739F

7,5 x 2,1 cm



L = 200/244 cm Polyurethane

CR 779 • CR 779F

7,6 x 2 cm



L = 200/244 cm Polyurethane

CR 961 • CR 961F

11,4 x 2 cm



L = 200/244 cm Polyurethane





CR 915 • CR 915F

5 x 1,8 cm

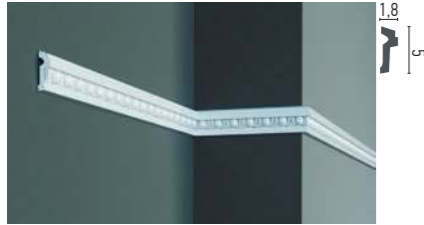

L = 200/244 cm

Polyurethane

CR 916 • CR 916F

2,4 x 1,1 cm

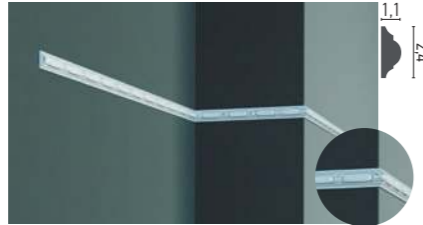

L = 200/244 cm

Polyurethane

CR 702 • CR 702F

7,7 x 1,9 cm

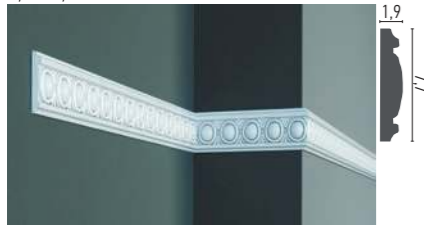

L = 200/244 cm

Polyurethane

CR 713 • CR 713F

3 x 1,4 cm



L = 200/244 cm

Polyurethane



CR 781 • CR 781F

5 x 0,6 cm

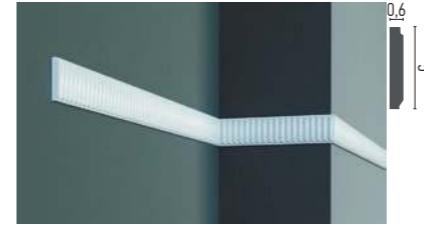

L = 200/244 cm

Polyurethane

CR 700 • CR 700F

1,7 x 0,8 cm

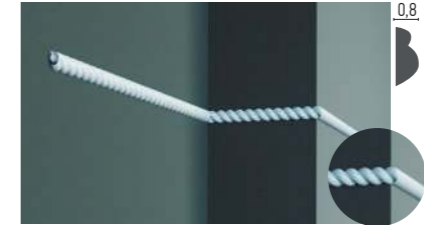

L = 200/244 cm

Polyurethane

CR 953 • CR 953F

8 x 1,8 cm



L = 200/244 cm

Polyurethane

CR 901

6 x 0,8 cm



L = 200/244 cm

Polyurethane

CR 912 • CR 912F

2,5 x 1,1 cm



L = 200/244 cm

Polyurethane

CR 955 • CR 955F

10,2 x 2,2 cm



L = 200/244 cm

Polyurethane

CR 736 • CR 736F

8,2 x 2,7 cm



L = 200/244 cm

Polyurethane

CR 930

2,7 x 1,9 cm



L = 200/244 cm

Polyurethane

CR 710

4 x 2,5 cm



L = 200/244 cm

Polyurethane

CR 707 • CR 707F

4,1 x 2,3 cm



L = 200/244 cm

Polyurethane



CR 785 • CR 785F

3,2 x 1,3 cm

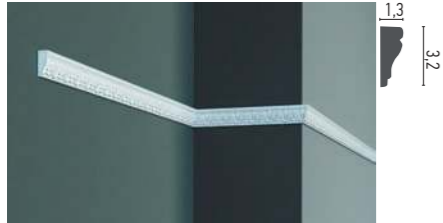

L = 200/244 cm

Polyurethane

CR 905

7,8 x 1,3 cm

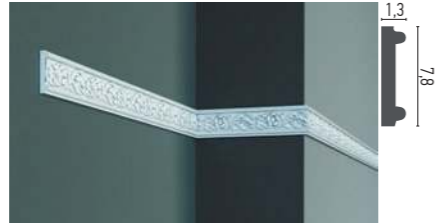

L = 200/244 cm

Polyurethane

CR 924

5 x 2 cm



L = 200/244 cm

Polyurethane

CR 732 • CR 732F

11 x 2 cm



L = 200/244 cm

Polyurethane

CR 742

6,1 x 3,3 cm



L = 200/244 cm

Polyurethane

CR 746 • CR 746F

12,8 x 1,4 cm



L = 200/244 cm

Polyurethane

CR 708 • CR 708F

13,8 x 4 cm



L = 200/244 cm

Polyurethane

CR 925

18 x 2,5 cm



L = 200/244 cm

Polyurethane

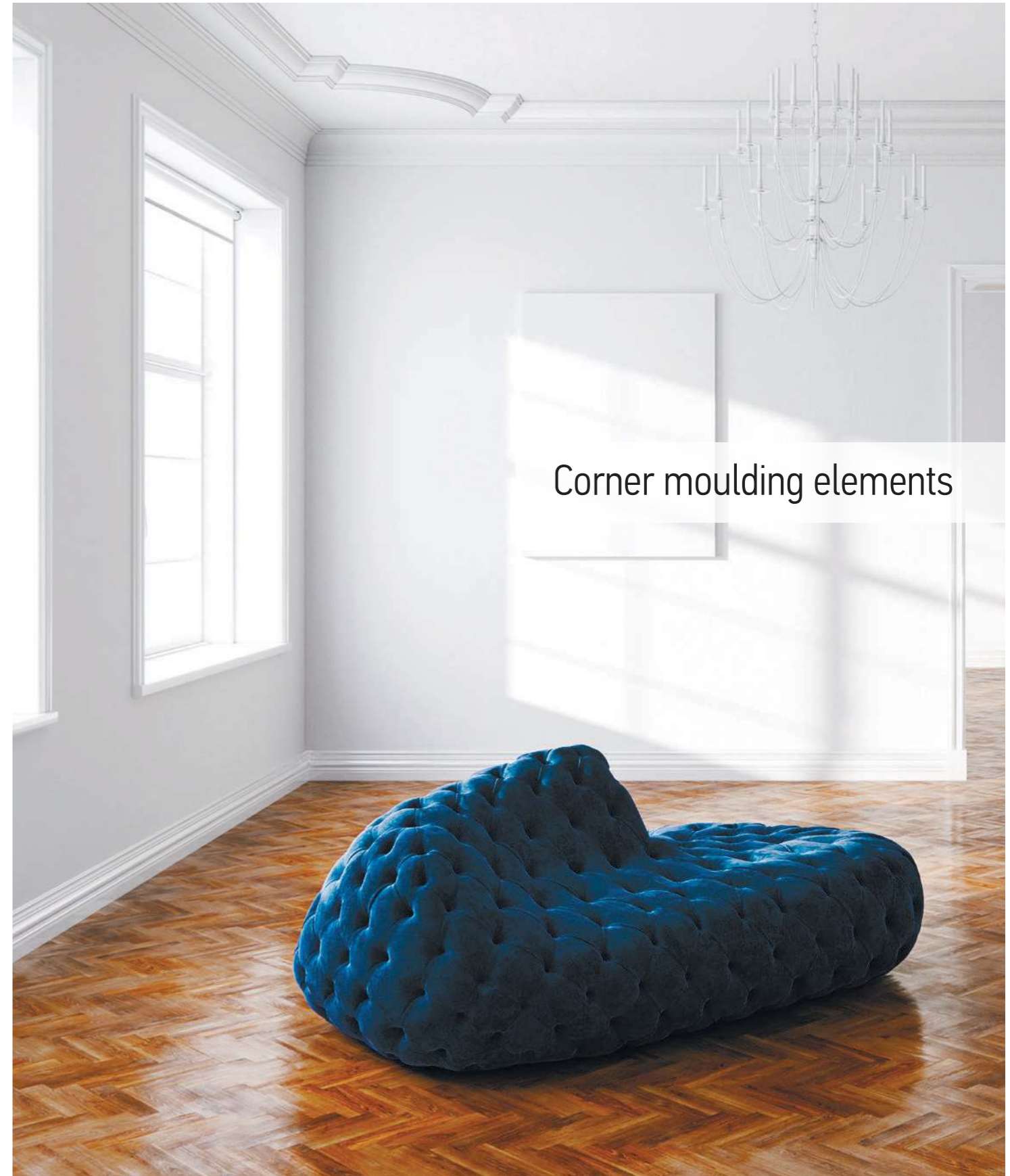

■ Corner moulding elements | ■ Winkелеlemente
■ Eléments d'angle | ■ Угловые элементы

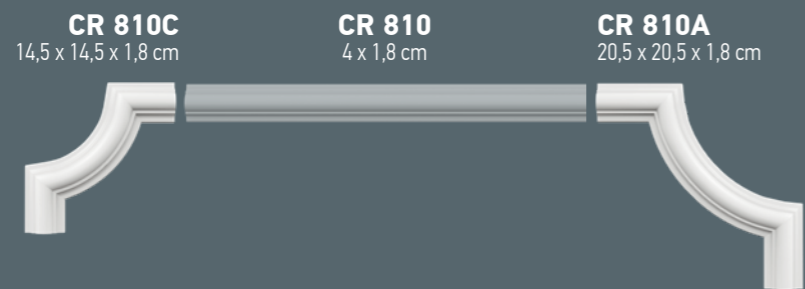
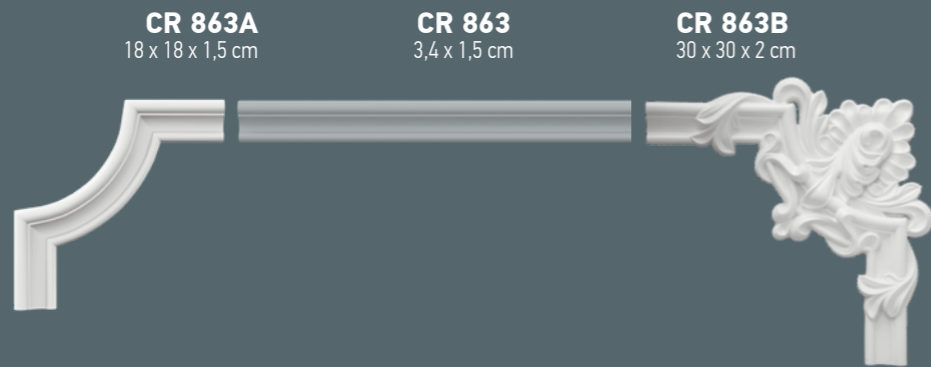

■ Corner moulding elements | ■ Winkелеlemente
■ Eléments d'angle | ■ Угловые элементы

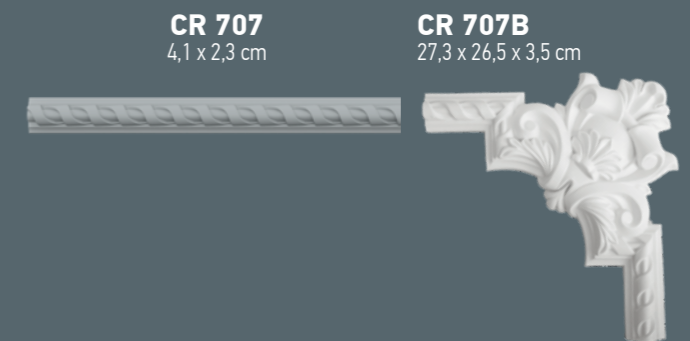
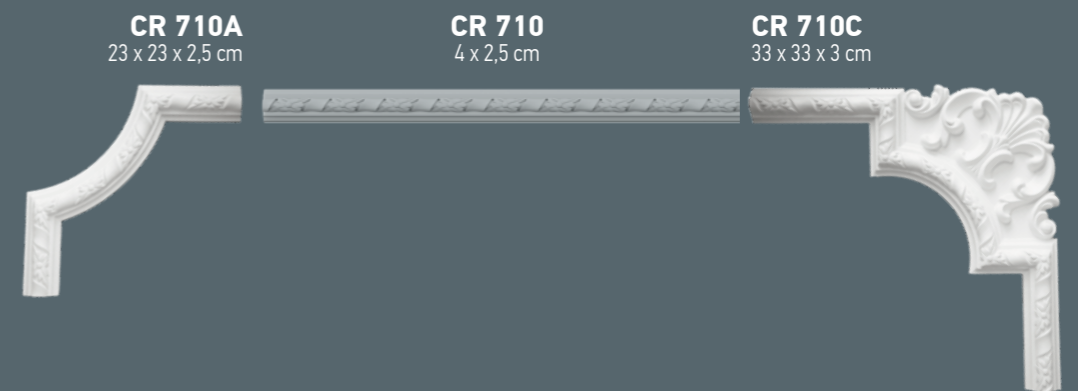
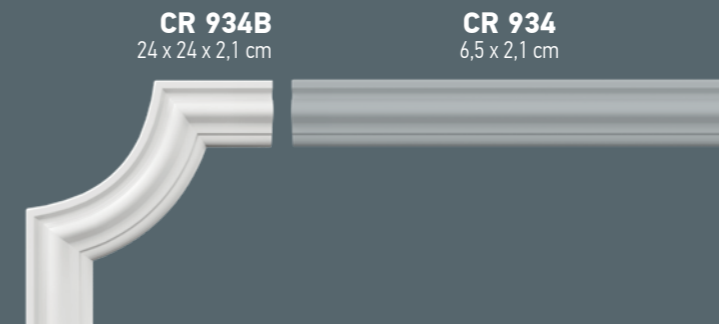
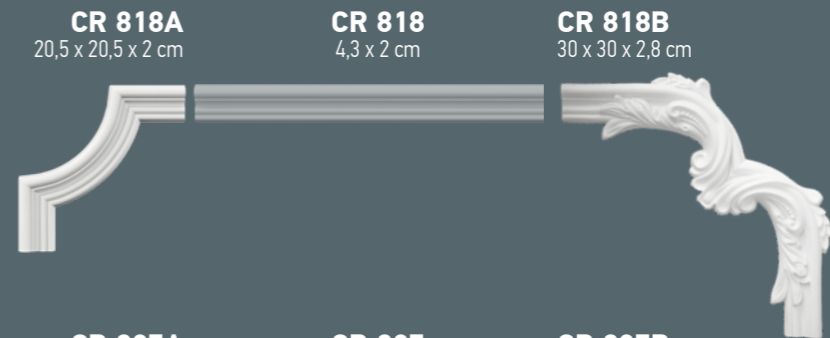

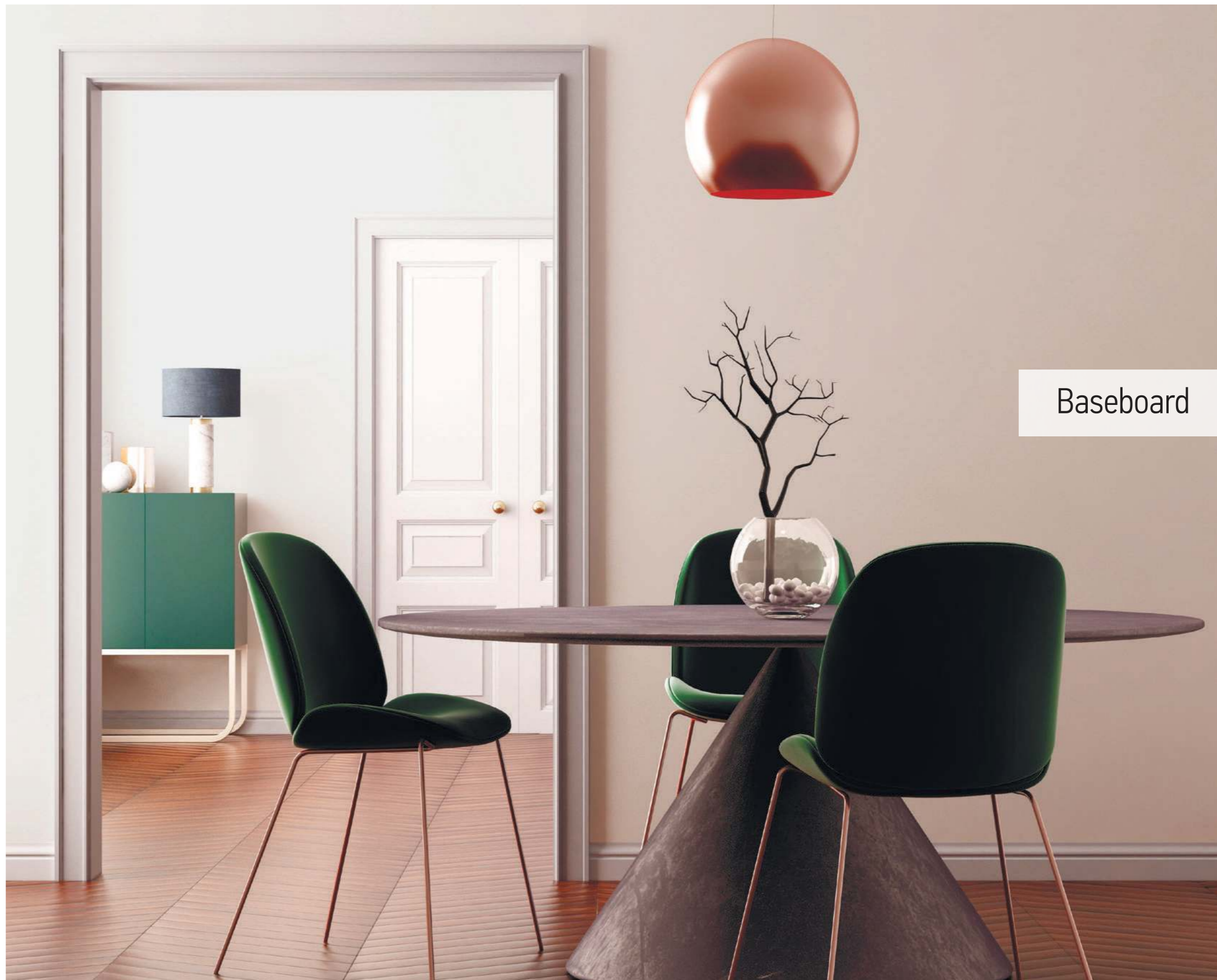

Baseboard

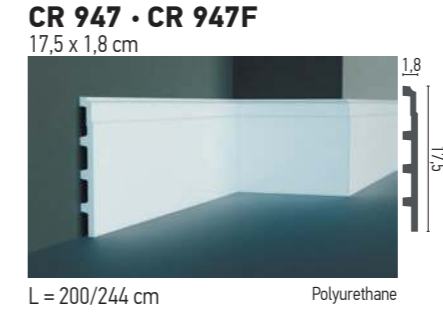







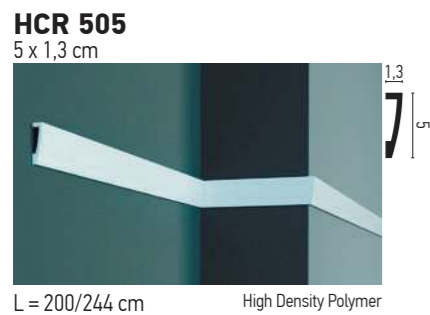

High density polymer

■ High Density Polymer | ■ Polymer mit hoher Dichte
■ Polymère haute densité | ■ Полимер высокой плотности



-  **Shockproof**
-  Easy to install
-  Wet fastness
-  Intelligent cleaning resistance
-  For painting any paints
-  Not subject to aging



*Best combination
this is the coincidence passion,
technology and creation*





*Create
atmosphere!*



*Details that
create your mood*





Inspiration



*Interior
Design
Details*



*Perfection and harmony, the result
of a combination of different forms*



*Attention to detail enhances
design uniqueness*





*We transform the room
into a stylish and comfortable space*



*Details that define
your personality*

*Combination of simple
and elegance*





Ceiling roses

R 128
∅ 30 cm | H: 3,2 cm



R 118
∅ 33,5 cm | H: 4,5 cm



R 115
∅ 20 cm | H: 4 cm



R 116
∅ 30 cm | H: 3,5 cm



R 179
∅ 32 cm | H: 4,2 cm



R 183
∅ 38 cm | H: 4,8 cm



R 184
∅ 37,5 cm | H: 4 cm



R 134
∅ 40 cm | H: 3,6 cm



R 103
∅ 41,5 cm | H: 4,5 cm



R 149
∅ 46 cm | H: 3,6 cm



R 127
∅ 47,5 cm | H: 4,8 cm



R 113
∅ 48,2 cm | H: 3,5 cm



R 180
∅ 53 cm | H: 4,2 cm



R 117
∅ 56 cm | H: 7,5 cm



R 109
∅ 49,5 cm | H: 5,8 cm



R 145
∅ 52,5 cm | H: 2,9 cm



R 148
∅ 57,5 cm | H: 2,7 cm



R 139
∅ 59,6 cm | H: 4,8 cm



R 182
∅ 61,7 cm | H: 5,5 cm



R 106
∅ 60 cm | H: 4,6 cm



R 123
∅ 60 cm | H: 3,1 cm



R 101
∅ 60 cm | H: 6 cm



R 105
∅ 66 cm | H: 6,5 cm



R 121
∅ 66,5 cm | H: 6,5 cm



R 137
∅ 67 cm | H: 5,5 cm



R 173
∅ 80 cm | H: 3,6 cm



R 107
∅ 83 cm | H: 5,2 cm



R 181
∅ 68 cm | H: 3,6 cm



R 124
∅ 72 cm | H: 6,1 cm



R 135
∅ 73,8 cm | H: 4,9 cm



R 189
∅ 89 cm | H: 6,2 cm



R 102
∅ 96,8 cm | H: 7,9 cm



R 108
∅ 76 cm | H: 4,5 cm



R 120
∅ 77 cm | H: 4,1 cm



R 185
∅ 80 cm | H: 5,8 cm



R 126
∅ 101 cm | H: 6,5 cm



R 114
31,5 x 60 cm | H: 4,5 cm



R 119
50 x 80 cm | H: 3,1 cm



R 161
73 x 108 cm | H: 2,5 cm



Ceiling rails



RL 735A
ER: 54,7 cm
IR: 50 cm
L1: 78,5 cm
L2: 85,9 cm

RL 736A
ER: 69,7 cm
IR: 65 cm
L1: 102,1 cm
L2: 109,5 cm

CR 873 · CR 873F
4,9 x 2 cm



L = 200/244 cm

Polyurethane



RL 896A
ER: 66,2 cm
IR: 60 cm
L1: 94,2 cm
L2: 103,9 cm

RL 897A
ER: 76,2 cm
IR: 700 cm
L1: 109,9 cm
L2: 119,7 cm

CR 889 · CR 889F
6,2 x 2,6 cm



L = 200/244 cm

Polyurethane



RL 601
ER: 44,4 cm
IR: 44,6 cm
L1: 69,9 cm
L2: 82,8 cm

CR 963
8 x 2,6 cm



L = 200/244 cm

Polyurethane

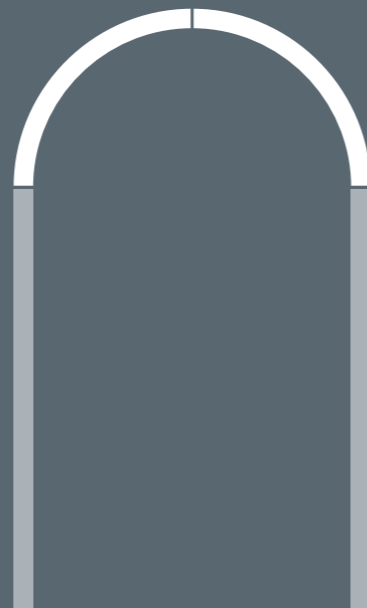

Panels



R 209
60,4 x 60,4 x 4 cm



Polyurethane



R 214
60,1 x 60,1 x 7,5 cm



Polyurethane



R 241
60,9 x 60,9 x 7,3 cm



Polyurethane



R 250
60,3 x 60,3 x 4 cm



Polyurethane



R 246
61,2 x 61,2 x 7,8 cm

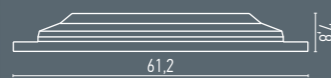

Polyurethane



Cupolas



DM 503
ED: 76 cm
ID: 57 cm
D: 11,5 cm
Polyurethane

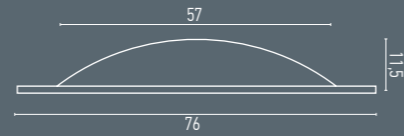

DM 507
ED: 115,5 cm
ID: 100,5 cm
D: 24 cm
Fibre Reinforced Plastic (FRP)

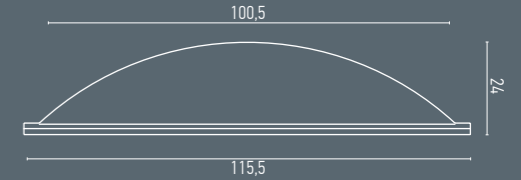

DM 508
ED: 113 cm
ID: 93 cm
D: 25 cm
Fibre Reinforced Plastic (FRP)

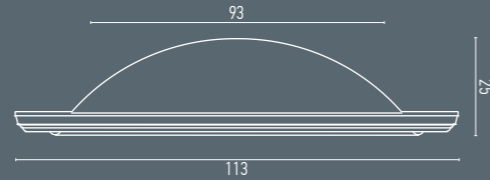

DM 502
ED: 122,5 cm
ID: 100,8 cm
D: 14 cm
Fibre Reinforced Plastic (FRP)

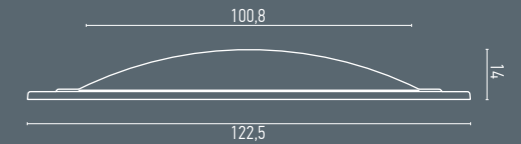

DM 504
ED: 113 cm
ID: 99,5 cm
D: 22 cm
Polyurethane

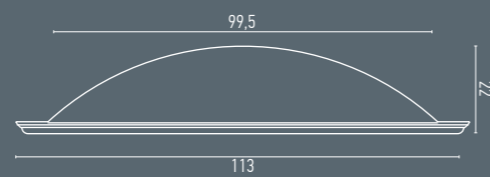

DM 506
ED: 122,5 cm
ID: 99,5 cm
D: 22 cm
Fibre Reinforced Plastic (FRP)

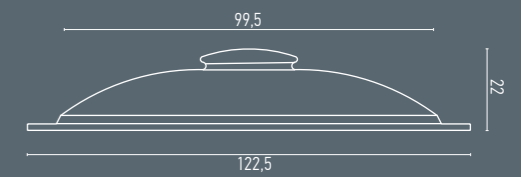

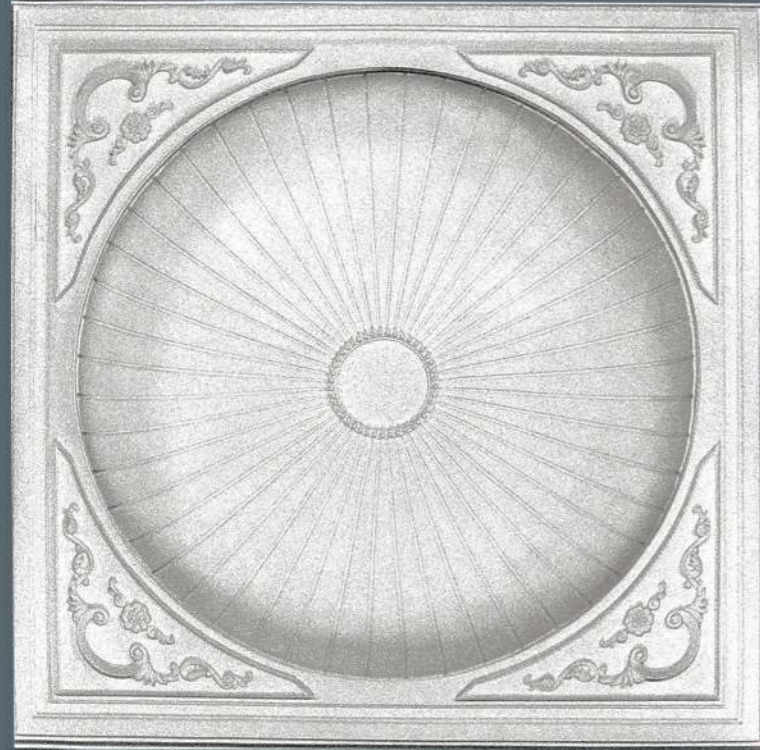

DM 501

ED: 122,5 cm

ID: 98 cm

D: 12,3 cm

Fibre Reinforced Plastic (FRP)

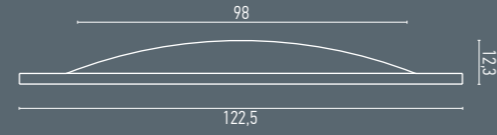

DM 512

ED: 202 cm

ID: 178 cm

D: 23,5 cm

Fibre Reinforced Plastic (FRP)

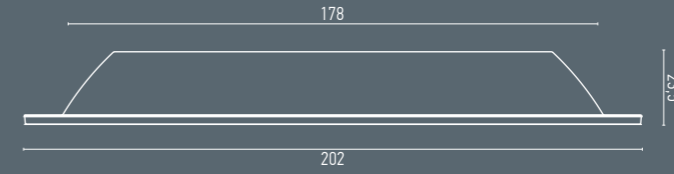

DM 505

ED: 146 cm

ID: 122 cm

D: 25 cm

Fibre Reinforced Plastic (FRP)

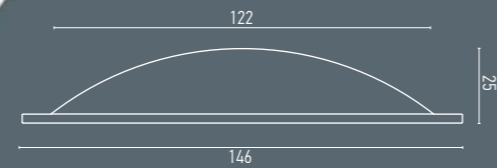

DM 513

ED: 204 cm

ID: 176 cm

D: 44,2 cm

Fibre Reinforced Plastic (FRP)

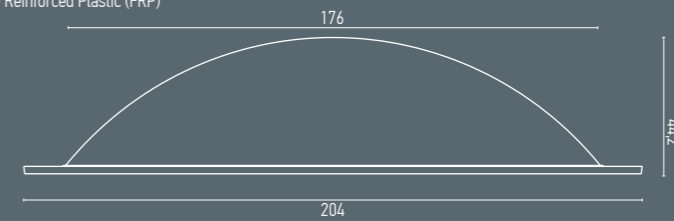



Door frames



D 419
123,5 x 25 x 9 cm



D 481
125 x 19,5 x 3,5 cm



D 481 + D489

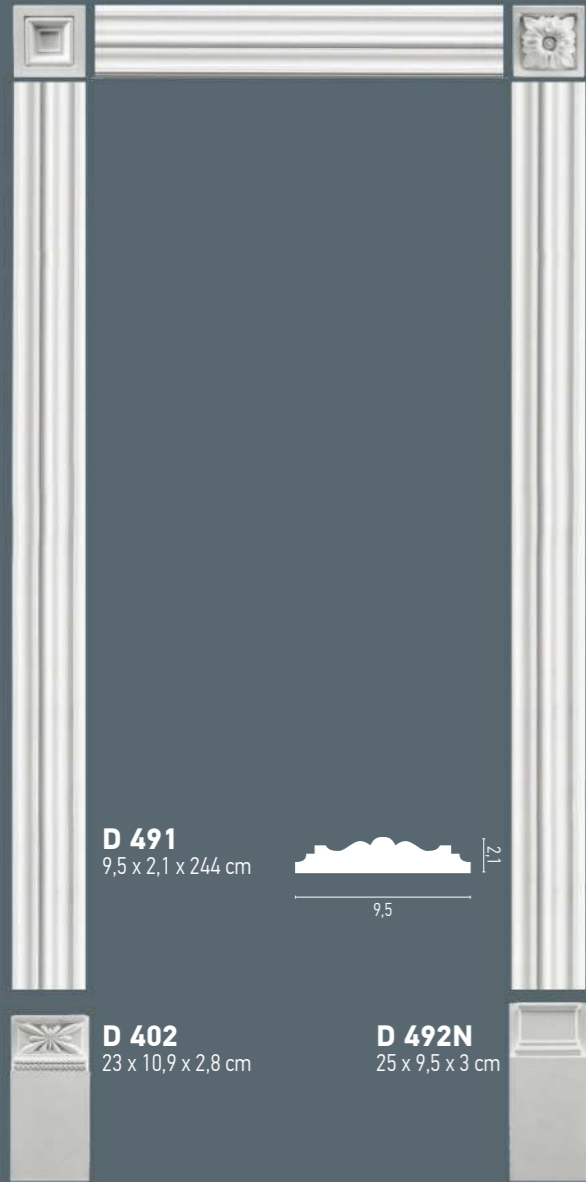

D 491
9,5 x 2,1 x 244 cm

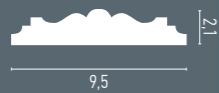

D 402
23 x 10,9 x 2,8 cm

D 492N
25 x 9,5 x 3 cm

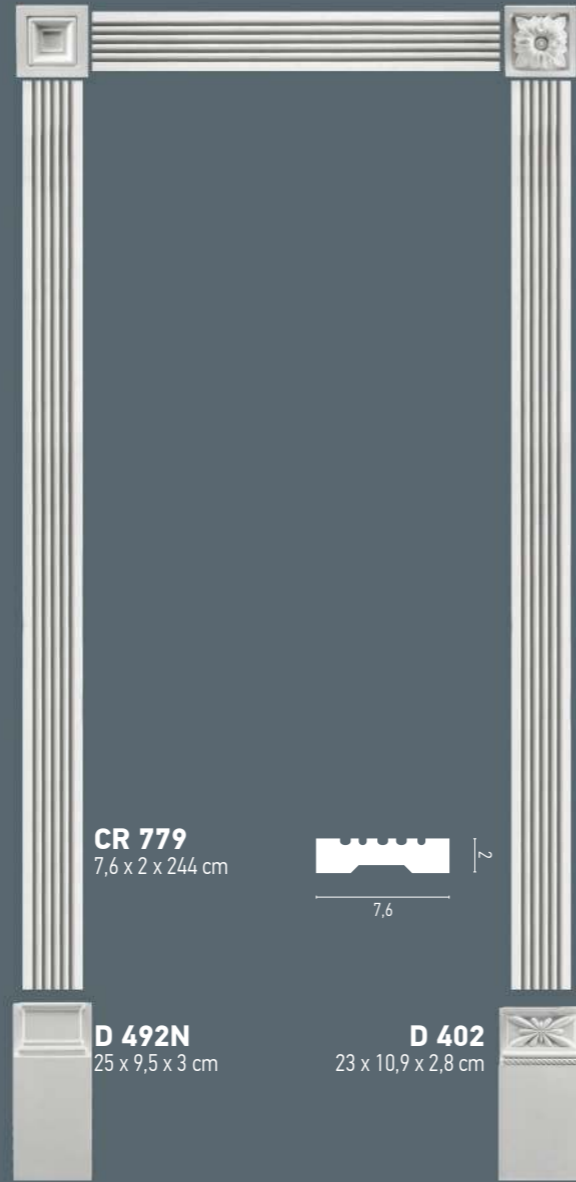

CR 779
7,6 x 2 x 244 cm



D 492N
25 x 9,5 x 3 cm

D 402
23 x 10,9 x 2,8 cm



D 480
9,4 x 3,3 x 244 cm



D 487 N
25,7 x 9,2 x 3,6 cm



D 490
9,5 x 9,5 x 4 cm



D 488
9,5 x 9,5 x 5 cm



D 493
9,5 x 9,5 x 2,5 cm



D 401
9 x 9 x 2,6 cm



D 400
11 x 11 x 2,8 cm



D 489
11,5 x 15,4 x 1,6 cm

D 402
23 x 10,9 x 2,8 cm



D 492N
25 x 9,5 x 3 cm



D 487N
25,7 x 9,2 x 3,6 cm





Pilasters

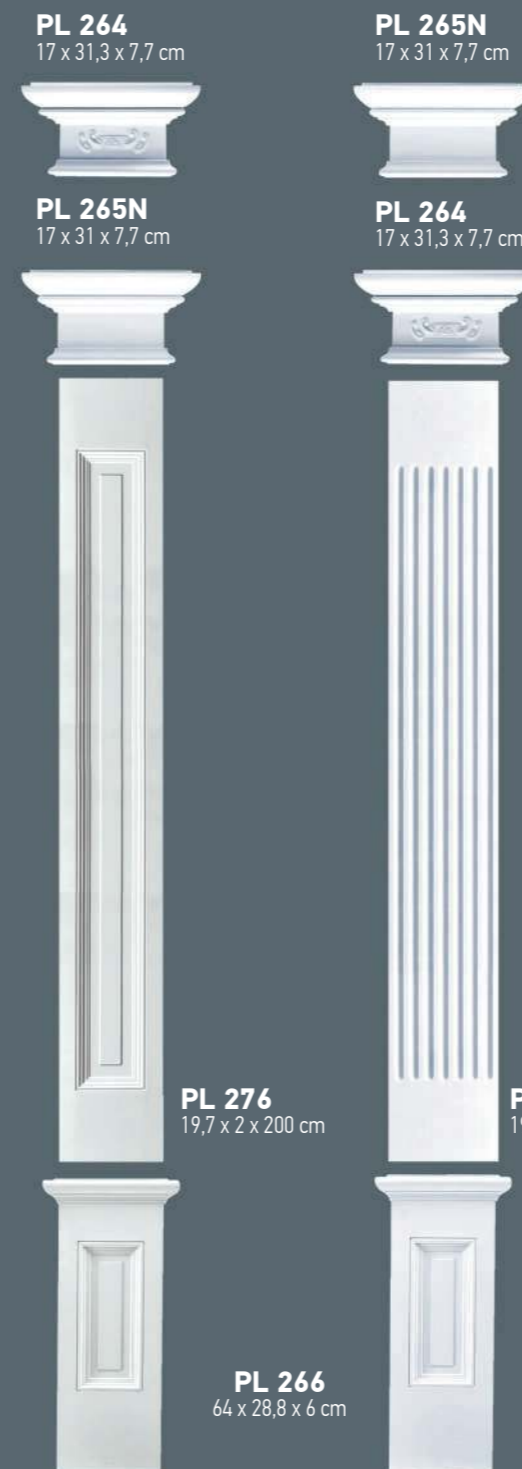
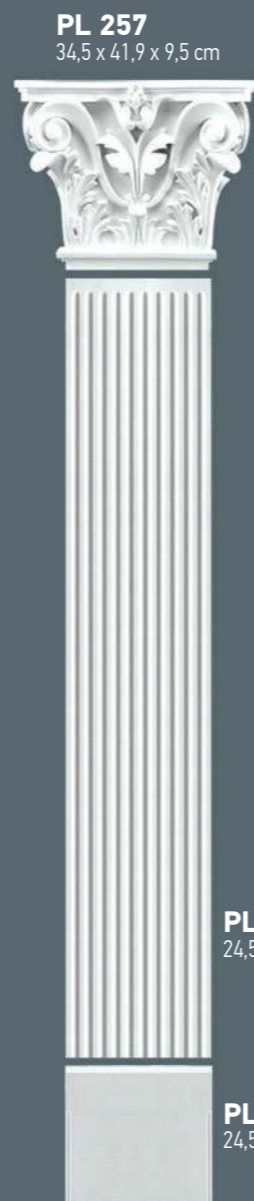
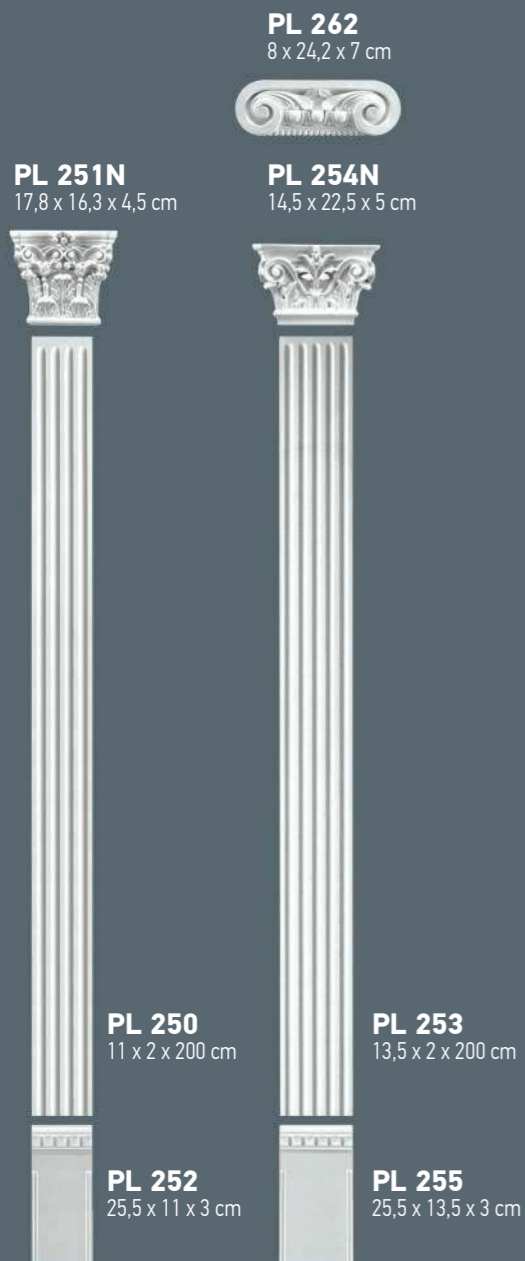

PL 262 + PL 253 + PL 255 = 233,5 cm
 PL 254N + PL 253 + PL 255 = 240,0 cm
 PL 251N + PL 250 + PL 252 = 243,3 cm
 PL 263 + PL 273 + PL 274 = 243,5 cm
 PL 279 + PL 273 + PL 274 = 252,5 cm
 PL 261 + PL 273 + PL 274 = 253,3 cm
 PL 257 + PL 270 + PL 271 = 259,0 cm





PL 258L/R + PL 253 + PL 255 = 244,4 cm
 PL 259L/R + PL 253 + PL 255 = 244,6 cm
 PL 265N + PL 276 + PL 266 = 281,0 cm
 PL 264 + PL 276 + PL 266 = 281,0 cm
 PL 264 + PL 275 + PL 266 = 301,0 cm
 PL 265N + PL 275 + PL 266 = 301,0 cm



Column

 $\varnothing=12\text{ cm}$
 $\varnothing=15\text{ cm}$
 $\varnothing=18\text{ cm}$
 $\varnothing=20\text{ cm}$



L 312F L 322H 15,5 x 22,8 cm  $\cdot 265\text{ cm}$	L 314F L 324H 20,7 x 29 cm  $\cdot 273,2\text{ cm}$	L 316F L 326H 24,5 x 33 cm  $\cdot 278,5\text{ cm}$	L 318F L 328H 25,7 x 37,5 cm  $\cdot 281,2\text{ cm}$
---	---	---	---



L 311F L 321H 8,5 x 23 cm  $\cdot 258\text{ cm}$	L 313F L 323H 10,5 x 26,5 cm  $\cdot 263\text{ cm}$	L 315F L 325H 11,5 x 30 cm  $\cdot 265,5\text{ cm}$	L 317F L 327H 12,5 x 36 cm  $\cdot 268\text{ cm}$
--	---	---	---



L 301F L 301H H = 239,5 cm	L 303F L 303H H = 239,5 cm	L 305F L 305H H = 239,5 cm	L 307F L 307H H = 239,5 cm
--	--	--	--



L 302F L 302H H = 239,5 cm	L 304F L 304H H = 239,5 cm	L 306F L 306H H = 239,5 cm	L 308F L 308H H = 239,5 cm
--	--	--	--



L 309F L 309H 10 x 20 cm	L 310F L 310H 13 x 24 cm	L 319F L 319H 14,5 x 28 cm	L 320F L 320H 16 x 31 cm
--	--	--	--

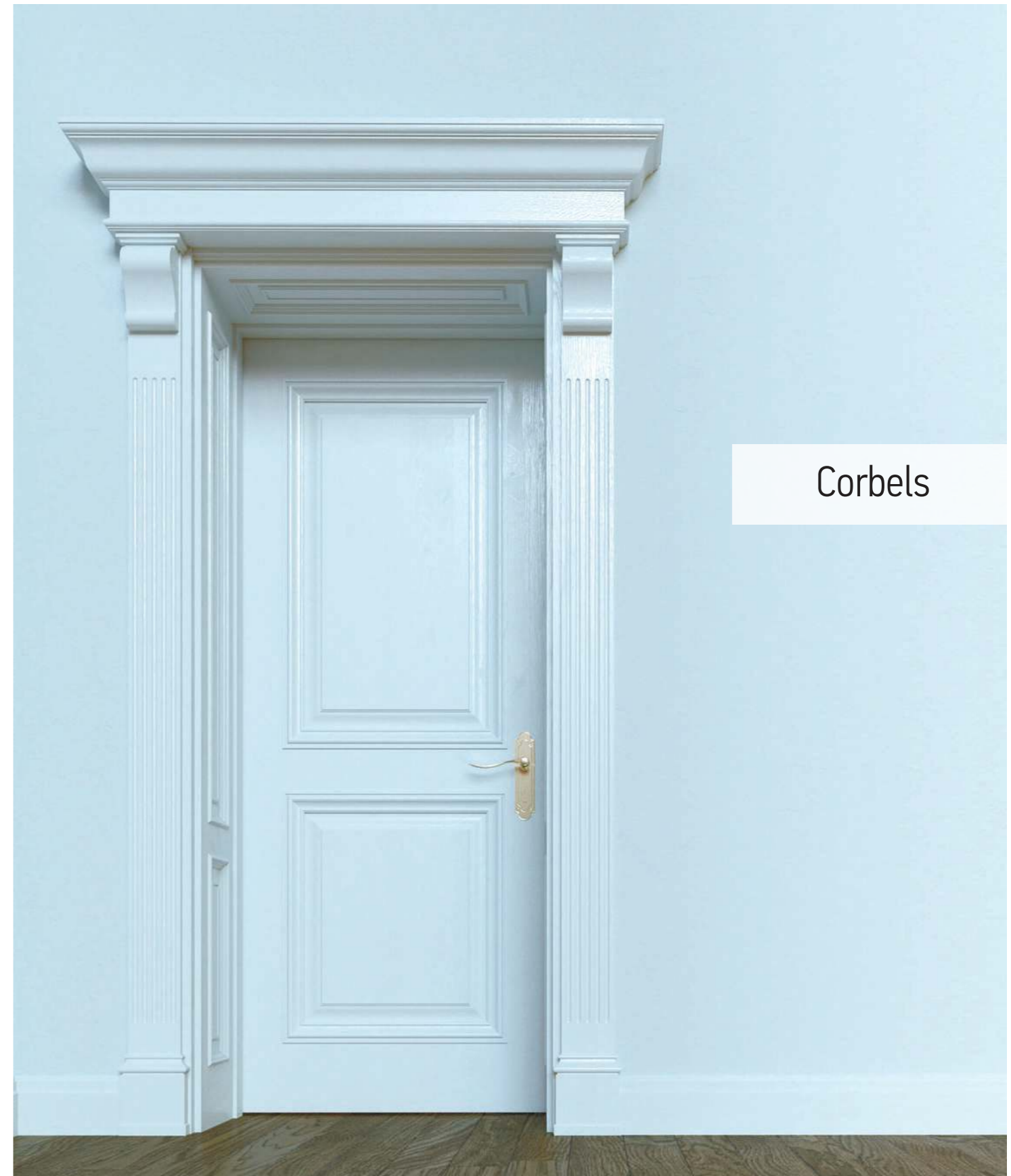

Corbels

B 024
10,9 x 8,8 x 4,3 cm



Polyurethane

B 072
12,8 x 7,3 x 3,5 cm



Polyurethane

B 021
14 x 11,5 x 7 cm



Polyurethane

B 023
14,1 x 10,1 x 6,5 cm



Polyurethane

B 062
25 x 16,8 x 12,2 cm



Polyurethane

B 015
26,9 x 15,6 x 5,5 cm



Polyurethane

B 030
45 x 14,5 x 11 cm



Polyurethane

B 022
14,3 x 10,7 x 6,7 cm



Polyurethane

B 033
13,6 x 9,5 x 5 cm



Polyurethane

B 032
14,9 x 10,8 x 6,9 cm



Polyurethane

B 064
16,8 x 11,4 x 7 cm



Polyurethane

B 077
31 x 13 x 7,5 cm



Polyurethane

B 063
31,4 x 14,3 x 14,5 cm



Polyurethane

B 078
18,5 x 7,7 x 15,1 cm



Polyurethane

B 066
19,1 x 18,5 x 9,8 cm



Polyurethane

B 065
20 x 7,2 x 6,5 cm



Polyurethane

B 076
23,8 x 8,8 x 5,8 cm



Polyurethane

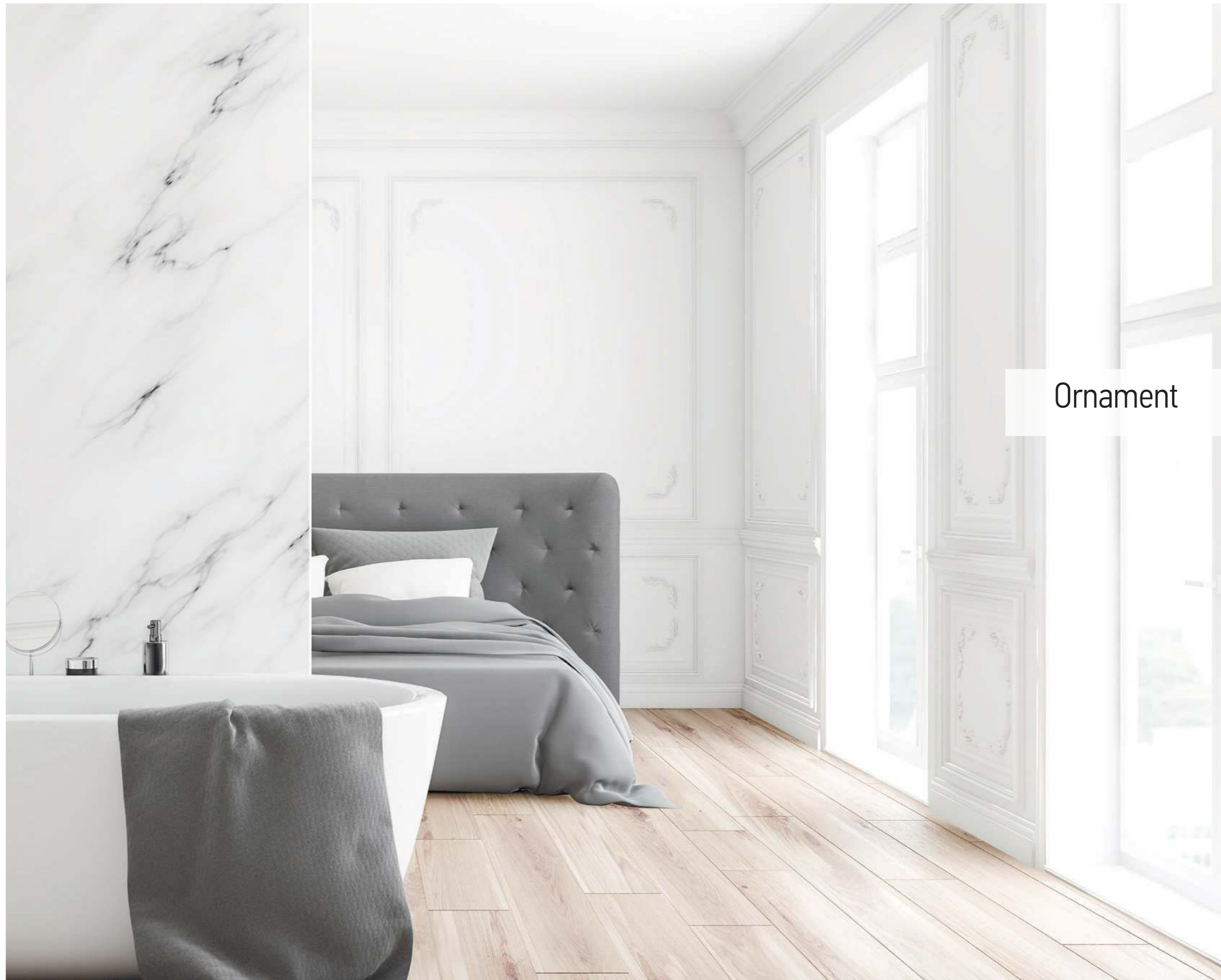

Ornament



W 815
8,5 x 21 x 2 cm



Polyurethane

W 810
8,3 x 21,7 x 2,5 cm



Polyurethane

W 863L W 863R
13,5 x 6,5 x 2,3 cm 13,5 x 6,5 x 2,3 cm



Polyurethane

W 813
11,5 x 7,9 x 1,3 cm



Polyurethane

W 817
22 x 15,2 x 2 cm



Polyurethane

W 864
33 x 13 x 2 cm



Polyurethane

A 608
18,5 x 24 x 2,5 cm



Polyurethane

A 857L A 857R
45,5 x 17,8 x 3 cm 45,5 x 17,8 x 3 cm



Polyurethane

A 874L
18,7 x 45,5 x 3,5 cm



A 875
27,5 x 30 x 2,5 cm



Polyurethane

A 874R
18,7 x 45,5 x 3,5 cm



W 862
31,5 x 20,5 x 3 cm



Polyurethane

A 856
13 x 64 x 3,5 cm



Polyurethane



Niches



N 134

- A: 64 cm
- B: 57 cm
- C: 45 cm
- D: 101,5 cm
- E: 132 cm
- F: 20,5 cm
- G: 33,5 cm
- H: 17 cm
- I: 33 cm

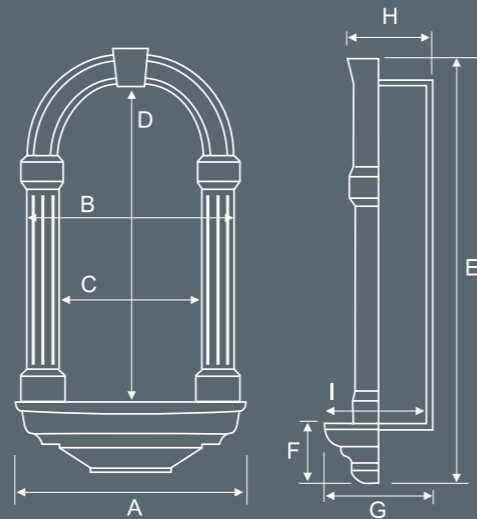

N 133A

- A: 42 cm
- B: 37,5 cm
- C: 26,5 cm
- D: 56 cm
- E: 76,5 cm
- F: 13,5 cm
- G: 20 cm
- H: 12,5 cm
- I: 19 cm

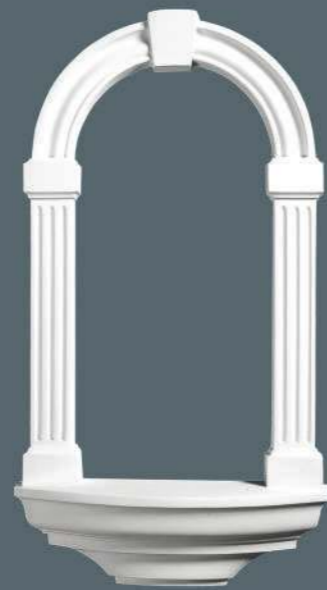

N 133

- A: 42 cm
- B: 37,5 cm
- C: 26,5 cm
- D: 56 cm
- E: 76,5 cm
- F: 13,5 cm
- G: 10,5 cm
- H: 3 cm

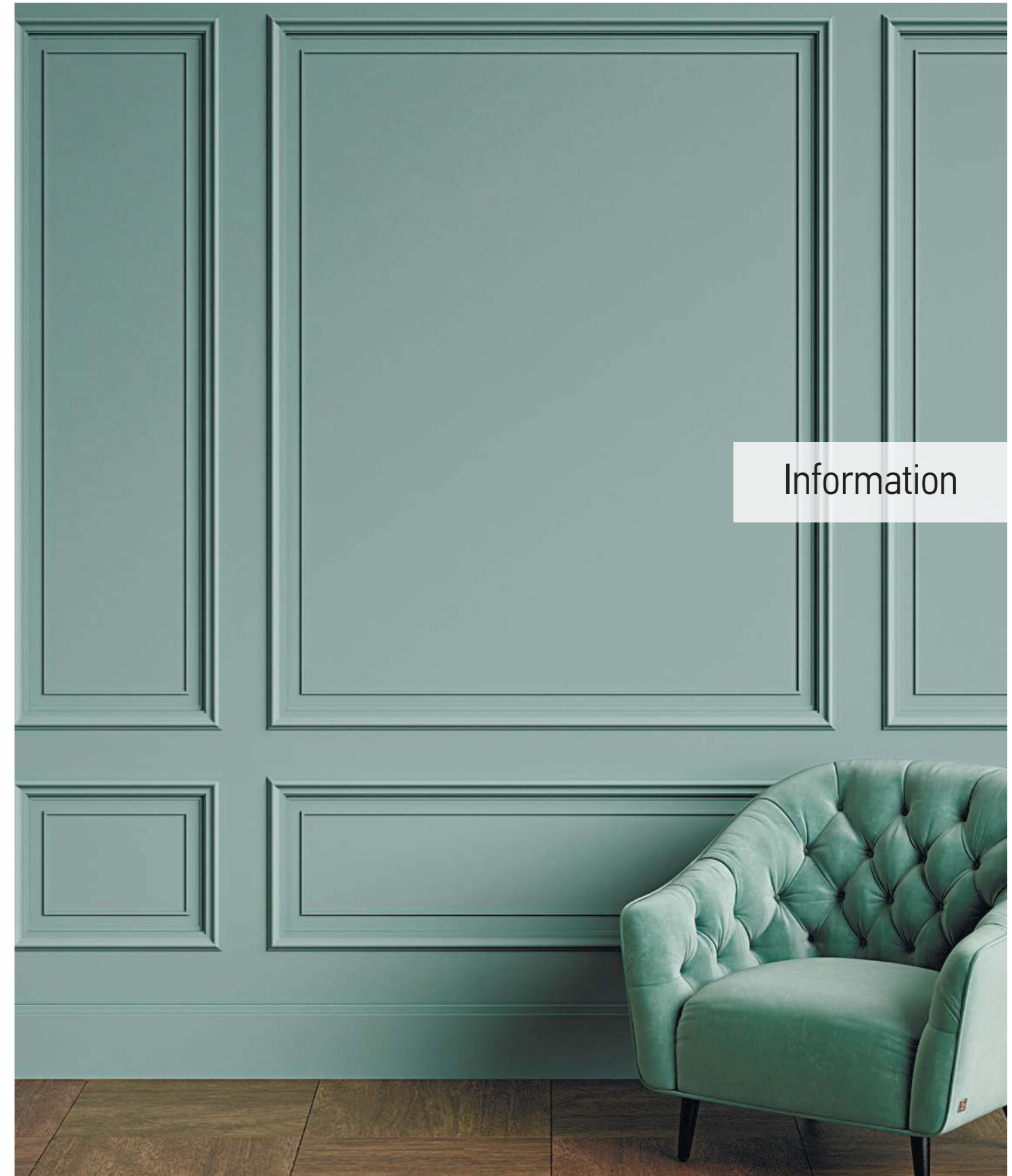

Information

POLYURETHANE

- Environmentally sensitive and modern material of high quality allowing you to build-up a complex and clear pattern.
- Polyurethane does not affect the ozone layer, does not contain freon, does not contain cyanides, does not contain asbestos.
- High quality material allowing you to build-up a complex and clear pattern.

FLEX

- Polyurethane-based material is suitable for creating of figurable linear components.
- Polyurethane-based material is suitable for using the components on flexible surfaces.
- Polyurethane-based material improves the flexibility to components, which in turn increases its scope of application in projects.

HIGH DENSITY POLYMER

- High density shock-resistant polymer.
- High density polymer coated with an additional protective layer and possessing high impact resistance coefficient.
- High density polymer coated with an additional impact resistant layer.

FIBERGLASS

- Fiberglass is fiber or filament made of glass or its derivatives, and due to the complex manufacturing process, it ultimately acquires unique properties indistinctive for regular glass. It is suitable for manufacturing large-sized components with clear patterns.
- This material allows the production of high-strength and large sizes components of low weight, complex configuration and clear pattern.



Make markings on the wall using a pencil to define the cornice location



Cut cornice with saw at a 45 degree angle.



Apply adhesive along the edges at the back of the cornice as well as the mating surface.



Join both cornices together, so that their profiles match. Use special adhesive to attach the items.



Ensure proper alignment on joints before nailing.



Apply filling knife to process the joints of cornices.



Use sand paper to smooth the surface.



Cover walls and ceiling with tape. Using brush, coat cornice with paint.

Before installation, stucco elements must be the same temperature as a room. For this, you have to leave them in a room for 24 hours.

Make sure that the walls and ceiling in the places of installation of the stucco elements are dry and clean, for more reliable gluing them with polyurethane.



SAMPLE BOX

A practical tool for presenting our products to customers. Sample Box includes the popular positions of cornices, baseboards and moldings.

Suitcase: 30 x 42 x 15,5 cm



ADVERTISING STAND

A tool to visually present our products to customers.

Stand dimensions: 170 x 40 x 13 cm

Flex Radius

Model	in, cm	out, cm	Model	in, cm	out, cm	Model	in, cm	out, cm	Model	in, cm	out, cm
C 701F	200	250	CR 875F	55	55	P 819F	150	200	P 928F	250	300
C 704F	200	250	CR 889F	55	55	P 820F	200	250	P 929F	200	200
C 731F	200	250	CR 899F	200	250	P 821F	150	200	P 930F	150	200
C 745F	150	250	CR 907F	55	55	P 822F	200	250	P 931F	100	150
C 746F	150	250	CR 910F	100	100	P 823F	250	300	P 932F	200	250
C 751F	200	250	CR 911F	55	55	P 824F	100	150	P 934F	250	300
C 754F	100	150	CR 912F	55	55	P 828F	200	250	P 935F	200	250
C 771F	250	300	CR 915F	100	150	P 829F	100	100	P 936F	100	150
C 773F	200	200	CR 916F	55	55	P 832F	250	300	P 937F	250	350
C 788F	250	300	CR 933F	55	55	P 833F	250	300	P 938F	100	150
C 902F	100	150	CR 934F	150	200	P 834F	250	300	P 940F	250	250
C 904F	200	250	CR 935F	55	55	P 836F	200	250	P 941F	100	150
C 908F	200	250	CR 936F	55	55	P 838F	250	300	P 942F	450	450
C 921F	250	300	CR 937F	55	55	P 848F	200	250	P 943F	200	250
C 922F	200	250	CR 938F	55	55	P 855F	150	200	P 944F	100	150
C 928F	200	200	CR 939F	55	55	P 856F	200	250	P 946F	200	250
C 930F	200	250	CR 941F	55	55	P 872F	200	250	P 949F	250	300
C 931F	200	200	CR 942F	55	55	P 876F	200	250	P 950F	250	350
C 932F	200	250	CR 943F	55	55	P 879F	100	100	P 951F	200	200
CR 700F	50	55	CR 945F	55	55	P 880F	450	450			
CR 702F	55	55	CR 946F	55	55	P 881F	200	250			
CR 707F	55	55	CR 947F	55	55	P 882F	350	350			
CR 708F	55	55	CR 950F	55	55	P 883F	250	300			
CR 713F	55	55	CR 952F	55	55	P 884F	250	300			
CR 727F	55	55	CR 953F	55	55	P 885F	250	300			
CR 732F	55	55	CR 954F	55	55	P 886F	200	200			
CR 736F	55	55	CR 955F	55	55	P 887F	300	400			
CR 739F	55	55	CR 960F	100	100	P 888F	450	450			
CR 746F	55	55	CR 961F	55	55	P 890F	250	300			
CR 779F	55	55	D 491F	55	55	P 894F	250	300			
CR 781F	55	55	P 801F	350	350	P 904F	200	250			
CR 785F	55	55	P 802F	250	300	P 905F	200	200			
CR 803F	55	55	P 803F	200	200	P 907F	150	250			
CR 806F	55	55	P 804F	250	300	P 908F	100	150			
CR 807F	55	55	P 805F	150	200	P 909F	150	250			
CR 810F	55	55	P 806F	250	300	P 910F	200	250			
CR 812F	55	55	P 807F	200	250	P 911F	200	250			
CR 816F	55	55	P 808F	150	200	P 914F	150	250			
CR 818F	55	55	P 809F	150	250	P 916F	150	250			
CR 824F	55	55	P 810F	150	200	P 918F	250	200			
CR 834F	55	55	P 811F	250	300	P 920F	100	150			
CR 835F	55	55	P 812F	150	200	P 921F	55	100			
CR 844F	100	100	P 813F	200	250	P 922F	200	250			
CR 863F	55	55	P 814F	150	200	P 923F	100	100			
CR 872F	55	55	P 816F	200	250	P 924F	250	250			
CR 873F	55	55	P 818F	200	250	P 927F	250	300			



Model	page	Model	page	Model	page	Model	page	Model	page	Model	page	Model	page	Model	page
C 701	33	P 812	19	P 921	19	L 319H	106	CR 785	50	CR 941	57	A 618R	113	R 105	84
C 702	32	P 813	18	P 922	11	L 320F	106	CR 803	42	CR 942	57	A 619	112	R 106	83
C 704	32	P 814	19	P 923	16	L 320H	106	CR 806	43	CR 943	57	A 620L	113	R 107	85
C 709	36	P 816	15	P 924	16	L 321F	106	CR 807	43	CR 945	57	A 620R	113	R 108	84
C 710	32	P 818	20	P 925	12	L 322F	106	CR 807A	53	CR 946	57	A 624	112	R 109	83
C 724	36	P 819	18	P 926	22	L 323F	106	CR 807B	53	CR 947	57	A 627L	113	R 113	83
C 725	32	P 820	19	P 927	16, 23	L 324F	106	CR 810	42	CR 950	45, 57	A 627R	113	R 114	86
C 727	38	P 821	12	P 928	14	L 325F	106	CR 810A	52	CR 951	46, 56	A 628	112	R 115	83
C 728	33	P 822	18	P 929	16	L 326F	106	CR 810B L	52	CR 952	44	A 639L	113	R 116	83
C 730	35	P 823	20	P 930	12	L 327F	106	CR 810B R	52	CR 953	48	A 639R	113	R 117	82
C 731	36	P 824	19	P 931	19	L 328F	106	CR 810C	52	CR 954	42	A 651	113	R 118	82
C 732	38	P 825	10	P 932	13	B 015	109	CR 810D insert	52	CR 954A	52	A 663	113	R 119	86
C 734	38	P 828	20	P 933	22	B 021	108	CR 812	43	CR 954B	52	A 671	113	R 120	84
C 738	32	P 829	19	P 934	16	B 022	108	CR 816	43	CR 955	48	A 672	112	R 121	84
C 745	32	P 832	15	P 935	15	B 023	108	CR 818	43	CR 956	46, 56	A 673	112	R 123	83
C 746	38	P 833	10	P 936	18	B 024	108	CR 818A	53	CR 957	46, 56	A 674L	113	R 124	84
C 747	35	P 834	16, 23	P 937	16, 23	B 030	109	CR 818B	53	CR 958	46, 56	A 674R	113	R 126	85
C 751	35	P 836	11	P 938	20	B 032	108	CR 824	43	CR 960	45, 57	A 677	113	R 127	83
C 754	33	P 837	22	P 940	14	B 033	108	CR 824A	52	CR 961	45	W 810	114	R 128	82
C 755	33	P 838	16, 23	P 941	8	B 062	109	CR 824B	52	CR 963	42	W 813	114	R 134	82
C 758	38	P 848	16	P 942	8	B 063	109	CR 834	43	CR 964	45	W 815	114	R 135	84
C 761	38	P 849	15	P 943	18	B 064	108	CR 835	43	HCR 501	62	W 817	114	R 137	84
C 771	38	P 855	16, 23	P 944	8	B 065	108	CR 844	43	HCR 502	62	W 856	114	R 139	83
C 773	36	P 856	10	P 946	20	B 066	108	CR 863	43	HCR 503	62, 63	W 857L	114	R 145	83
C 775	38	P 857	15	P 947	10	B 072	108	CR 863A	52	HCR 504	62, 63	W 857R	114	R 148	83
C 777	35	P 872	11	P 949	10	B 076	108	CR 863B	52	HCR 505	62, 63	W 862	114	R 149	83
C 785	34	P 876	19	P 950	20	B 077	109	CR 872	46, 56	HCR 506	62, 63	W 863L	114	R 161	86
C 788	32	P 879	8	P 951	19	B 078	108	CR 873	43	HCR 507	63	W 863R	114	R 173	85
C 902	34	P 880	8	L 301F	106	DM 501	94	CR 875	42	HCR 508	63	W 864	114	R 179	83
C 903	39	P 881	21	L 301H	106	DM 502	93	CR 889	43	HCR 509	63	W 874L	114	R 180	82
C 904	32	P 882	21	L 302F	106	DM 503	92	CR 890	45	HCR 510	63	W 874R	114	R 181	84
C 908	35	P 883	21	L 302H	106	DM 504	92	CR 891	42	HCR 511	63	W 875	114	R 182	82
C 914	38	P 884	21	L 303F	106	DM 505	94	CR 892	45	D 400	99	PL 250	102	R 183	83
C 916	39	P 885	21	L 303H	106	DM 506	93	CR 893	46, 56	D 401	99	PL 252	102	R 184	82
C 918	39	P 886	14	L 304F	106	DM 507	93	CR 899	46, 57	D 402	99	PL 253	102, 103	R 185	84
C 919	38	P 887	14, 22	L 304H	106	DM 508	92	CR 901	48	D 419	99	PL 255	102, 103	R 189	85
C 921	35	P 888	8	L 305F	106	DM 512	95	CR 905	50	D 480	99	PL 257	102	RL 601	88
C 922	35	P 889	26	L 305H	106	DM 513	95	CR 907	44	D 481	99	PL 258L	103	RL 735A radius	88
C 926	38	P 890	26	L 306F	106	CR 700	48	CR 910	44	D 488	99	PL 258R	103	RL 736A radius	88
C 927	38	P 891	26	L 306H	106	CR 702	48	CR 911	45	D 489	99	PL 259L	103	RL 896A radius	88
C 928	34	P 892	19	L 307F	106	CR 707	48	CR 912	48	D 490	99	PL 259R	103	RL 897A radius	88
C 930	36	P 893	12	L 307H	106	CR 707B	53	CR 915	48	D 491	98	PL 261	102	R 209	90
C 931	33	P 894	26	L 308F	106	CR 708	50	CR 916	48	D 492N	98, 99	PL 262	102	R 214	90
C 932	33	P 895	26	L 308H	106	CR 710	48	CR 924	50	D 493	99	PL 263	102	R 241	90
C 933	37	P 902	20	L 309F	106	CR 710A	53	CR 925	50	D 487N	99	PL 264	103	R 246	90
C 960	33	P 904	12	L 309H	106	CR 710C	53	CR 930	48	N 133	116	PL 265N	103	R 250	90
P 801	18	P 905	16	L 310F	106	CR 713	48	CR 931	46, 56	N 133A	116	PL 266	103		
P 802	20	P 907	8	L 310H	106	CR 727	42	CR 932	46, 56	N 134	116	PL 270	102		
P 803	13	P 908	18	L 311F	106	CR 727A	52	CR 933	57	A 602	112	PL 271	102		
P 804	20	P 909	20	L 312F	106	CR 727B	52	CR 934	43	A 608	114	PL 273	102		
P 805	19	P 910	13	L 313F	106	CR 732	50	CR 934B	53	A 611L	113	PL 274	102		
P 806	16	P 911	18	L 314F	106	CR 736	48	CR 935	57	A 611R	113	PL 275	103		
P 807	13	P 914	16	L 315F	106	CR 739	45	CR 936	57	A 612	113	PL 276	103		
P 808	16	P 916	16	L 316F	106	CR 742	50	CR 937	44	A 613	112	PL 279	103		
P 809	19	P 918	20	L 317F	106	CR 746	50	CR 938	42	A 614	112	R 101	83		
P 810	18	P 919	17	L 318F	106	CR 779	45, 100	CR 939	44	A 616	112	R 102	85		
P 811	17	P 920	22	L 319F	106	CR 781	48	CR 940	45	A 618L	113	R 103	83		

DESIGN

Oleksandr Riabov

ART IDEA

Natalia Somina

3D DESIGNER

Yana Samoilenko

Maria Taranova

TECHNICAL SPECIALIST

Tetyana Lutsenko

PICTURE

Shutterstock® (www.shutterstock.com)

Depositphotos® (depositphotos.com)

Cgtrader® (www.cgtrader.com)

PRINT

Advertising Agency Alternative (Kyiv, Ukraine).

5000 copy (01.2020)



