

# 620









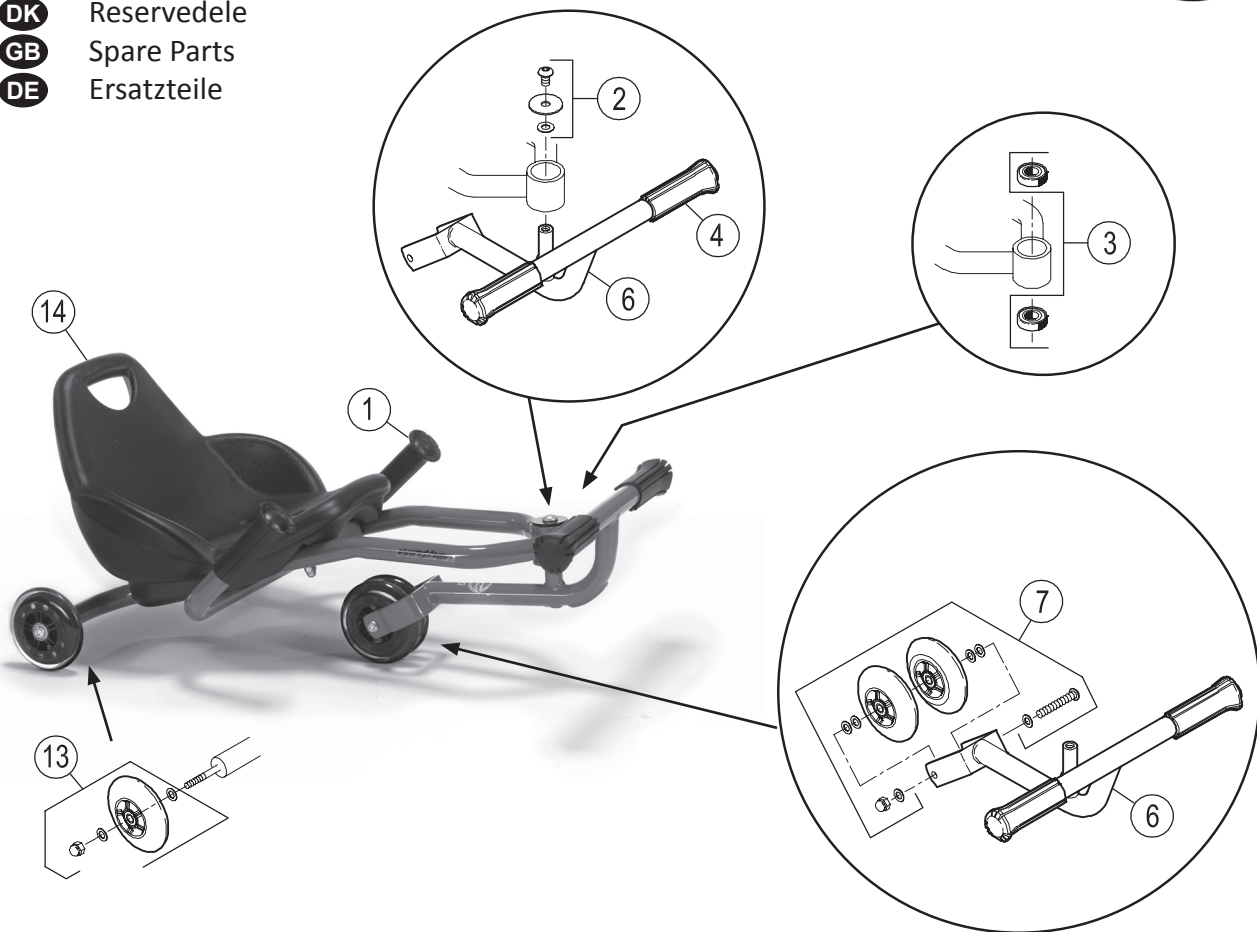







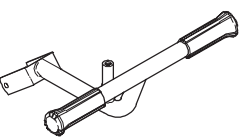





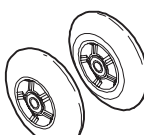



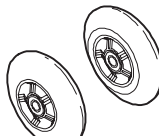

# EN 71

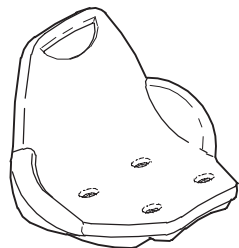

- DK** Reservedele
- GB** Spare Parts
- DE** Ersatzteile



Pos.		Pos.	
1	 x2	8	
2	 x1  x1  x1	9	
3	 x2	10	
4	 x2	11	
5		12	
6	     	7	     
13	    	14	    



# 620



EN 71



- DK** Reservedele
- GB** Spare Parts
- DE** Ersatzteile

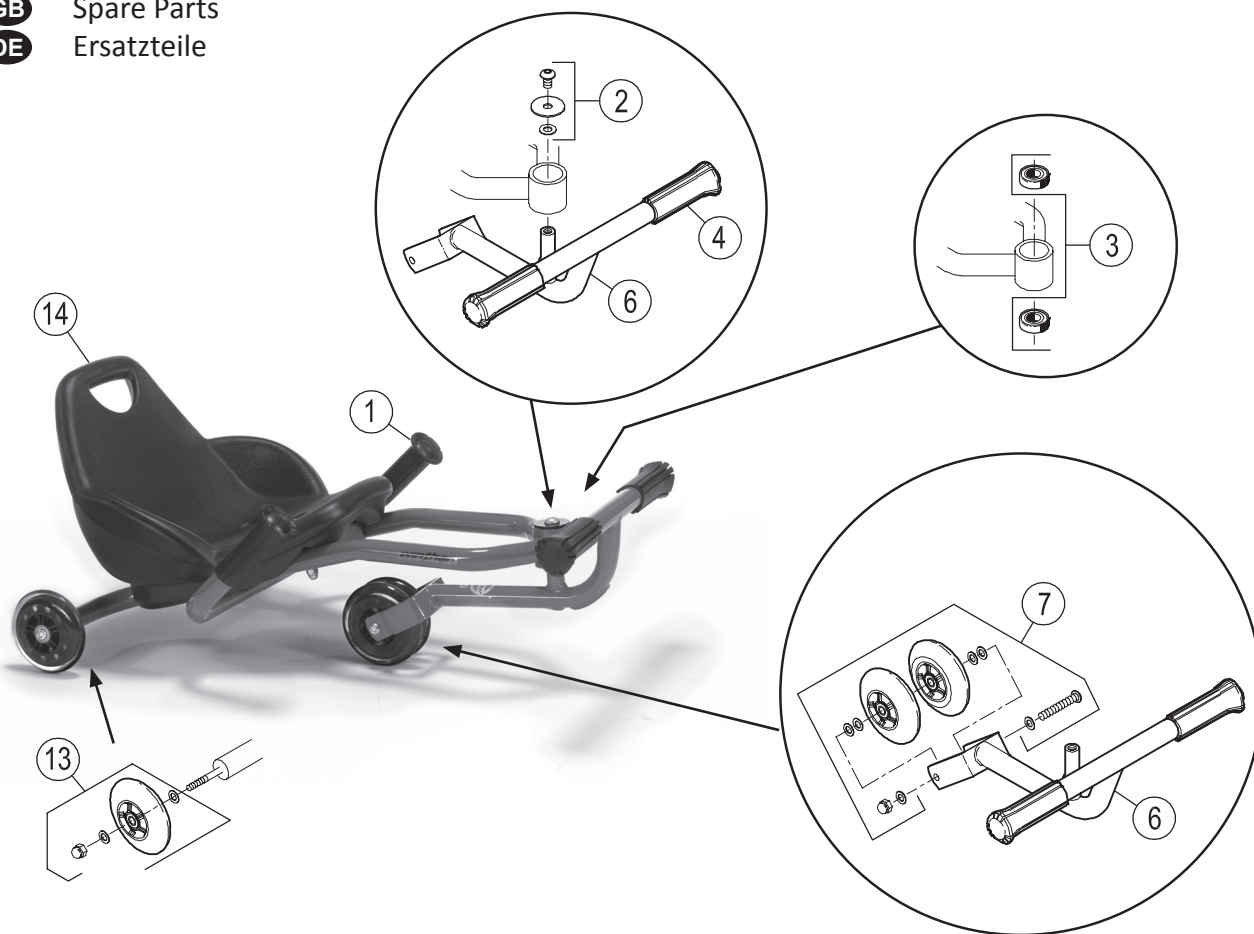

620.00					
Version					
Pos.	1.0				
1	50403				
2	50488				
3	50489				
4	50902				
5	-				
6	50490				
7	50491				
8	-				
9	-				
10	-				
11					
12	-				
13	50492				
14	50493				
15	-				
16	-				
17	-				
18	-				

