

KRISHNA / TOBOL / SANKURA / CHERLEN

RECESSED PROFILES



scissors



hacksaw



glue



drill



screwdriver



metal shears



cotton gloves



spatula

profiles

endings

mountings



04 LED profile KRISHNA

04



05 LED profile TOBOL

05



06 LED profile SANKURA

06



07 LED profile CHERLEN

07



U9 mounting plate



cone U9 mounting plate



rack U9 mounting plate



spring U9 mounting plate

**KRISHNA
TOBOL
diffuser**
A9, C9, D9, E9

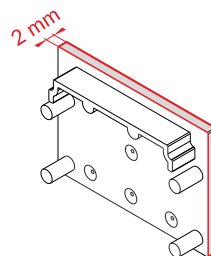
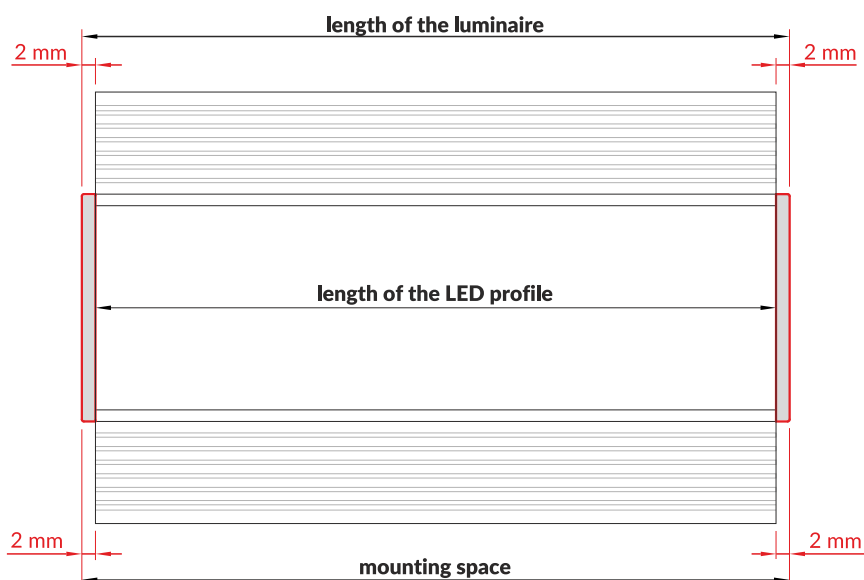

**SANKURA,
CHERLEN
diffuser**
A9, C9, D9, E9

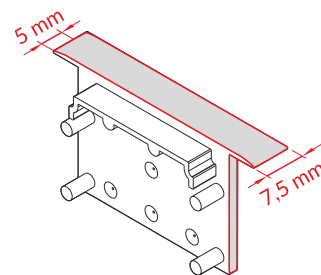
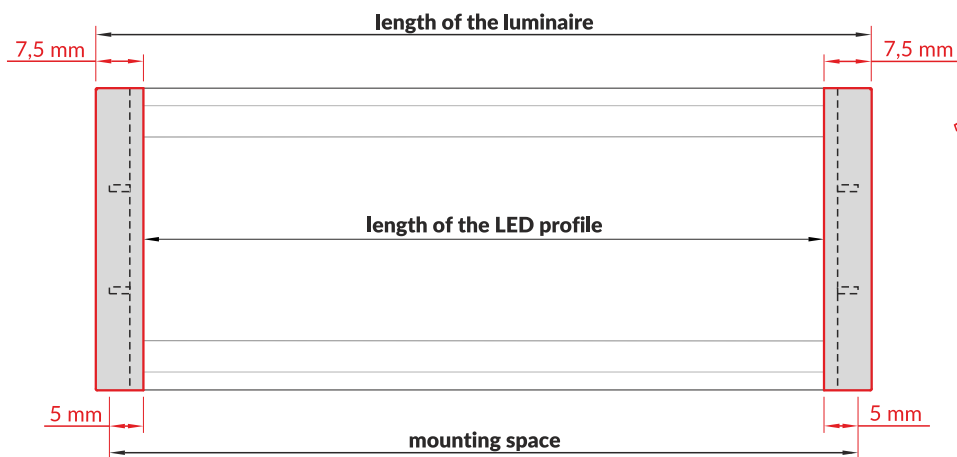

**KRISHNA
TOBOL
SANKURA
CHERLEN
diffuser**
A9, C9, D9, E9

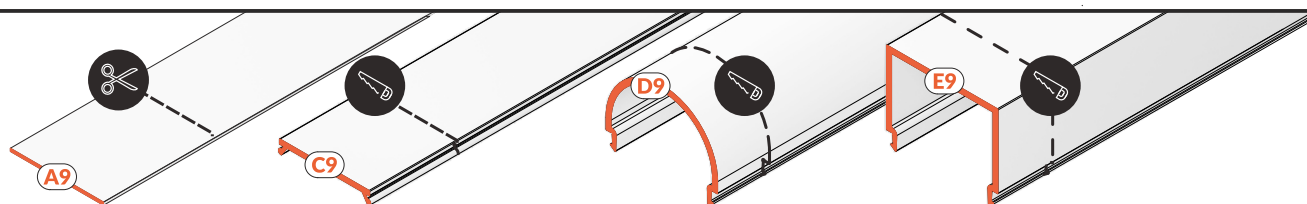

Note! The length of the cover is equal to the length of the profile.

III

**KRISHNA
TOBOL
SANKURA
CHERLEN**
diffuser
A9, C9, D9, E9

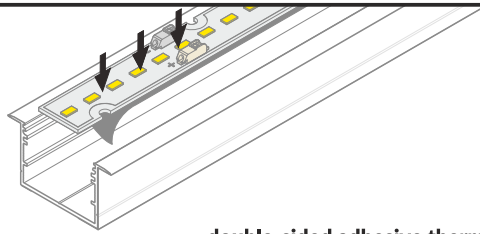

double-sided adhesive thermally
conductive tape 15 mm x 50 m

IV ACCESSORIES

KRISHNA / SANKURA | LED CLAMP

**KRISHNA
SANKURA**
diffuser
A9, C9, D9, E9

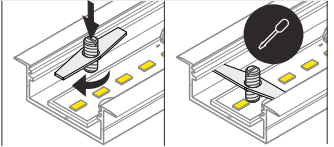
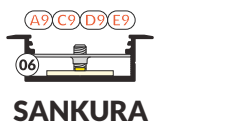
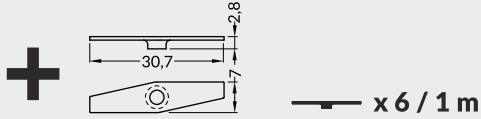

TOBOL / CHERLEN | LED mounting TOBOL / CHERLEN | LED clamp

**TOBOL
CHERLEN**
diffuser
A9, C9, D9, E9

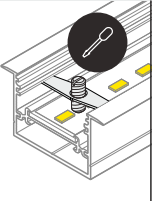
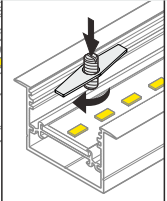
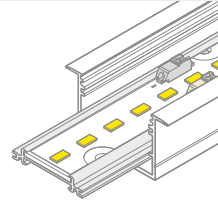
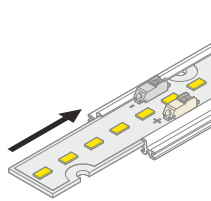
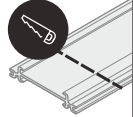
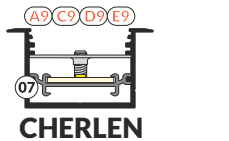
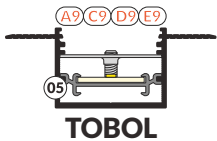
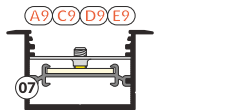
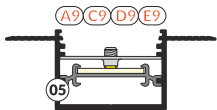
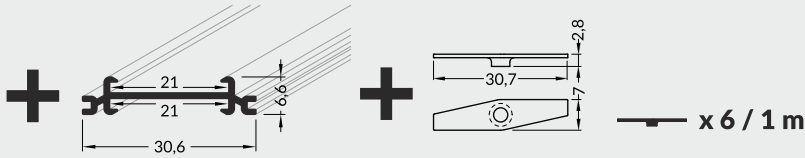

TOBOL / CHERLEN | LED 1 CLAMP

**TOBOL
CHERLEN**
diffuser
A9, C9, D9, E9

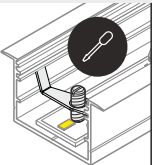
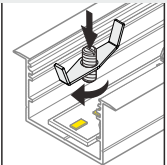
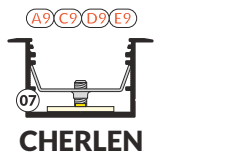
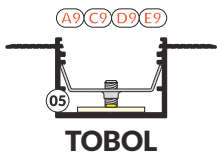
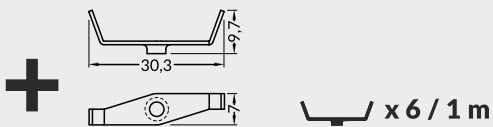

TOBOL / CHERLEN | reflector

**TOBOL
CHERLEN**
diffuser
A9, C9, D9, E9

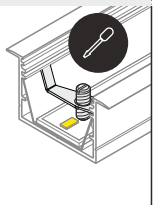
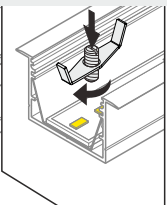
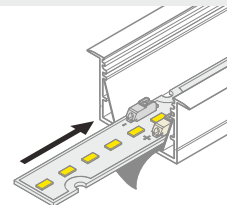
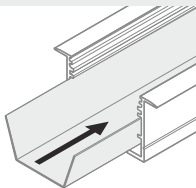
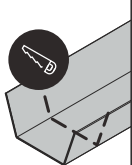
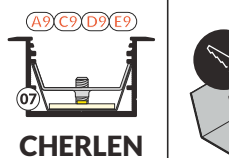
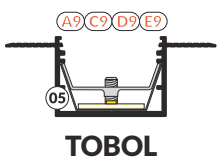
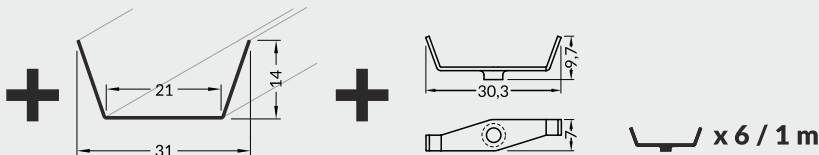

double-sided adhesive thermally
conductive tape 15 mm x 50 m

V

**KRISHNA
TOBOL
SANKURA
CHERLEN
diffuser**
A9, C9, D9, E9

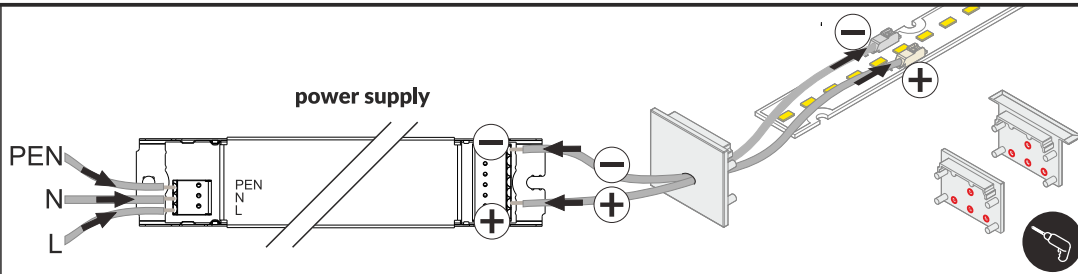
**VI**

**KRISHNA
TOBOL
diffuser**
A9

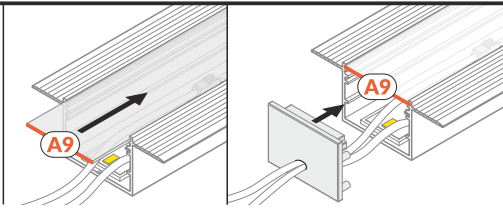

**SANKURA
CHERLEN
diffuser**
A9

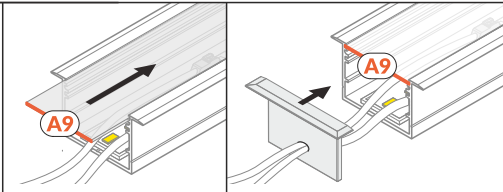

**KRISHNA
TOBOL
diffuser**
C9

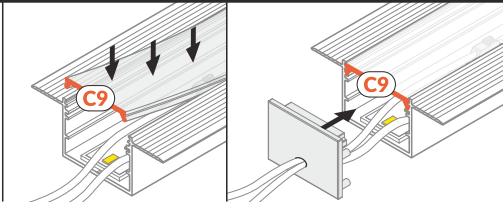

**SANKURA
CHERLEN
diffuser**
C9

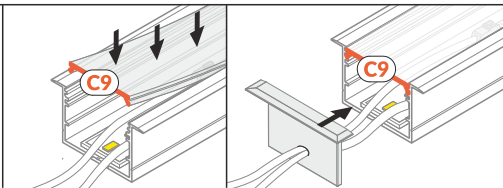

**KRISHNA
TOBOL
diffuser**
D9

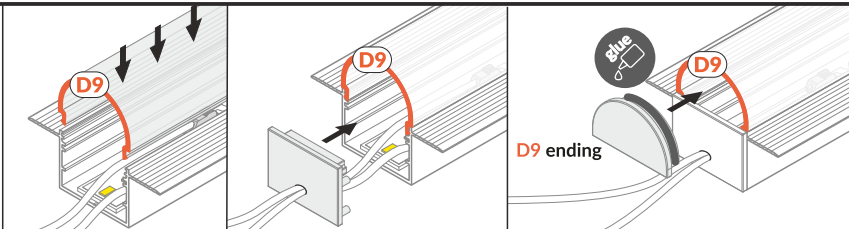

**SANKURA
CHERLEN
diffuser**
D9

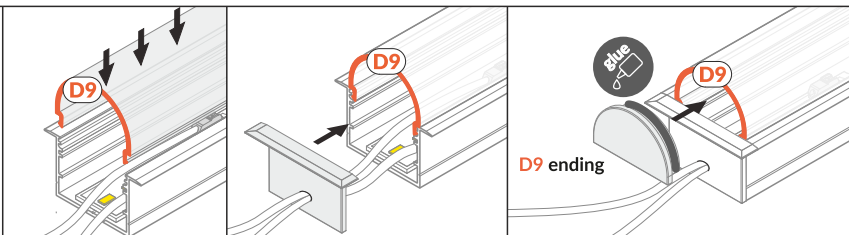

**KRISHNA
TOBOL
diffuser**
E9

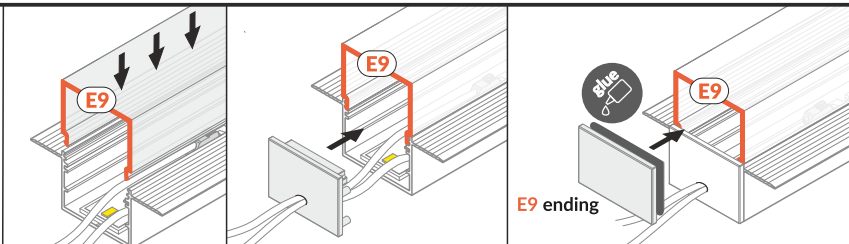

**SANKURA
CHERLEN
diffuser**
E9

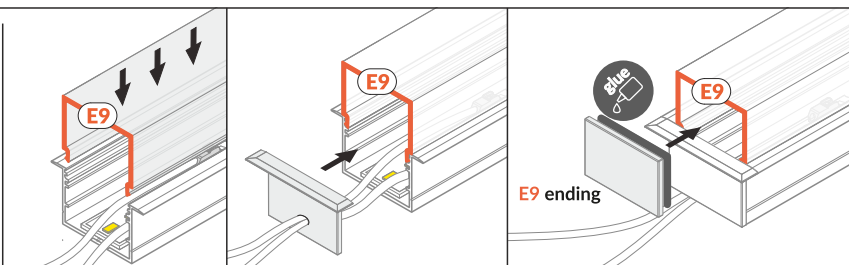

KRISHNA
diffuser
A9, C9, D9, E9

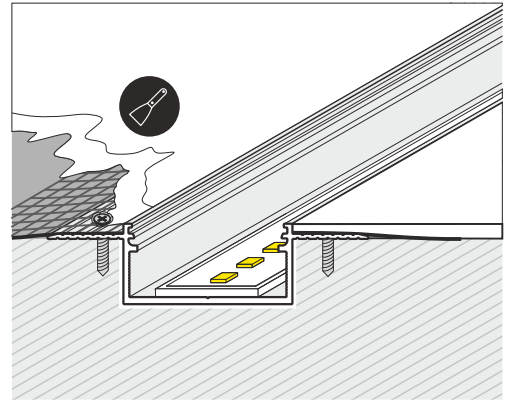
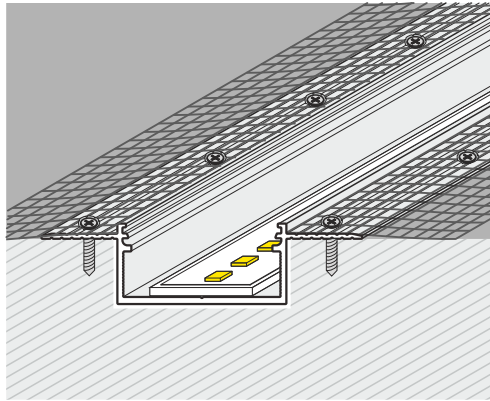
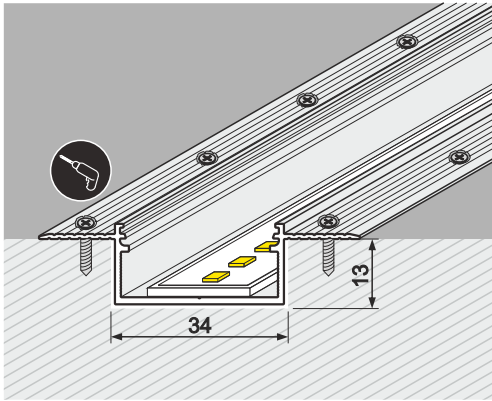

TOBOL
diffuser
A9, C9, D9, E9

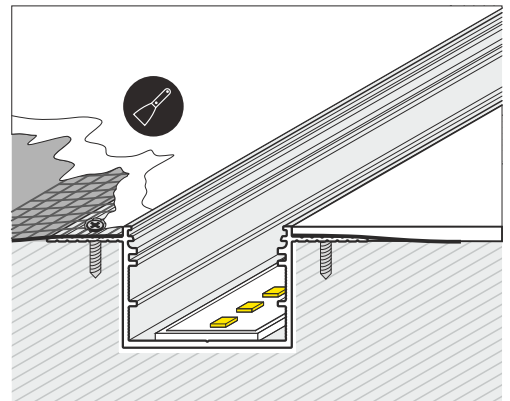
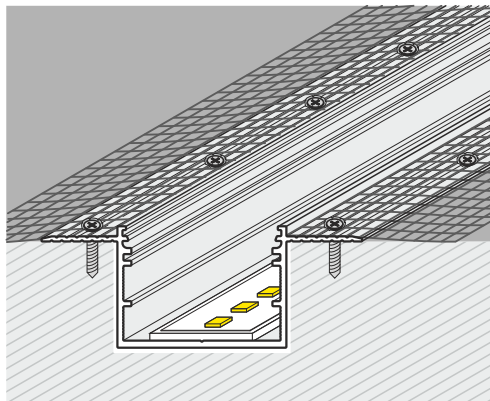
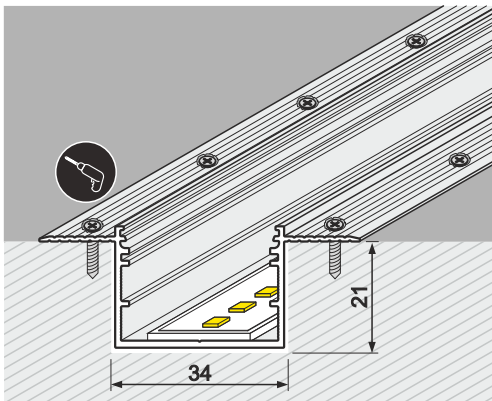

SANKURA
CHERLEN
 diffuser
 A9, C9, D9, E9

U9
 mounting plate

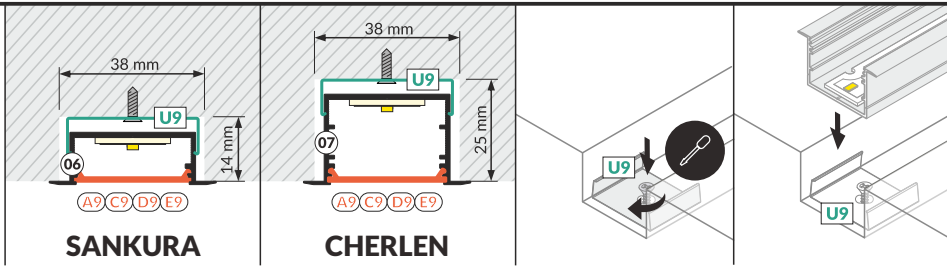

cone U9
 mounting plate

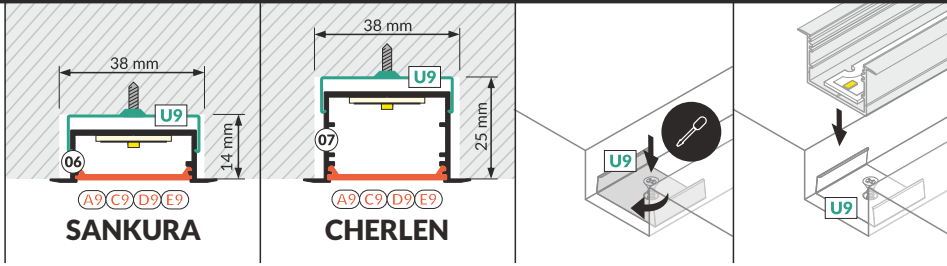

rack U9
 mounting plate

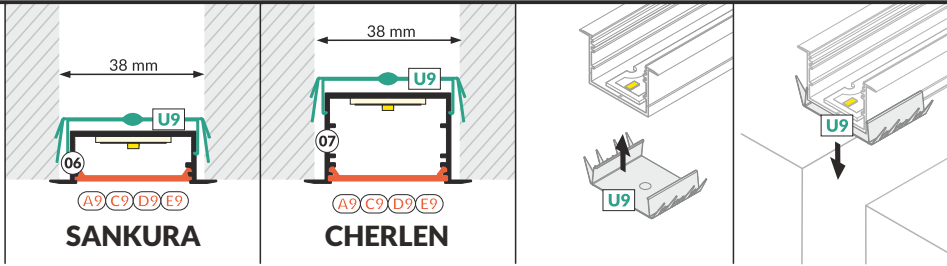

spring U9
 mounting plate

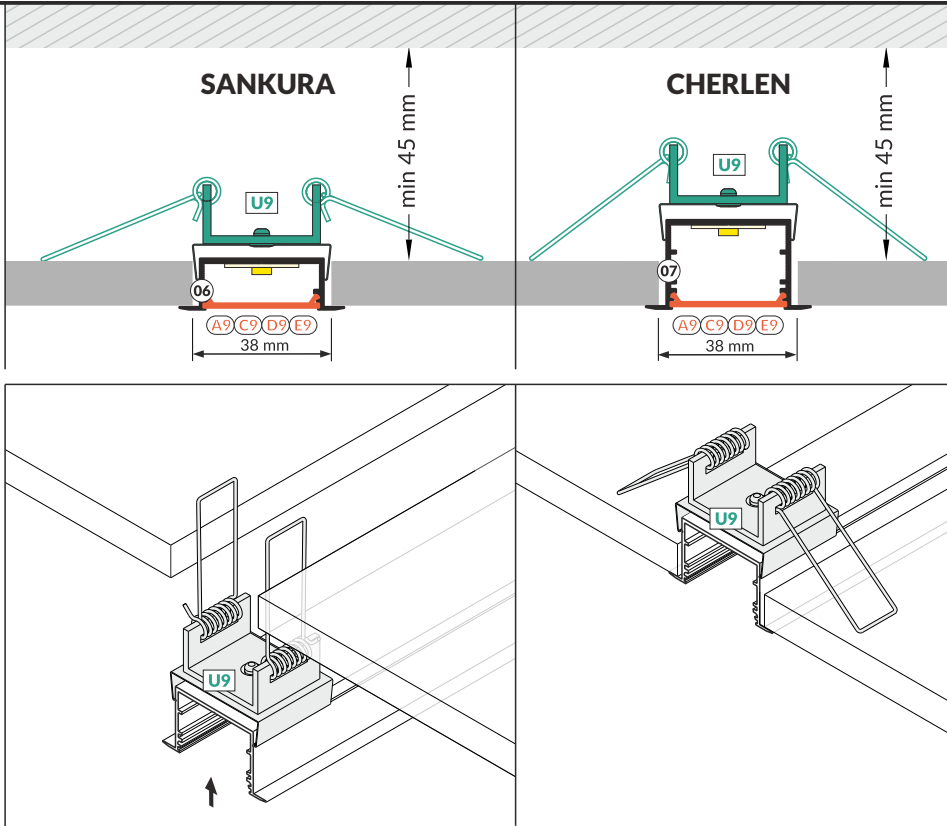

glue

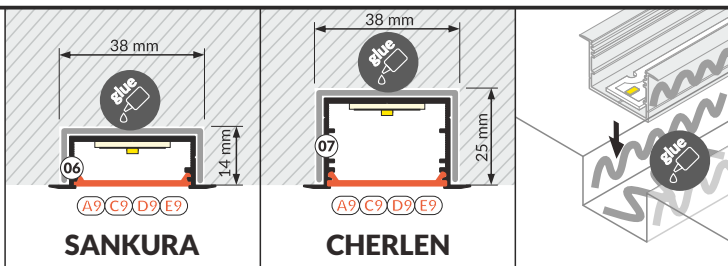

**TOBOL
CHERLEN**

diffuser
A9, C9, D9, E9

Available angular connectors:

TOBOL

1. TOBOL connector 60 deg
2. TOBOL connector 90 deg
3. TOBOL connector 90 deg bent
4. TOBOL connector 120 deg
5. TOBOL connector 135 deg
6. TOBOL connector 180 deg
7. TOBOL connector 270 deg bent

CHERLEN

1. CHERLEN 60 connector deg
2. CHERLEN 90 connector deg
3. CHERLEN 90 connector deg bent
4. CHERLEN 120 connector deg
5. CHERLEN 135 connector deg
6. CHERLEN 180 connector deg
7. CHERLEN 270 connector deg bent

CONNECTION POSSIBILITIES



60°



90°



90° bent



120°



135°



180°



270° bent

**TOBOL
CHERLEN**
diffuser

A9, C9, D9, E9

CHERLEN 180 connector deg

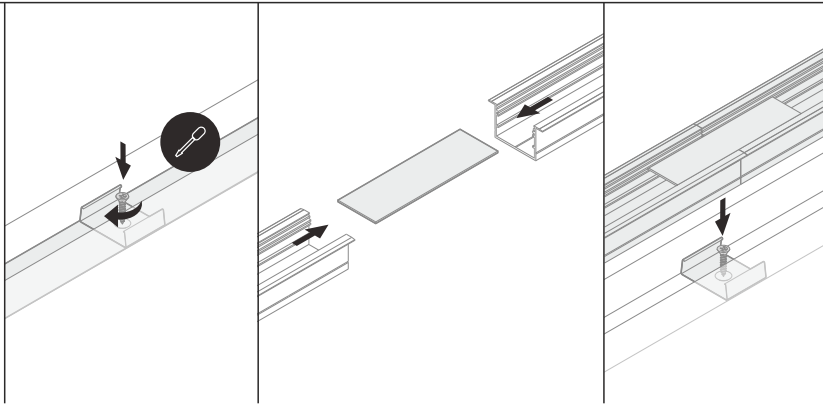

**TOBOL
CHERLEN**
diffuser

A9, C9, D9, E9

CHERLEN 90 connector deg

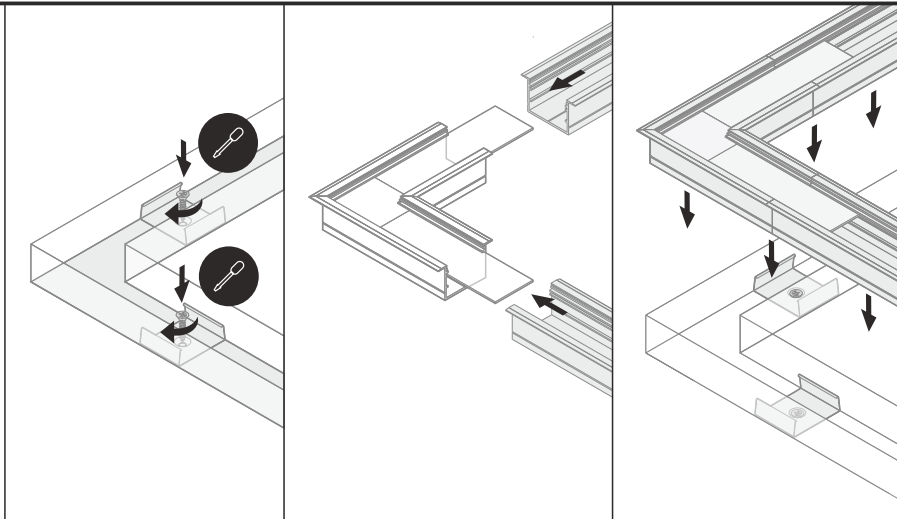

Every connector is installed similarly to NIL connector 90 deg

**TOBOL
CHERLEN**

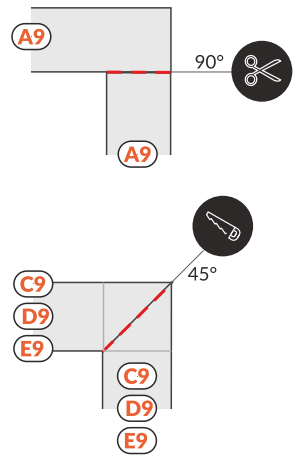

X POWER SUPPLY

**KRISHNA
TOBOL
SANKURA
CHERLEN**
diffuser
A9, C9, D9, E9

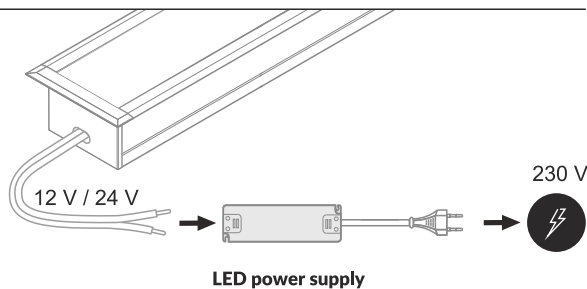

ACCESSORIES

power switches
controller + remote
movement sensors