

KONGO C SPECIAL APPLICATION PROFILE

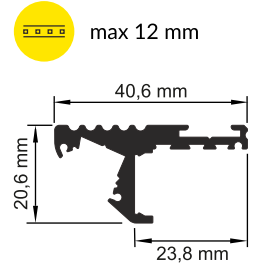

- C** C click cover
- 1** KONGO ending
- 2** KONGO anti-slip insert
- 3** KONGO LED cover
- 4** power supply cable
- 5** LED power supply

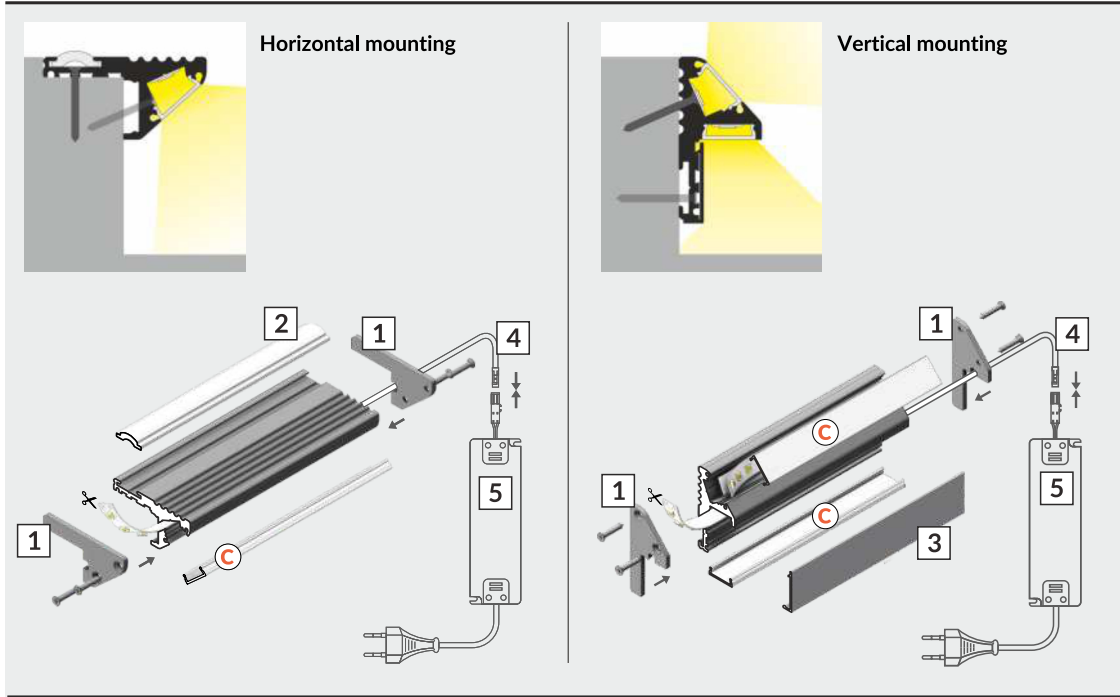
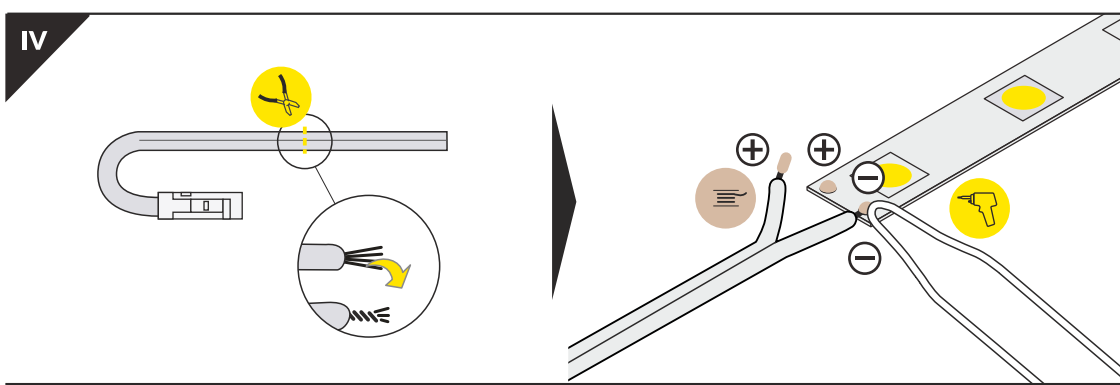
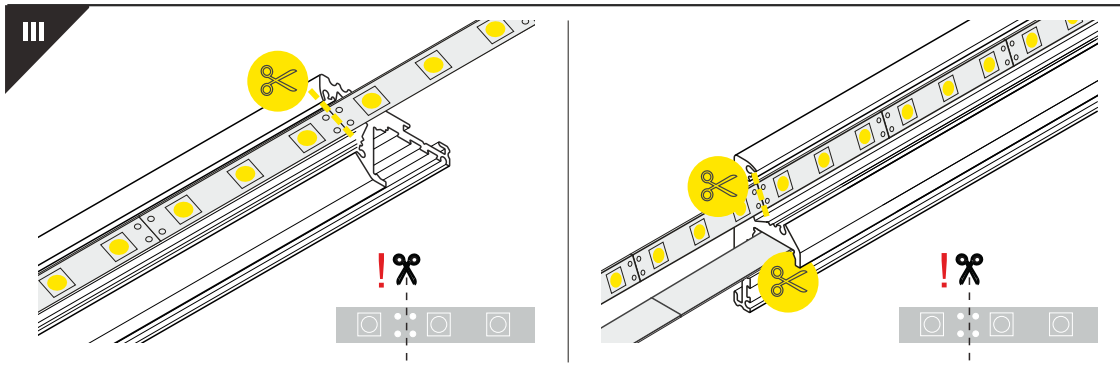
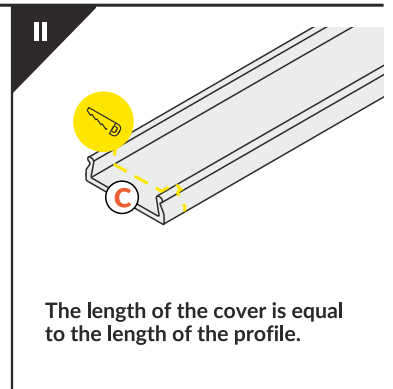
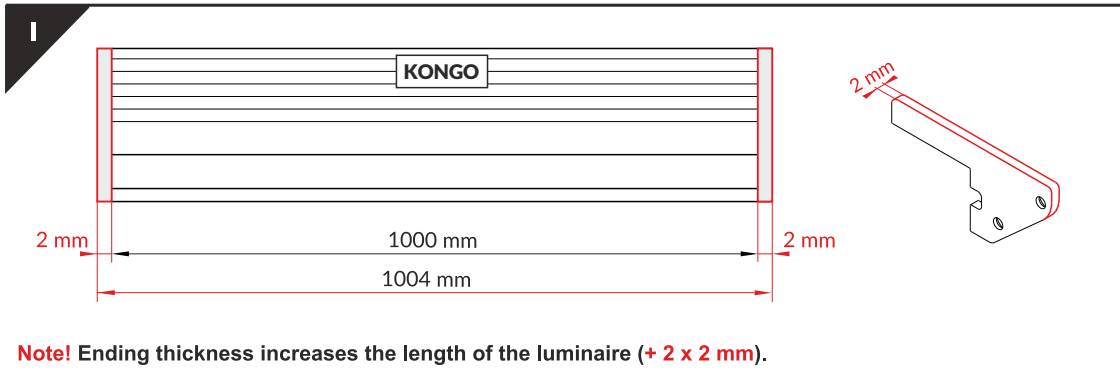

V

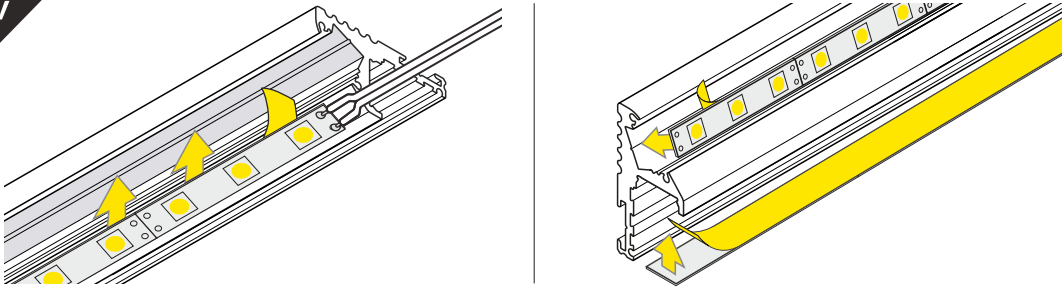

VI

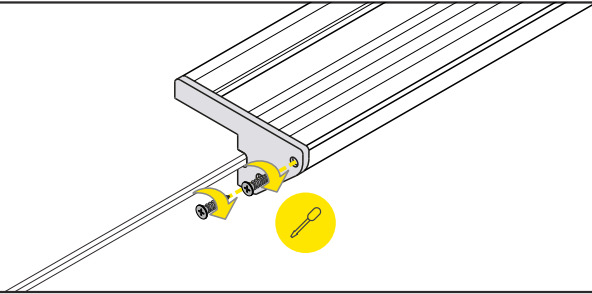

VII MOUNTING

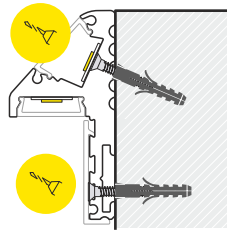
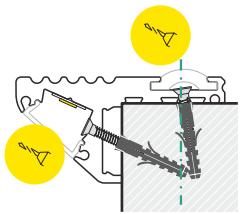

VIII

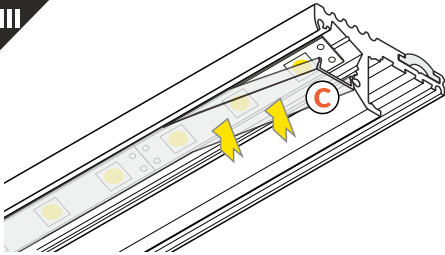

C click cover

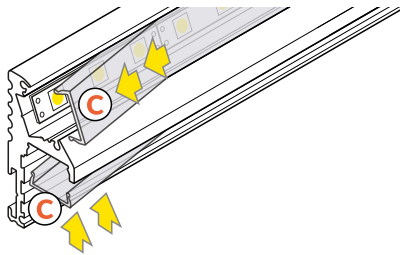

C click cover

IX

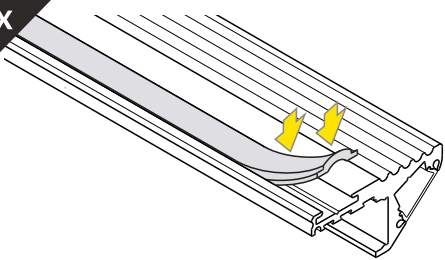

KONGO anti-slip cover

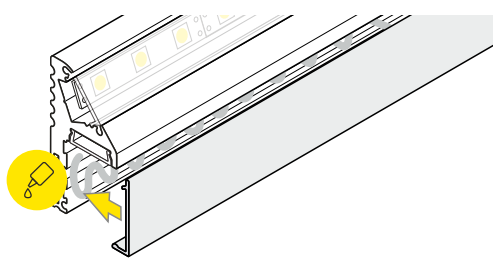

KONGO LED cover

X

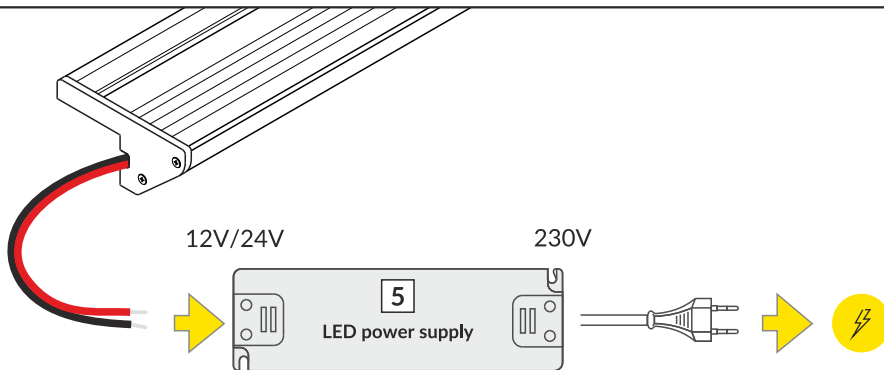

ACCESSORIES

- power switches
- controller + remote
- movement sensors